

Canon

PUB. DIE-0438-000

HD Camcorder
Quick Guide



LEGRIA
HF G30

PAL

MP4

HDMI

AVCHD
Progressive

WiFi
CERTIFIED

Important Usage Instructions

COPYRIGHT WARNING:

Unauthorized recording of copyrighted materials may infringe on the rights of copyright owners and be contrary to copyright laws.

To reduce the risk of electric shock, do not expose this product to dripping or splashing.

The Mains plug is used as the disconnect device. The Mains plug shall remain readily operable to disconnect the plug in case of an accident.

While using the compact power adapter, do not wrap it or cover it with a piece of cloth, and do not place it in confined narrow spaces.

CA-570 identification plate is located on the bottom.

European Union (and EEA) only.



These symbols indicate that this product is not to be disposed of with your household waste, according to the WEEE Directive (2002/96/EC), the Battery Directive (2006/66/EC) and/or your national laws implementing those Directives.

This product should be handed over to a designated collection point, e.g., on an authorized one-for-one basis when you buy a new similar product or to an authorized collection site for recycling waste electrical and electronic equipment (EEE) and batteries and accumulators. Improper handling of this type of waste could have a possible impact on the environment and human health due to potentially hazardous substances that are generally associated with EEE. Your cooperation in the correct disposal of this product will contribute to the effective usage of natural resources.

For more information about the recycling of this product, please contact your local city office, waste authority, approved scheme or your household waste disposal service or visit www.canon-europe.com/environment. (EEA: Norway, Iceland and Liechtenstein)

Complies with
IDA Standards
DB007671

This product is installed with the
WLAN Module which is certified to
standards set by IDA Singapore.

Precautions About the Battery Pack

DANGER!

Treat the battery pack with care.

- Keep it away from fire (or it might explode).
- Do not expose the battery pack to temperature higher than 60 °C. Do not leave it near a heater or inside a car in hot weather.
- Do not try to disassemble or modify it.
- Do not drop it or subject it to shocks.
- Do not get it wet.

REGIONS OF USE

LEGRIA HF G30 is in compliance (as of April 2013) with the radio signal regulations of the regions listed below. For details on other regions where they can be used, make inquiries with the contacts listed on the back side of this instruction manual.

REGIONS	Prohibited radio channels in outdoor use
Australia, Austria, Belgium, Bulgaria, Cyprus, Czech Republic, Denmark, Estonia, Finland, France, Germany, Greece, Hong Kong S.A.R., Hungary, Iceland, Ireland, Italy, Latvia, Liechtenstein, Lithuania, Luxembourg, Malta, Netherlands, Norway, Poland, Portugal, Romania, Russia, Slovakia, Slovenia, Spain, Sweden, Switzerland, United Kingdom	36 - 64ch
New Zealand	52 - 64ch
Singapore	Not prohibited

Statement on EC directive



Hereby, Canon Inc., declares that this RF400 is in compliance with the essential requirements and other relevant provisions of Directive 1999/5/EC.

Please contact the following address for the original Declaration of Conformity:

CANON EUROPA N.V.
 Bovenkerkerweg 59, 1158 XB Amstelveen, The Netherlands
 CANON INC.
 30-2, Shimomaruko 3-chome, Ohta-ku, Tokyo 146-8501, Japan

Model
 ID0026: LEGRIA HF G30

Important Note About the Memory



- Observe the following precautions while the ACCESS indicator is on or flashing. Failing to do so may result in permanent data loss or damage to the memory.
 - Do not open the memory card slot cover.
 - Do not disconnect the camcorder's power source or turn off the camcorder.
 - Do not change the camcorder's operating mode.

Trademark Acknowledgements

- SD, SDHC and SDXC Logos are trademarks of SD-3C, LLC.
- Microsoft and Windows are trademarks or registered trademarks of Microsoft Corporation in the United States and/or other countries.
- App Store, iPad, iPhone, iTunes and Mac OS are trademarks of Apple Inc., registered in the U.S. and other countries.
- HDMI, the HDMI logo and High-Definition Multimedia Interface are trademarks or registered trademarks of HDMI Licensing LLC in the United States and other countries.
- “AVCHD”, “AVCHD Progressive” and the “AVCHD Progressive” logo are trademarks of Panasonic Corporation and Sony Corporation.
- Manufactured under license from Dolby Laboratories.
- “Dolby” and the double-D symbol are trademarks of Dolby Laboratories.
- Google, Android, Google Play, YouTube are trademarks of Google Inc.
- Facebook is a registered trademark of Facebook, Inc.
- IOS is a trademark or registered trademark of Cisco in the U.S. and other countries and is used under license.
- The Twitter name and marks are trademarks of Twitter, Inc.
- Wi-Fi is a registered trademark of the Wi-Fi Alliance.
- Wi-Fi Certified, WPA, WPA2, and the Wi-Fi Certified logo are trademarks of the Wi-Fi Alliance.
- WPS as used on the camcorder’s settings, onscreen displays and in this manual signifies Wi-Fi Protected Setup.
- The Wi-Fi Protected Setup Identifier Mark is a mark of the Wi-Fi Alliance.
- Other names and products not mentioned above may be trademarks or registered trademarks of their respective companies.
- This device incorporates exFAT technology licensed from Microsoft.
- “Full HD 1080” refers to Canon camcorders compliant with high-definition video composed of 1,080 vertical pixels (scanning lines).
- This product is licensed under AT&T patents for the MPEG-4 standard and may be used for encoding MPEG-4 compliant video and/or decoding MPEG-4 compliant video that was encoded only (1) for a personal and non-commercial purpose or (2) by a video provider licensed under the AT&T patents to provide MPEG-4 compliant video. No license is granted or implied for any other use for MPEG-4 standard.



Package contents

- CA-570 Compact Power Adapter (incl. power cord and ferrite core) [①]
- BP-820 Battery Pack
- WL-D89 Wireless Controller (incl. CR2025 lithium button battery)
- HTC-100/S High Speed HDMI Cable [②]
- STV-250N Stereo Video Cable
- IFC-300PCU/S USB Cable [③]
- Lens hood with lens barrier [④]
- Lens cap [⑤]
- Wi-Fi Basic Setup Guide
-  **LEGRIA** CD-ROM
Contains the full-version Instruction Manual of the camcorder (PDF file) and an automatic installer for the software, **ImageBrowser EX** ( PDF 108). See the explanation on next page.
- Data Import Utility CD-ROM
Contains the software, **Data Import Utility** ( PDF 109)

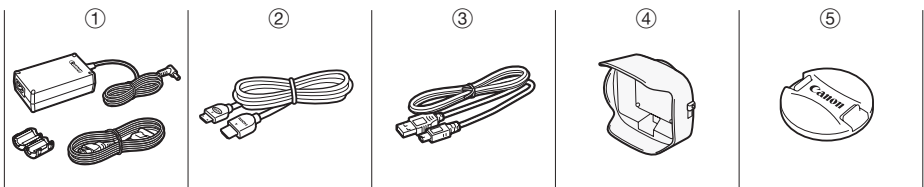



Table of Contents

05	Package contents
07	Onscreen Icons and Displays
11	Charging the Battery Pack
12	Basic Preparations
13	Using a Memory Card
14	Setting the Date/Time and Language
16	Shooting Video and Taking Photos
18	Playing Back Movies and Viewing Photos
20	Playback on a TV Screen
21	Saving Your Recordings
22	Abridged Specifications

About the Camcorder's Wi-Fi Functions

You can enjoy a variety of Wi-Fi functions with your camcorder. While these functions are beyond the scope of this Quick Guide, you can read the Wi-Fi Basic Setup Guide supplied with the camcorder to get you started. And you have the complete information in the full-version Instruction Manual (PDF file*).

About the Camcorder's PDF Instruction Manual

This guide will get you started and show you how to use the most basic functions of your camcorder to shoot video, take photos and play back your recordings (using the camcorder or connecting it to your TV). To learn more about the more advanced functions of your camcorder, to read important handling precautions and to consult the troubleshooting section if an error message is displayed, be sure to read the full-version Instruction Manual (PDF file*). In this Quick Guide, the  mark indicates reference page numbers in the PDF file.

* **Adobe® Reader®** 6 or later is required to view the PDF Instruction Manual.

Installing the Camcorder's Instruction Manual (PDF file)

- 1 **Insert the LEGRIA CD-ROM into the computer's disc drive.**
The installer panel appears.
- 2 **In the installer panel, click [Instruction Manual of the Camcorder] and select your language.**
- 3 **When the installation is complete, click [OK], then [Exit].**
The installer will save the camcorder's Instruction Manual (PDF file) on the computer and will create a shortcut icon on the desktop for easy access.

introduction

Onscreen Icons and Displays

Recording movies

AUTO mode

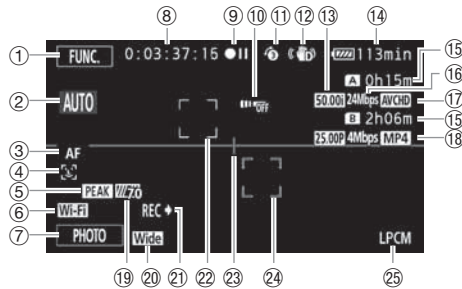

- ① Control button [FUNC.]: Open the FUNC. panel ([PDF 30](#))
- ② Smart AUTO* ([17](#))
* Available only in **AUTO** mode.
- ③ Autofocus mode ([PDF 52](#))
- ④ **Face detection:** You can have the camcorder automatically detect people's faces and use this information to adjust the focus and set the best exposure and color control settings for beautiful videos and photos. ([PDF 54](#))
- ⑤ Peaking ([PDF 52](#))
- ⑥ Wi-Fi Remote function ([PDF 120](#))
- ⑦ Control button [PHOTO] - Take a photo ([16](#))
- ⑧ While recording/during playback: Time code (hours : minutes : seconds : frames)
- ⑨ Operation ([PDF 155](#))
- ⑩ Remote sensor off ([PDF 150](#))
- ⑪ **Pre-recording:** The camcorder will start recording video 3 seconds before you press **[START/STOP]**, so you do not miss important shooting opportunities. ([PDF 88](#))
- ⑫ Image stabilizer ([PDF 60](#))
- ⑬ Frame rate ([PDF 47](#))
- ⑭ **Remaining battery time**
When the battery charge becomes low, replace the battery pack with a fully charged one.
- ⑮ Remaining recording time
[A]/[B] On the memory card
[A] / [B] Relay recording ([PDF 46](#))
When there is no more space on the currently selected memory card, [End] will be displayed in red next to the memory card's icon.
- ⑯ Recording mode ([16](#))
- ⑰ Movie format ([14](#))
- ⑱ Frame rate, recording mode and movie format for dual recording ([PDF 46](#))

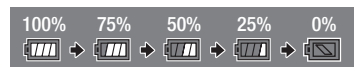

Onscreen Icons and Displays

- ⑲ Zebra pattern ([PDF](#) 64)
- ⑳ Conversion lens (Wide attachment shown) ([PDF](#) 145)
- ㉑ Recording command ([PDF](#) 149)
- ㉒ Face detection frame ([PDF](#) 54)
- ㉓ **Level marker:** Display onscreen markers to check your composition and make sure horizontal or vertical lines do not appear crooked in your recordings. ([PDF](#) 145)
- ㉔ **Tracking frame:** Touch a moving subject on the screen to keep it clearly in focus at all times. ([PDF](#) 54)
- ㉕ Linear PCM audio ([PDF](#) 44)

Recording movies

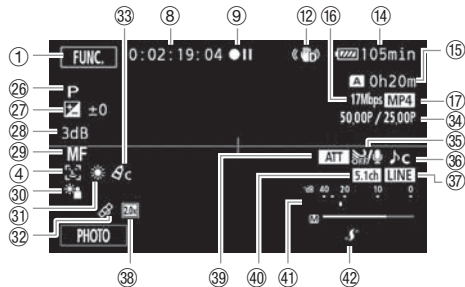
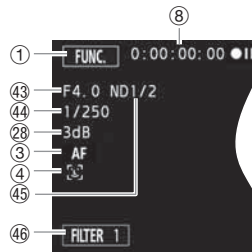
[M] mode**[CINEMA]** mode

- 26 Recording program ([PDF](#) 62, 64, 69)
- 27 **Exposure compensation:** Correct the exposure manually for a picture darker/brighter than the one obtained using the automatic exposure set by the camcorder. ([PDF](#) 65)
- 28 AGC limit ([PDF](#) 61); Gain (during the [M Manual Exposure] recording program) ([PDF](#) 64)
- 29 Manual focus ([PDF](#) 51)
- 30 Backlight correction ([PDF](#) 66)
- 31 **White balance:** Change the setting so different lighting conditions do not affect the colors in your recordings and white objects look truly white. ([PDF](#) 67)
- 32 GPS ([PDF](#) 90)
- 33 Image effects ([PDF](#) 71)
- 34 Slow & fast motion recording (shooting frame rate/playback frame rate) ([PDF](#) 48)
- 35 Wind screen ([PDF](#) 81)
- 36 Audio scene select ([PDF](#) 79)
- 37 External audio input from the MIC terminal ([PDF](#) 83)
- 38 Digital tele-converter ([PDF](#) 59)
- 39 Microphone attenuator ([PDF](#) 145)
- 40 Directionality of the optional SM-V1 Surround Microphone ([PDF](#) 145)
- 41 **Audio level indicator:** Manually adjust the audio recording level. ([PDF](#) 80)
- 42 Mini advanced shoe ([PDF](#) 75)
- 43 Aperture value ([PDF](#) 62, 64)
- 44 Shutter speed ([PDF](#) 62, 64)
- 45 ND filter ([PDF](#) 145)
- 46 Control button [FILTER 1] - **Cinema-look filters:** Use cinema-look filters to create unique movies with distinctive looks. ([PDF](#) 49)

 **Playing movies (during playback)**

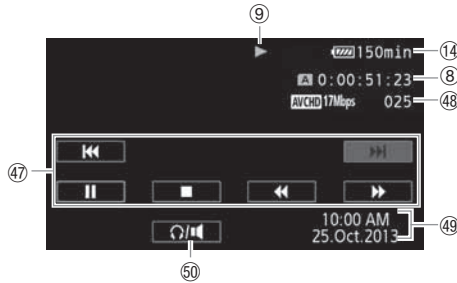

- 47 Playback control buttons ([PDF](#) 19)
- 48 Scene number
- 49 Date/Time ([PDF](#) 32)
- 50 Volume controls ([PDF](#) 96)

 **Viewing photos**

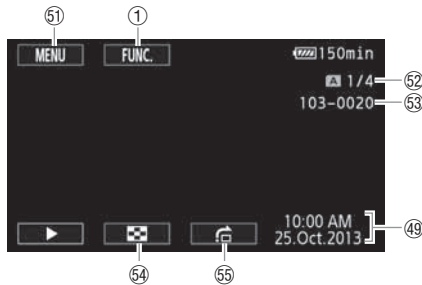

- 51 Control button [MENU]: Open the setup menus ([PDF](#) 31, 143)
- 52 Current photo / Total number of photos
- 53 File number ([PDF](#) 147)
- 54 Control button [Play] - Return to the photo index screen ([PDF](#) 105)
- 55 Control button [Photo] - Photo jump ([PDF](#) 105)

step 1

Charging the Battery Pack

The camcorder can be powered with a battery pack or directly using the compact power adapter. When you use the compact power adapter, the power of the battery pack will not be consumed. Charge the battery pack before use.

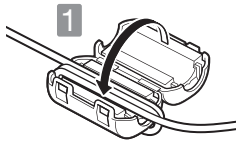

1 Attach the ferrite core to the compact power adapter cable.

- ① Attach the ferrite core about 6 cm from the plug end (the plug to be connected to the camcorder).
- ② Pass the cable through the center of the core and wrap it around the core, then close the unit until it clicks shut.

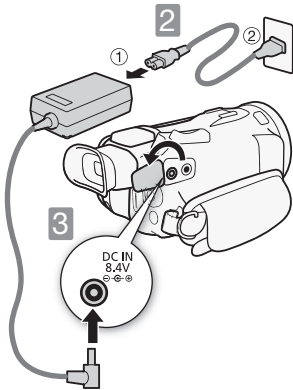

2 Connect the compact power adapter.

- ① Connect to the adapter.
- ② Plug into a power outlet.

3 Connect the camcorder.

- ① Plug into the DC IN terminal.

4 Insert the battery pack.

- ① Press softly into the battery attachment unit.
- ② Slide up until it clicks in place.



Charging will start when the camcorder is turned off.

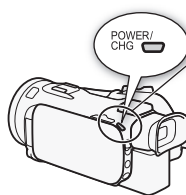

Indicator off
(camcorder turned off)
Red indicator on
(charging)
Indicator off
(battery pack fully charged)

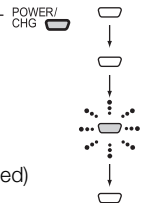

Charging times

Charging the supplied BP-820 Battery Pack will take approximately 4 hours 35 minutes. A fully charged battery pack will allow for 1 hour 40 minutes of recording under typical conditions or 4 hours 45 minutes of playback.*

* For movies recorded at 17 Mbps. Given times are approximate and vary according to recording mode and charging, recording or playback conditions.

See *Charging, Recording and Playback Times* ([PDF](#) 174) for details.

! IMPORTANT

- The battery pack will be charged only when the camcorder is off.
- Do not connect to the camcorder's DC IN terminal or to the compact power adapter any electrical equipment that is not expressly recommended for use with this camcorder.
- Do not connect the supplied compact power adapter to voltage converters or special power sources such as those on aircraft, DC-AC inverters, etc.

i NOTES

- We recommend charging the battery pack in temperatures between 10 °C and 30 °C. If either the ambient temperature or the battery pack's temperature is outside the range of approx. 0 °C to 40 °C, charging will not start.
- If remaining battery time is an issue, you can power the camcorder using the compact power adapter so the battery pack will not be consumed.
- Charged battery packs continue to discharge naturally. Therefore, charge them on the day of use, or the day before, to ensure a full charge.
- We recommend that you prepare battery packs to last 2 to 3 times longer than you think you might need.

step 2

Basic Preparations

Before you begin, make basic adjustments and learn about a few of the frequently-used parts. See *Preparing the Camcorder* (PDF 23) for details. See *Handling Precautions* (PDF 167), *Cleaning* (PDF 171) for important information about how to take care of the touch screen.

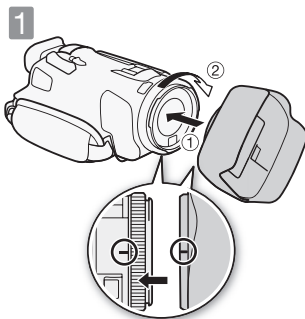

1 Attach the lens hood.

Place the lens hood on the front of the lens so that the groove on the lens hood is aligned with the bottom of the lens (①), and then turn the lens hood clockwise (②).

- Be careful not to deform the lens hood.
- Make sure that the lens hood is aligned with the thread.

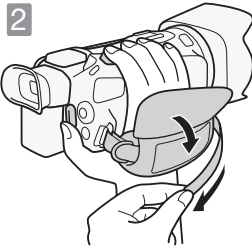

- 2** Fasten the grip belt.
Adjust it so you can reach the zoom rocker with your index finger, and **START/STOP** with your thumb.

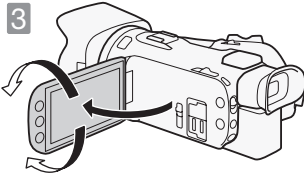



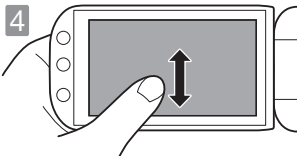

- 3** Open the OLED panel and adjust the angle.
- ① Rotate it up to 90 degrees down (for example, to record with your hand extended above a crowd).
 - ② Rotate it up to 180 degrees toward the lens (for example, to record video of yourself).
 - ③ If it is difficult to use the OLED screen, you can use the viewfinder, which can be tilted 45 degrees upward.



- 4** Become familiar with the touch screen.
- In addition to touching buttons to select items, you can also drag your finger across the screen for operations such as scrolling menus. While touching the screen, swipe your finger across the screen.
- Alternatively, you can use the joystick to navigate the menus.

step 3

Using a Memory Card

Use commercially available  SD,  SDHC (SD High Capacity) or  SDXC (SD eXtended Capacity) memory cards. Make sure you use a compatible memory card. See *Memory Cards Compatible for Use with the Camcorder* ( PDF) 34) for memory cards that can be used.

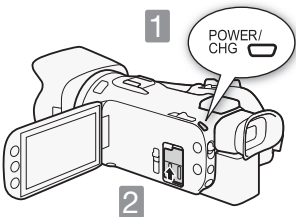

- 1** Turn off the camcorder.
Set to OFF. Make sure the indicator is off.
- 2** Open the double memory card slot cover.

3 Insert the memory card into one of the memory card slots and close the double memory card slot cover.

- 1 Push the memory card into the memory card slot.
- 2 Securely close the cover. Do not force it closed if the memory card is not correctly inserted.



! IMPORTANT

- Memory cards have front and back sides that are not interchangeable. Inserting a memory card facing the wrong direction can cause a malfunction of the camcorder.
- For important information regarding the use of SDXC memory cards be sure to refer to *SDXC Memory Cards* (PDF 34).
- Initialize memory cards when you use them with this camcorder for the first time.
See *Initializing a Memory Card* (PDF 35) for details.

i NOTES

- **To remove the memory card:** Push the memory card once to release it. When the memory card springs out, pull it all the way out.

step 4

Setting the Date/Time and Language

When you turn on the camcorder for the first time, you will need to set the date and time before using the camcorder. You can also change the date format and time zone. (For your convenience, you can do so after changing the language to your preference.)

See *Changing the Time Zone* (PDF 33) for details.

1 Set to CAMERA.

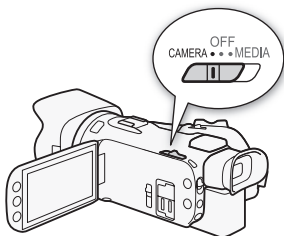

When the internal clock is not set, the [Date/Time] screen will appear.

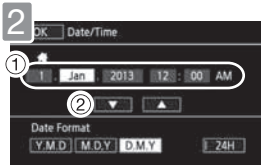

- 2** Change the date/time.
- ① Touch a field you want to change.
 - ② Touch [▼] or [▲] to change the field.

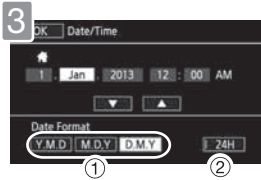

- 3** Select your preferred date/time format.
- ① Touch one of the control buttons.
 - ② Touch to use 24-hour clock.

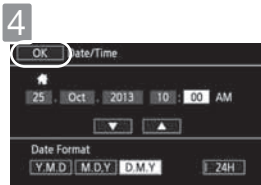

- 4** Touch [OK].

- 5** Select the language used for menus and onscreen displays. You can select one of 27 languages to display the camcorder's menus and onscreen displays. Select the language of your preference using the menu.

See *Using the Menus* (PDF 30) for details.

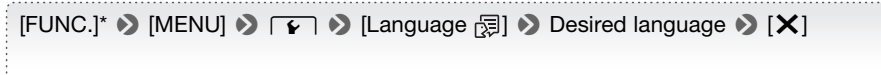

* Only when performing the procedure in **CINEMA** mode.



English is the default language



i NOTES

- If you changed the language by mistake, look for the menu option with the mark.

basic recording

Shooting Video and Taking Photos

In **AUTO** mode you can easily record movies and photos. You do not need to worry about any settings or menu options - the camcorder will select the most appropriate settings automatically.

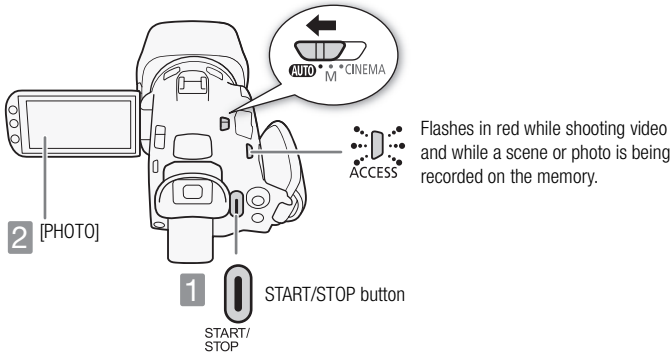

- 1 Start recording movies.**
Press to start recording. Press again to pause the recording and record the video on the memory card as one scene.
- 2 Take a photo.**
Touch [PHOTO] on the screen.

Using the Zoom to Frame the Subject

Use the zoom rocker or the onscreen zoom controls. To zoom out, zoom toward the **W** (wide angle) end. To zoom in, zoom toward the **T** (telephoto) end.

Touch [FUNC.] ➤ [ZOOM] to display the onscreen zoom controls

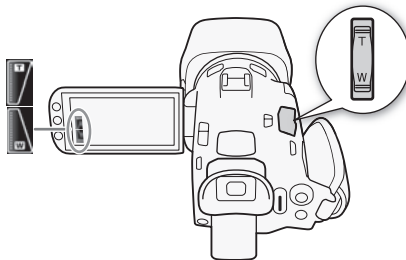

Selecting Video Recording Options

You can record movies in either AVCHD or MP4 format. Select AVCHD when you want to play back your movies with fantastic picture quality. Select MP4 when you want the versatility of uploading your movies to the Web or playing them back on devices such as smartphones and tablets.

[FUNC.] ➤ [MENU] ➤  ➤ [Movie Format] ➤ Desired movie format

You can also set the recording mode (video and audio quality). For AVCHD movies, you can select up to 28 Mbps, with two recording modes featuring linear PCM audio. For MP4 movies, you can record up to 35 Mbps.

[FUNC.] ➤ [MENU] ➤  ➤ [Recording Mode] ➤ Desired recording mode

See *Selecting the Movie Format (AVCHD/MP4)* ([PDF 36](#)) for details. See *Selecting the Video Quality* ([PDF 44](#)) for approximate recording times.

Using Wi-Fi to Record Movies with Your Smartphone or Tablet

You can use devices such as smartphones and tablets to remotely control the camcorder. While you view the camcorder's image on the device's screen, you can record movies.

See *Remote Operation Via the Wi-Fi Remote Application* ([PDF 120](#)) for details.

NOTES

- **Smart AUTO:** In **AUTO** mode, just point the camcorder and Smart AUTO will automatically select the best settings for your subject and the scene you want to use. One of 38 icons will appear depending on the characteristics of the subject, background, lighting conditions, etc.
See *Smart AUTO* ([PDF 39](#)) for details.
- **Intelligent IS:** In **AUTO** mode, the camcorder will automatically select the best IS setting for the situation.
See *Intelligent IS* ([PDF 40](#)) for details.
- Use **M** or **CINEMA** mode to access advanced functions and to change various settings up to your preferences.
See *Recording in M (Manual) Mode* ([PDF 42](#)), *CINEMA Mode and Cinema-Look Filters* ([PDF 49](#)) and all through the rest of the *Recording* chapter ([PDF 37](#)) for details.
- **About the zoom:** The camcorder features 20x optical zoom. When recording movies, you can also use the 400x digital zoom.
See *Digital Zoom* ([PDF 144](#)) for details.
- **About the zoom speed:**
 - Onscreen zoom controls: depends on where you touch within the zoom control.
 - Zoom rocker: variable speed. That is, the zoom speed depends on how you press the rocker: press gently for slower zooms; press harder for faster zooms. You can also change the zoom speed to one of three constant speeds.
 See *Zooming* ([PDF 56](#)) for details.
- In most situations, keep at least 60 cm away from the subject. The minimum focusing distance at full wide angle is 1 cm.

When you have finished recording

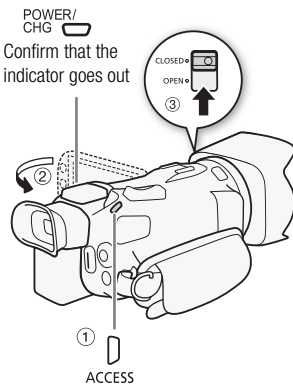

Make sure the camcorder has finished writing the scenes or photos on the memory before turning it off.

- ① Check that the indicator is off.
- ② Close the OLED panel.
- ③ Close the lens barrier.

basic playback

Playing Back Movies and Viewing Photos

Your recordings are conveniently organized in different index screens for AVCHD movies, MP4 movies and photos. You can change the index screen and easily find the recording you want to play back.

See *Playing Back Video* ([PDF](#) 95) and *Viewing Photos* ([PDF](#) 105) for details.

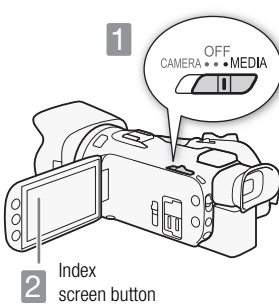

- 1 Set to MEDIA.

2 Change the index screen, if necessary.

Movies: Touch the index screen button ([A] **AVCHD**) to open the index selection screen. Next, touch the tab that indicates the memory card with the desired scene ([A] or [B]) and then touch the control button of the desired index screen.



3 Look for the scene or photo you want to playback.
Drag your finger left or right for the next/previous index page.

4 Touch the desired scene or photo to playback.

Movies: The selected scene is played back. Playback continues until the end of the last scene in the index screen. Touch the screen during playback to display the playback controls.

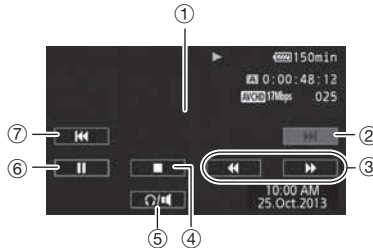

- ① Touch anywhere else to hide the playback controls
- ② Next scene
- ③ Fast playback* (touch again to increase the speed)
- ④ Stop
- ⑤ Volume controls
- ⑥ Pause (touch again to resume playback)
- ⑦ Beginning of the scene (double-tap to jump to the previous scene)

* In playback pause, these controls are replaced by the slow playback controls.

Photos: The selected photo is displayed in single photo view. Drag your finger left/right to browse through the photos one by one. Touch the screen to display the playback controls.

Using Wi-Fi to View Recordings

You can wirelessly upload recordings to an iOS device, view recordings from the Web browser of your smartphone or tablet, and more.

See *Wi-Fi Functions* ([PDF](#) 117) for details.

! IMPORTANT

- You may not be able to play back with another device the movies you recorded on the memory card with this camcorder. In such case, play back the movies on the memory card using this camcorder.

i NOTES

- When playing back movies, depending on the recording conditions, you may notice brief stops in video or sound playback between scenes.

basic playback

Playback on a TV Screen

Connect your camcorder to a TV to enjoy your recordings with family and friends. Make sure the camcorder and TV are turned off before you start.

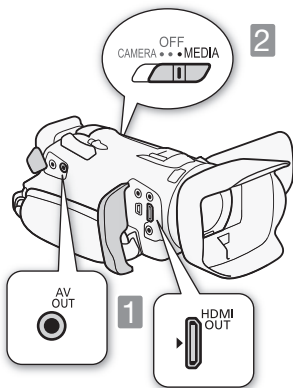

- 1** Connect the camcorder to the TV.
Select the appropriate connection according to the input terminals on your TV. The HDMI connection has higher picture quality (HD) than the composite video connection (SD).
- 2** Turn on the TV and then the camcorder.
Set to MEDIA.
- 3** Play back your movies or photos as described in the previous pages.

1 HDMI connection: All digital, high-definition connection; output only.

See *Connection Diagram* ([PDF](#)) 102 for details about additional settings.

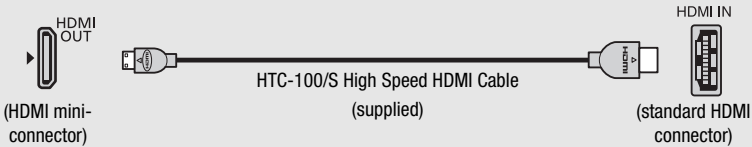

2 Composite video connection: Analog, standard-definition connection; output only.

See *Connection Diagram* ([PDF](#)) 102 for details about additional settings.

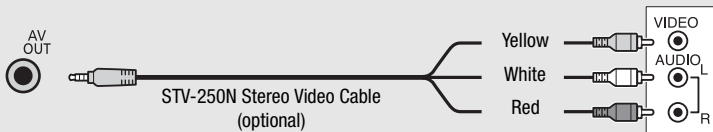

i NOTES

- The illustrations are for reference only. The layout of terminals on your TV may be different.
- We recommend powering the camcorder using the compact power adapter.
- Adjust the volume using the TV.
- When you play back 16:9 movies on standard TV sets with a 4:3 aspect ratio, the TV set will switch automatically to widescreen mode if it is compatible with the WSS system. Otherwise, change the aspect ratio of the TV manually.

See *[TV Type]* ([PDF](#)) 146 for details.

- Using a SCART adapter, you can connect the camcorder also to the SCART terminal on the TV. See *Connection Diagram* ([PDF](#)) 102 for details.

external connections

Saving Your Recordings

It is recommended that you periodically save your recordings.

Data Import Utility

- For AVCHD movies. Refer to the Software Guide (PDF file) of the supplied software for details about installing and using the software.

ImageBrowser EX

- For MP4 movies and photos. This software allows you to save and manage MP4 movies and photos. Refer to *Saving MP4 Movies and Photos Using ImageBrowser EX* ([PDF](#) 109) for details about installing the software.

specifications

Abridged Specifications

The specifications given here are an **abridged version** of the full specifications of the camcorder. Be sure to read the full version of the instruction manual for the complete information.

See *Specifications* ([PDF](#) 178) for details.

Power supply (rated)

7.4 V DC (battery pack), 8.4 V DC (compact power adapter)

Power consumption

4.2 W (17 Mbps, AF on, OLED normal brightness)

Optional Accessories

Canon offers a wide range of optional accessories for your camcorder.

See *Optional Accessories* ([PDF](#) 173) for details.

Use of genuine Canon accessories is recommended.

This product is designed to achieve excellent performance when used with genuine Canon accessories. Canon shall not be liable for any damage to this product and/or accidents such as fire, etc., caused by the malfunction of non-genuine Canon accessories (e.g., a leakage and/or explosion of a battery pack). Please note that this warranty does not apply to repairs arising out of the malfunction of non-genuine Canon accessories, although you may request such repairs on a chargeable basis.

This mark identifies genuine Canon video accessories. When you use Canon video equipment, we recommend Canon-brand accessories or products bearing the same mark.





Canon Europa N.V.

Bovenkerkerweg 59, 1185 XB Amstelveen, The Netherlands
www.canon-europa.com

Canon UK Ltd

CCI Service Centre, Unit 130
Centennial Park, Borehamwood, Hertfordshire, WD6 3SE, United Kingdom
Telephone 0844-369-0100

Canon Australia Pty Ltd

Tel: 13-13-83 (within Australia only)
(61) 02-9805-2555
www.canon.com.au

Canon New Zealand Ltd

Tel: 0800-222-666 (within New Zealand only)
(64) 09-489-0300
www.canon.co.nz

Canon Singapore Pte. Ltd

1 HarbourFront Avenue, #04-01 Keppel Bay Tower, Singapore 098632
Tel: (65) 6799 8888
Fax: (65) 6799 8882

Canon Hongkong Company Ltd

19/F, The Metropolis Tower, 10 Metropolis Drive,
Hung Hom, Kowloon, Hong Kong
Tel: +852 3191 2333, Fax: +852 2428 3963

Canon Latin America, Inc.

Sales & Enquiries:
One Canon Park, Melville, NY 11747 USA

Visit your local Canon Web site to download the latest version of this Quick Guide.
For support concerning the supplied software, contact your local Canon Service Center.