



HP LaserJet Pro Color MFP M476

Troubleshooting Manual



M476dn
M476dw
M476nw



www.hp.com/support/colorljMFPM476
www.hp.com/support



HP LaserJet Pro Color MFP M476 Printer

Troubleshooting Manual

Copyright and License

© 2014 Copyright Hewlett-Packard Development Company, L.P.

Reproduction, adaptation, or translation without prior written permission is prohibited, except as allowed under the copyright laws.

The information contained herein is subject to change without notice.

The only warranties for HP products and services are set forth in the express warranty statements accompanying such products and services. Nothing herein should be construed as constituting an additional warranty. HP shall not be liable for technical or editorial errors or omissions contained herein.

Edition 1, 4/2014

Trademark Credits

Microsoft®, Windows®, Windows® XP, Windows Vista®, Windows® 7, Windows® 8, and Windows® 8.1 are U.S. registered trademarks of Microsoft Corporation.

ENERGY STAR and the ENERGY STAR mark are registered U.S. marks.

Conventions used in this guide

 **TIP:** Tips provide helpful hints or shortcuts.

 **NOTE:** Notes provide important information to explain a concept or to complete a task.

 **CAUTION:** Cautions indicate procedures that you should follow to avoid losing data or damaging the product.

 **WARNING!** Warnings alert you to specific procedures that you should follow to avoid personal injury, catastrophic loss of data, or extensive damage to the product.

Table of contents

1 Theory of operation	1
Basic operation	2
Major systems	2
Product components	2
Sequence of operation	3
Formatter-control system	4
Sleep Delay	4
Input/output	4
USB	4
10/100 networking	4
Fax	4
USB hosts	5
Memory	5
Flash memory	5
Random access memory	5
Nonvolatile memory	5
Memory Enhancement technology	5
Wireless radio	5
PJM overview	5
LEDM overview	6
ACL overview	6
PML	6
Control panel	6
NFC	6
Engine control system	7
DC controller	8
Power supply	9
Protective function	9
Power saving	10
Fuser control	10
Fuser control circuit	11
Fuser protective function	12

Fuser failure detection	13
High-voltage power supply	14
Laser/scanner system	15
Laser failure detection	15
Image-formation system	16
Image-formation process	16
Overview	16
Latent-image formation stage	17
Step 1: primary charging	17
Step 2: laser-beam exposure	18
Developing stage	18
Step 3: development	18
Transfer stage	19
Step 4: primary transfer	19
Step 5: secondary transfer	19
Step 6: separation from the drum	20
Fusing stage	20
Step 7: fusing	20
ITB cleaning stage	21
Step 8: ITB cleaning	21
Drum cleaning stage	22
Step 9: drum cleaning	22
Developing roller engagement/disengagement control	22
Pickup-and-feed system	23
Jam detection	25
Pad transfer	25
Multiple-feed prevention	26
Scanning and image capture system	27
Scanner power-on sequence of events	27
Copy or scan sequence of events	28
Scanner operation	28
ADF operation	30
ADF duplex operation	30
ADF paper path and ADF sensors	30
ADF jam detection	31
ADF jam clearance	32
Fax functions and operation	33
Computer and network security features	33
PSTN operation	33
Receive faxes when you hear fax tones	33
Distinctive ring function	34

Fax by using Voice over IP services	34
The fax subsystem	35
Fax card in the fax subsystem	35
Safety isolation	35
Safety-protection circuitry	35
Data path	35
Hook state	36
Downstream current detection	36
Hook switch control	36
Ring detect	36
Line current control	36
Billing- (metering-) tone filters	37
Fax page storage in flash memory	37
Stored fax pages	37
Advantages of flash memory storage	37
USB flash drive	38
2 Solve problems	39
Solve problems checklist	40
Menu structure	42
Configuration report	43
Troubleshooting process	44
Determine the problem source	44
Power subsystem	45
Power-on checks	45
Control-panel checks	45
Tools for troubleshooting	46
Individual component diagnostics	46
Tools for troubleshooting: LED diagnostics	46
Network LEDs	46
Control panel LEDs	46
Tools for troubleshooting: Engine diagnostics	47
Engine-test button	47
Drum rotational check	47
Half self-test functional check	48
Diagrams	49
Diagrams: Formatter connections	49
Diagrams: Location of major components	50
Major components	50
Motors and fans	52
Rollers	53

PCAs	54
Optional 250-sheet cassette	55
Diagrams: General timing chart	56
Diagrams: Circuit diagram	57
Diagrams: CPU/ASIC diagrams	58
Diagrams: HVT/Toner EMP diagram	60
Diagrams: Driver PCA diagram	61
Diagrams: Duplexer PCA diagram	62
Diagrams: FSR diagram	63
Print-quality troubleshooting tools	64
Print-quality troubleshooting tools: Repetitive defects ruler	64
Tools for troubleshooting: Control panel menus	65
Setup menu	65
HP Web Services menu	65
Reports menu	66
Self Diagnostics menu	66
Fax Setup menu	67
System Setup menu	69
Service menu	72
Network Setup menu	74
Quick Forms menu	75
Fax Menu	75
Copy Menu	77
Tools for troubleshooting: Interpret control panel messages	78
Control panel message types	78
Control panel messages	79
10.100X Supply Memory Error	79
30.XXXX Scanner Error	80
49 Error, Turn off then on	80
50.XXXX Fuser Error	81
51.XX and 52.XX Error To continue turn off then on	82
54.0100 — 54.1599 Error	82
55.1 DC controller Memory Error	83
57 Fan Error, Turn off then on	83
58.04 Error Turn off then on	83
59.XXXX Error Turn off then on	84
60.XXXX Error Turn off then on	85
79 Error Turn off then on	85
Device is busy. Try again later.	86
Document feeder mispick. Reload.	86
Document feeder jam. Clear and reload.	87

Fax is busy. Canceled send.	87
Fax receive error.	87
Fax Send error.	88
Fax storage is full. Canceling the fax send/receive.	88
Front door open.	89
Jam in Tray 1, Clear jam and then press OK	89
Jam in Tray 2, Clear jam and then press OK	89
Jam in Tray 3, Clear jam and then press OK	90
Load paper	90
Load Tray 1 <TYPE> <SIZE>, Press OK to use available media	90
Load Tray 1, <PLAIN> <SIZE> / Cleaning mode, OK to start	90
Load tray <X> Press [OK] for available media	90
No dial tone.	91
No fax detected.	91
The product is unable to calibrate. Close the lid and remove paper from the document feeder.	91
Unexpected size in tray # Load <size> Press [OK]	92
Tools for troubleshooting: Event-log messages	92
Print the event log	92
Event log messages	92
Clear jams	95
Jam locations	95
Experiencing frequent or recurring paper jams?	95
Clear jams in the document feeder	97
Clear jams in Tray 1	98
Clear jams in Tray 2	100
Clear jams in Tray 3 (accessory)	101
Clear jams in the duplexer	103
Clear jams in the output bin	105
Paper feeds incorrectly or becomes jammed	106
The product does not pick up paper	106
The product picks up multiple sheets of paper	106
Solve image-quality problems	107
Solve image quality problems: Image defects table	107
Improve print quality	112
Print from a different software program	113
Check the paper-type setting for the print job	113
Check the paper type setting (Windows)	113
Check the paper type setting (Mac OS X)	113
Check toner-cartridge status	113
Print and interpret the print quality page	114

Clean the product	115
Print a cleaning page	115
Check the scanner glass for dirt and smudges	115
Visually inspect the toner cartridge	116
Check paper and the printing environment	116
Step one: Use paper that meets HP specifications	116
Step two: Check the environment	116
Calibrate the product to align the colors	117
Check other print job settings	117
Check the EconoMode settings	117
Adjust color settings (Windows)	118
Try a different print driver	119
General print-quality issues	120
Solve paper-handling problems	125
Product feeds incorrect page size	125
Product pulls from incorrect tray	125
Paper does not feed automatically	125
Paper does not feed from Tray 2 or 3	126
Output is curled or wrinkled	126
Product will not duplex or duplexes incorrectly	127
Clean the product	128
Clean the pickup and separation rollers	128
Clean the paper path	128
Clean the scanner glass strip and platen	128
Clean the document feeder pickup rollers and separation pad	129
Clean the touchscreen	130
Solve performance problems	131
Factors affecting print performance	131
Print speeds	131
The product does not print or it prints slowly	132
The product does not print	132
The product prints slowly	133
Solve connectivity problems	134
Solve USB connection problems	134
Solve wired network problems	134
Poor physical connection	134
The computer is using the incorrect IP address for the product	134
The computer is unable to communicate with the product	135
The product is using incorrect link and duplex settings for the network	135
New software programs might be causing compatibility problems	135
The computer or workstation might be set up incorrectly	135

The product is disabled, or other network settings are incorrect	135
Solve wireless network problems	135
Wireless connectivity checklist	136
The product does not print after the wireless configuration completes	136
The product does not print, and the computer has a third-party firewall installed ...	137
The wireless connection does not work after moving the wireless router or product	137
Cannot connect more computers to the wireless product	137
The wireless product loses communication when connected to a VPN	137
The network does not appear in the wireless networks list	137
The wireless network is not functioning	137
Perform a wireless network diagnostic test	138
Reduce interference on a wireless network	138
Solve fax problems	139
Checklist for solving fax problems	139
Perform a fax diagnostic test	140
Solve general fax problems	140
Faxes are sending slowly	140
Fax quality is poor	141
Fax cuts off or prints on two pages	142
Solve problems receiving faxes	142
The fax does not respond	143
The fax has a dedicated phone line	143
An answering machine is connected to the product	143
The Answer Mode setting is set to the Manual setting	144
Voice mail is available on the fax line	144
The product is connected to a DSL phone service	144
The product uses a fax over IP or VoIP phone service	144
An error message displays on the control panel	145
The No Fax Detected message displays	145
The Communication Error message appears	145
The Fax storage is full. message appears	146
The Fax is busy. message appears	146
A fax is received but does not print	147
The Private Receive feature is on	147
Sender receives a busy signal	147
A handset is connected to the product	147
A phone line splitter is being used	147
No dial tone	147
Cannot send or receive a fax on a PBX line	147
Solve problems sending faxes	147

An error message displays on the control panel	148
The Communication Error message appears	148
No dial tone.	149
The Fax is busy. message appears	149
The No fax answer. message appears	149
Document feeder paper jam	150
The Fax storage is full. message appears	150
Scanner error	150
The control panel displays a Ready message with no attempt to send the fax	150
The control panel displays the message "Storing page 1" and does not progress beyond that message	151
Faxes can be received, but not sent	151
Product is password protected	151
Unable to use fax functions from the control panel	152
Unable to use speed dials	152
Unable to use group dials	152
Receive a recorded error message from the phone company when trying to send a fax	152
Unable to send a fax when a phone is connected to the product	153
Fax trace report	154
Fax error report printing	154
Print all fax reports	154
Print individual fax reports	154
Set the fax error report	155
Set the fax-error-correction mode	155
Change the fax speed	155
Solve email problems	156
Cannot connect to the email server	156
The email failed	156
Unable to scan	156
Validate LDAP gateway	157
Access control for LaserJet Pro devices	157
Product resets	158
Restore the factory-set defaults	158
NVRAM initialization	158
Super NVRAM initialization	158
Firmware upgrades	159
Appendix A Product specifications	161
Product dimensions	162
Power consumption, electrical specifications, and acoustic emissions	162

Environmental specifications 162
Certificate of Volatility 163

Index 165

List of tables

Table 1-1	Sequence of operation	3
Table 2-1	Basic problem solving	40
Table 2-2	Major components	50
Table 2-3	Solenoid, sensors, and motors	52
Table 2-4	Rollers	53
Table 2-5	PCAs	54
Table 2-6	Optional 250-sheet cassette	55
Table 2-7	Repetitive defects	64
Table 2-8	HP Web Services menu	65
Table 2-9	Reports menu	66
Table 2-10	Self Diagnostics menu	66
Table 2-11	Fax Setup menu	67
Table 2-12	System Setup menu	69
Table 2-13	Service menu	72
Table 2-14	Network Setup menu	74
Table 2-15	Quick Forms Menu	75
Table 2-16	Fax Menu	75
Table 2-17	Copy Menu	77
Table 2-18	Event-log messages	92
Table 2-19	Event-log-only messages	94
Table 2-20	Image defects table	107
Table 2-21	General print-quality issues	120
Table 2-22	Factors affecting print performance	131
Table A-1	Physical specifications	162
Table A-2	Operating-environment specifications	162

List of figures

Figure 1-1	Product components	2
Figure 1-2	Engine control system components	7
Figure 1-3	DC controller circuit diagram	8
Figure 1-4	Low-voltage power supply	9
Figure 1-5	Fuser block diagram	10
Figure 1-6	Fuser control circuit	11
Figure 1-7	High-voltage power supply	14
Figure 1-8	Laser/scanner system	15
Figure 1-9	Image-formation system	16
Figure 1-10	Image-formation process	17
Figure 1-11	Primary charging	17
Figure 1-12	Laser-beam exposure	18
Figure 1-13	Development	18
Figure 1-14	Primary transfer	19
Figure 1-15	Secondary transfer	19
Figure 1-16	Separation from the drum	20
Figure 1-17	Fusing	20
Figure 1-18	ITB cleaning	21
Figure 1-19	Drum cleaning	22
Figure 1-20	Pickup-and-feed system	23
Figure 1-21	Multiple-feed prevention	26
Figure 1-22	ADF paper path	31
Figure 1-23	ADF jam clearance	32
Figure 2-1	Control-panel 2ndary Service test access buttons	45
Figure 2-2	Engine test button access	47
Figure 2-3	Major components	50
Figure 2-4	Motors and fans	52
Figure 2-5	Rollers	53
Figure 2-6	PCAs	54
Figure 2-7	Optional 250-sheet cassette	55
Figure 2-8	Timing diagram	56
Figure 2-9	Circuit diagram	57

Figure 2-10	CPU diagram	58
Figure 2-11	ASIC diagram	59
Figure 2-12	HVT/Toner EMP diagram	60
Figure 2-13	Driver PCA diagram	61
Figure 2-14	Duplexer PCA diagram	62
Figure 2-15	FSR diagram	63
Figure A-1	Certificate of Volatility (1 of 2)	163
Figure A-2	Certificate of Volatility (2 of 2)	164

1 Theory of operation

This chapter presents an overview of the major components of the product, and includes a detailed discussion of the image-formation system.

- [Basic operation](#)
- [Formatter-control system](#)
- [Engine control system](#)
- [Laser/scanner system](#)
- [Image-formation system](#)
- [Pickup-and-feed system](#)
- [Scanning and image capture system](#)
- [ADF operation](#)
- [Fax functions and operation](#)
- [USB flash drive](#)

Basic operation

Major systems

The product includes the following systems:

- Engine control system
- Laser/scanner system
- Image-formation system
- Pickup-and-feed system
- Document feeder system

Product components

Figure 1-1 Product components

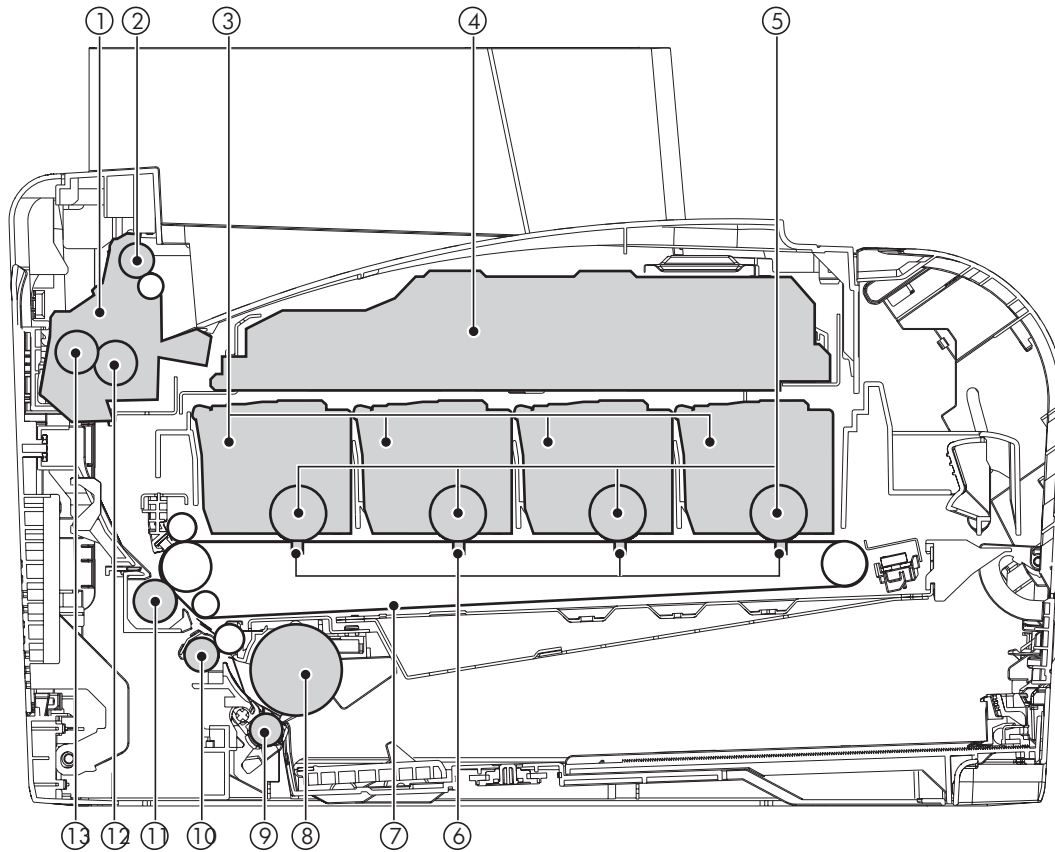

Item	Description	Item	Description
1	Fuser unit	8	Pickup roller
2	Delivery roller	9	Separation roller
3	Print cartridge	10	Registration roller
4	Laser/scanner unit	11	Secondary transfer roller
5	Photosensitive drum	12	Fusing film

Item	Description	Item	Description
6	Primary transfer pad	13	Pressure roller
7	Intermediate transfer belt (ITB)		

Sequence of operation

Table 1-1 Sequence of operation

Period	Duration	Purpose	Remarks
WAIT	From the time the power is turned on or the door is closed until the drum-phase adjustment is complete	Clears the potential from the drum surface, adjusts the drum phase, and cleans the ETB	Detects the toner level, cartridge presence, and environment; completes any required calibration (color registration control and image stability)
STBY (Standby period)	From end of the WAIT or LSTR period until either the print command is received from the formatter or the power is turned off	Maintains the product in readiness for a print command	The product enters sleep mode when the formatter sends a sleep command, and performs color registration and the image stability control when the formatter sends those commands
INTR (Initial rotation)	From the time the print command is received until the media is picked up	Prepares the photosensitive drum for printing	
PRINT	From the end of INTR period until the fuser paper sensor detects the trailing edge of paper	Forms the images on the photosensitive drum and transfers the toner image to the print media	Performs image stabilization at a specified print interval or at specified times
LSTR (Last rotation)	From the end of the PRINT period until the delivery motor stops rotating	Moves the printed sheet out of the product	The product enters the INTR period as soon as the formatter sends another print command

Formatter-control system

The formatter is involved in the following procedures.

- Controlling the [Sleep Delay](#) function
- Receiving and processing print data from the various product inputs
- Monitoring control-panel functions and relaying product status information (through the control panel and the bidirectional input/output)
- Developing and coordinating data placement and timing with the DC controller PCA
- Storing font information
- Communicating with the host computer through the bidirectional interface

The formatter receives a print job from the bidirectional interface and separates it into image information and instructions that control the printing process. The dc controller PCA synchronizes the image-formation system with the paper-input and -output systems, and then signals the formatter to send the print-image data.

Sleep Delay

When the product is in [Sleep Delay](#), the control-panel backlight is turned off, but the product retains all product settings, downloaded fonts, and macros. The default setting is a 15-minute idle time. [Sleep Delay](#) can be turned off from the [System Setup](#) menu on the control panel.

The product exits [Sleep Delay](#) and enters the warm-up cycle when any of the following occurs.

- A print job, valid data, or a PML or PJJL command is received at the serial port.
- The control panel is touched.
- A document is loaded in the document feeder or the scanner lid is opened.
- A tray is opened.
- The engine-test button is pressed.



TIP: Error messages override the [Sleep Delay](#) message. The product enters Sleep mode at the appropriate time, but the error message continues to appear.

Input/output

The following sections discuss the input and output features of the product.

USB

The product includes a universal serial bus (USB) 2.0 connection.

10/100 networking

The product includes a 10/100 network connection.

Fax

The product includes a fax phone line connection.

USB hosts

The product includes USB hosts for USB flash drive and wireless communication control.

Memory

If the product encounters a problem when managing available memory, a clearable warning message appears on the control panel.

Flash memory

NOR: Stores microprocessor control programs and internal character sets (fonts).

NAND: Stores fax memory and driver installation software.

Random access memory

All models come with 192 MB of memory installed. The formatter has 256MB NAND Flash.

Nonvolatile memory

The product uses nonvolatile memory (NVRAM) to store I/O and information about the print environment configuration. The contents of NVRAM are retained when the product is turned off or disconnected.

Memory Enhancement technology

The HP Memory Enhancement technology (MEt) effectively doubles the standard memory through a variety of font- and data-compression methods.



NOTE: The MEt is available only in PCL mode; it is not functional when printing in PS mode.

Wireless radio

Wireless products contain a wireless card to enable 802.11b/g/n wireless communication.

PJL overview

Printer job language (PJL) is an integral part of configuration, in addition to the standard printer command language (PCL). With standard cabling, use PJL to perform a variety of functions.

- Dynamic I/O switching. The product can be configured with a host on each I/O by using dynamic I/O switching. Even when the product is offline, it can receive data from more than one I/O simultaneously, until the I/O buffer is full.
- Context-sensitive switching. The product can automatically recognize the personality (PS or PCL) of each job and configure itself in that personality.
- Isolation of print environment settings from one print job to the next. For example, if a print job is sent to the product in landscape mode, the subsequent print jobs are printed in landscape mode only if they are formatted for it.

LEDm overview

The low-end data model (LEDm) provides one consistent data representation method and defines the dynamic and capabilities tickets shared between clients and devices, as well as the access protocol, event, security, and discovery methods.

ACL overview

The advanced control language (ACL) is a language that supports product control and firmware downloads in printers that support both PjL/PCL and host-based printing. Each sequence of ACL commands must be preceded by a unified exit command (UEL) and an @PjL ENTER LANGUAGE=ACL command. The ACL sequence is always followed by a UEL. Any number of commands can be placed between the UELs. The only exception to these rules is the download command. If a firmware download is done, the download command must be the last command in the sequence. It will not be followed by a UEL.

The firmware searches for the UEL sequence when parsing commands. However, while downloading binary data such as host-based code or NVRAM data the firmware suspends UEL parsing. To handle hosts that “disappear” during binary sequences, the firmware times out all ACL command sessions. If a timeout occurs during a non-download command sequence, it is treated as the receipt of a UEL. If a timeout occurs during firmware download the product resets.

PML

The printer management language (PML) allows remote configuration and status monitoring through the I/O ports.

Control panel

The formatter sends and receives product status and command data to and from a touch-screen control panel.

NFC

(Wireless bundles only) This product supports near field communication (NFC) capabilities. NFC enables an easy one-to-one HP wireless direct print connection using a simple device-to-device touch. Mobile device users can quickly connect to the printer and print documents and images from a mobile device, such as a smartphone or tablet, by touching the device to the NFC icon on the bottom of the control panel.

Engine control system

The engine control system coordinates all product functions and drives the other three systems.

The engine control system contains the DC controller, high-voltage power supply PCA, and low-voltage power supply/fuser power supply unit.

Figure 1-2 Engine control system components

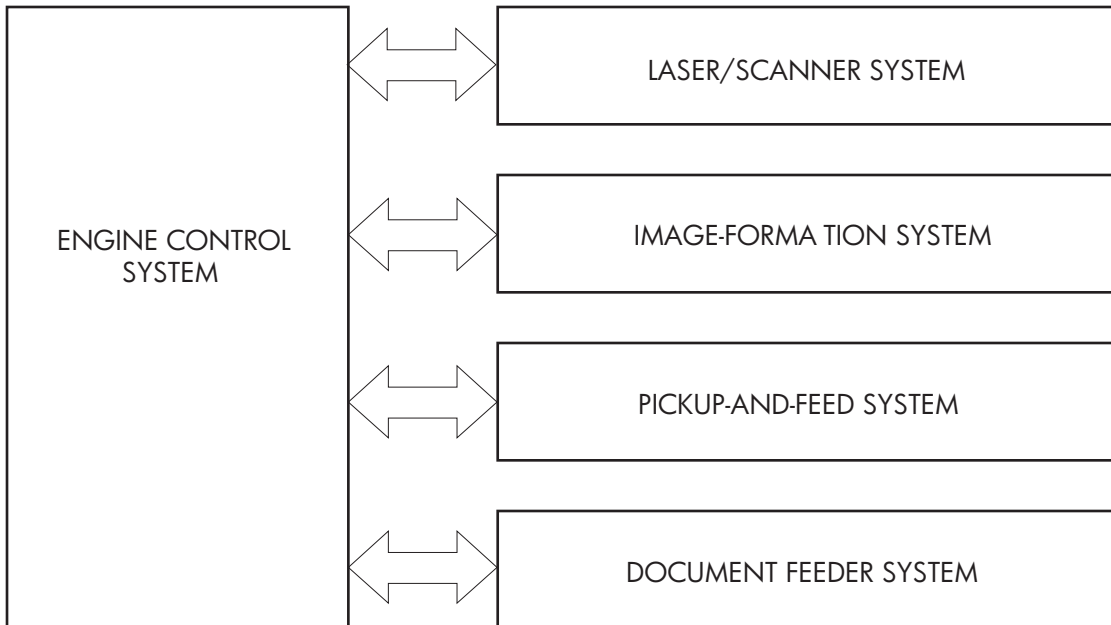

DC controller

The DC controller PCA controls the operation of the product and its components. The DC controller PCA starts product operation when the power is turned on and the power supply sends DC voltage to the DC controller PCA. After the product enters the standby sequence, the DC controller PCA sends out various signals to operate motors, solenoids, and other components based on the print command and image data that the host computer sends.

Figure 1-3 DC controller circuit diagram

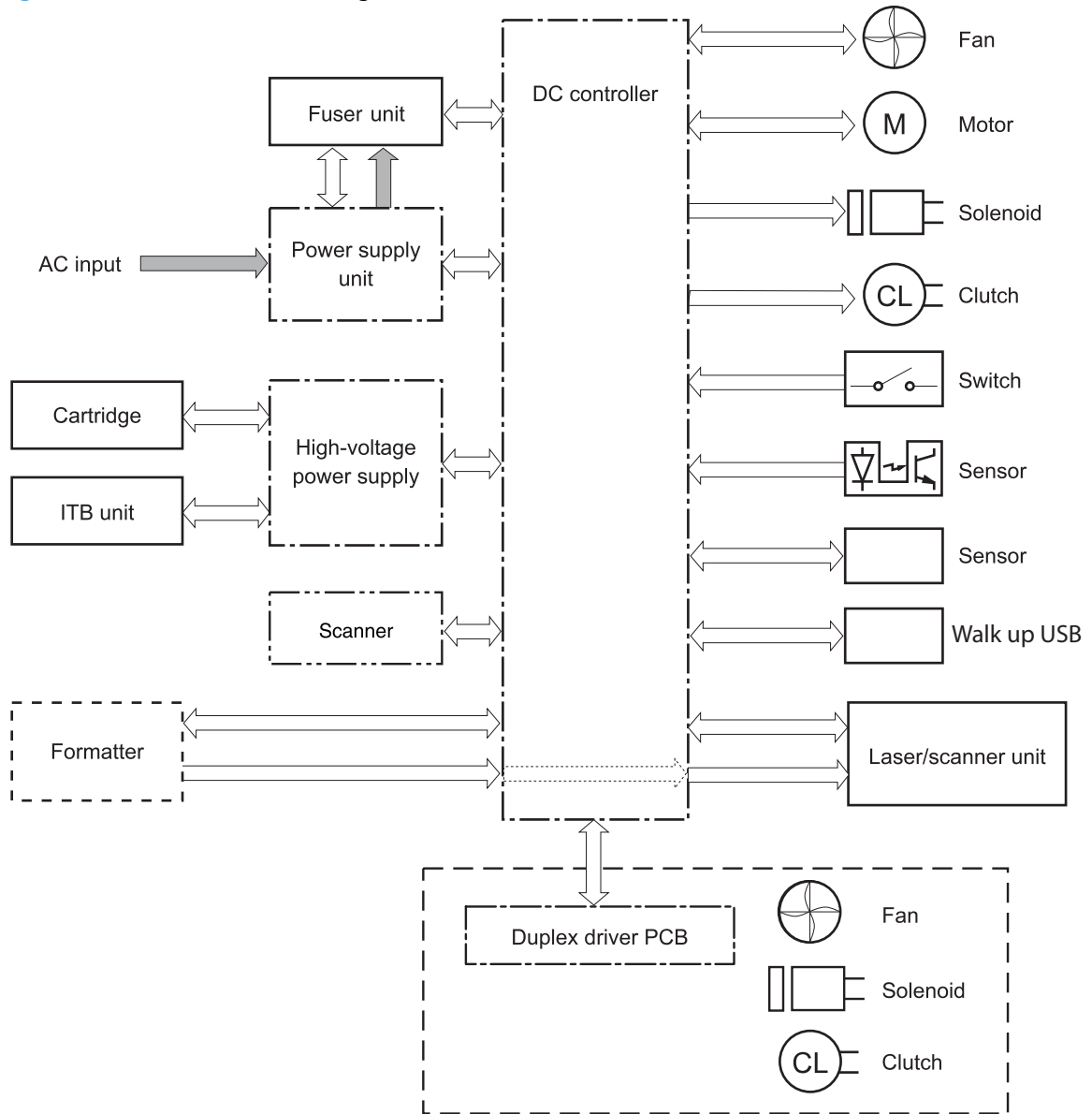

Power supply

The low-voltage power supply and the fuser power supply convert AC power from the power receptacle into DC power to cover the DC loads.

Figure 1-4 Low-voltage power supply

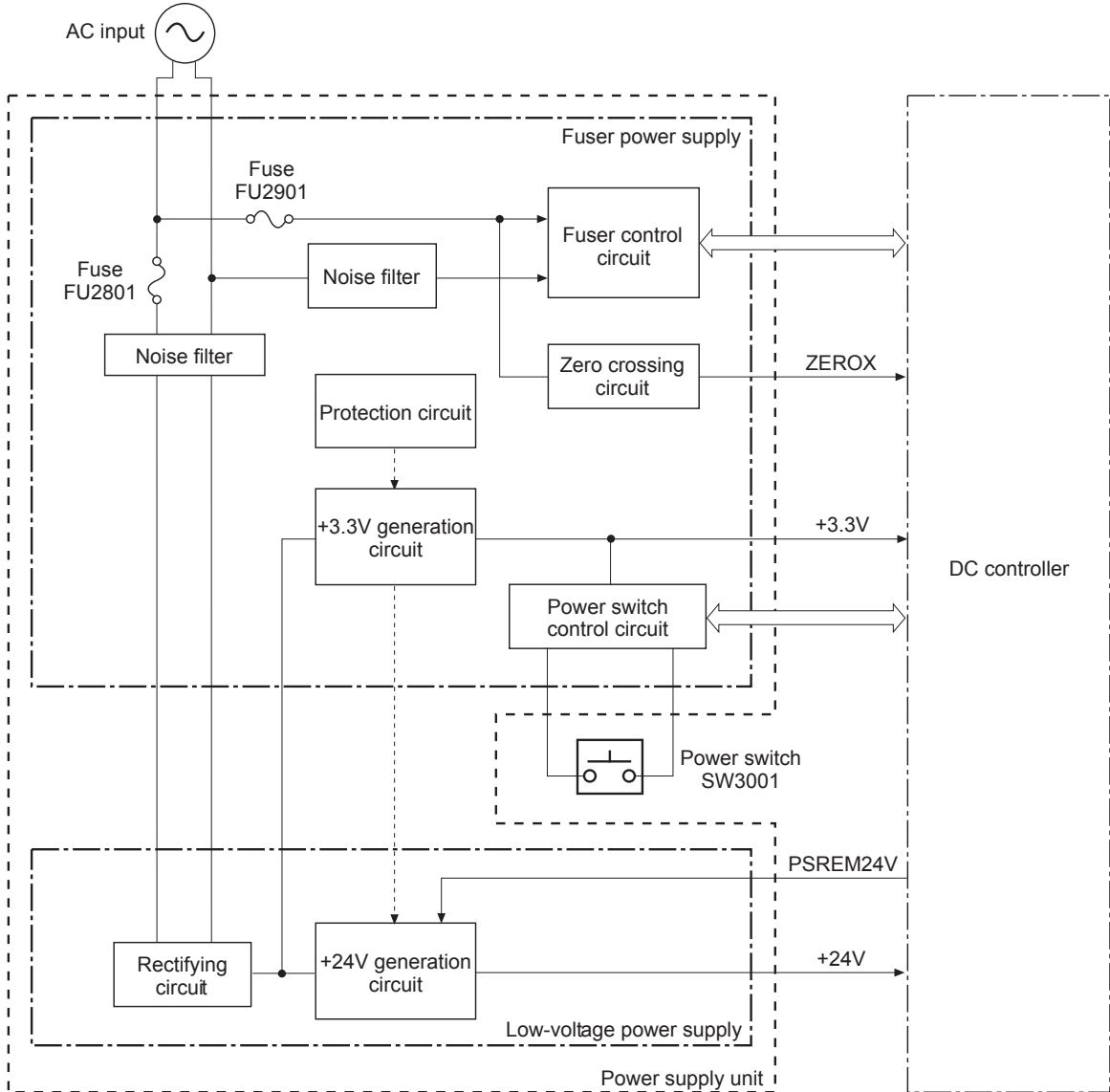

Protective function

The power supply unit has a protective function against overcurrent and overvoltage to prevent failures in the power supply circuit. If an overcurrent or overvoltage instance occurs, the system automatically cuts off the output voltage.

If the DC voltage is not being supplied from the power supply unit, the protective function might be running. If that is the case, turn off the power switch and unplug the power cord. Do not plug in the power cord and do not turn the power switch on again until the root cause is found.

In addition, a fuse protects against overcurrent instances. If an overcurrent instance flows into the AC line, the fuse deactivates and cuts off the power distribution.

Power saving

The **Sleep Delay** feature reduces power consumption when the product has been inactive for an extended period. You can set the length of time before the product enters sleep mode. See [Sleep Delay on page 4](#).

The **Auto Power Down** feature turns the product off after a certain length of time. You can adjust this time setting.

Fuser control

The power supply unit controls the temperature in the fuser unit. The product uses an on-demand fusing method.

Figure 1-5 Fuser block diagram

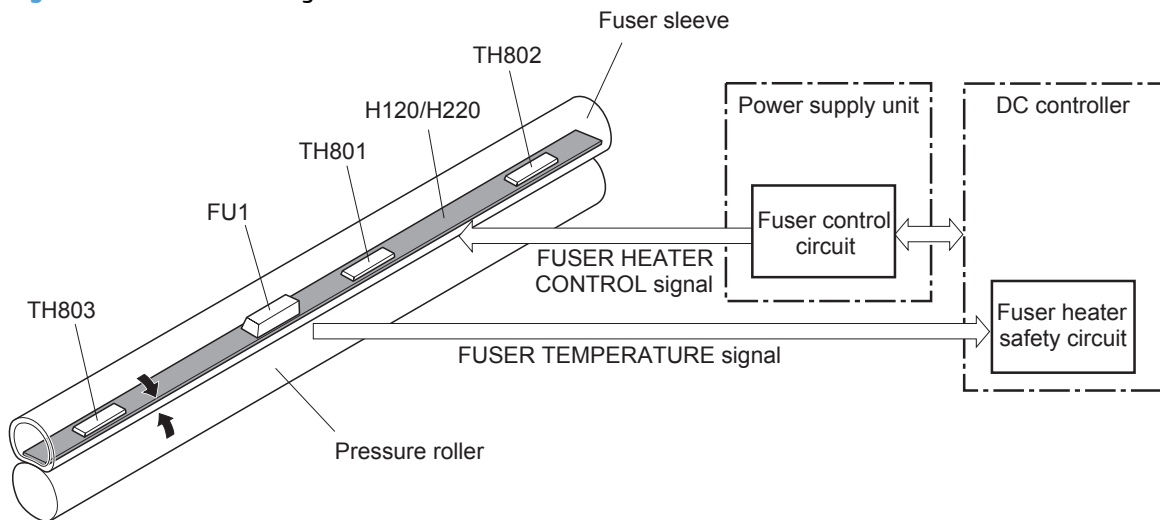

The fuser is composed of the following components.

- Heater (100V model: H120—200V model: H220): Heats the fuser sleeve
- Thermistors
 - Main thermistor (TH801): Detects the center temperature of the fuser heater (contact type)
 - Sub thermistor 1 (TH802): Detects the right side temperature of the fuser heater (contact type)
 - Sub thermistor 2 (TH803): Detects the left side temperature of the fuser heater (contact type)
- Thermal fuse (FU1): Prevents an abnormal temperature rise of the fuser heater

These fuser temperature controls are performed by the fuser control circuit and the fuser heater safety circuit, which receive commands from the DC controller.

Fuser control circuit

The fuser control circuit maintains the temperature of the fuser heater at its targeted temperature.

The DC controller monitors the fuser temperature (MAINTH, SUBTH and SUB2TH) signals and sends the fuser heater control (FSRD) signal according to the detected temperature. The fuser heater control circuit controls the fuser heater depending on the signal so that the heater remains at the targeted temperature.

Figure 1-6 Fuser control circuit

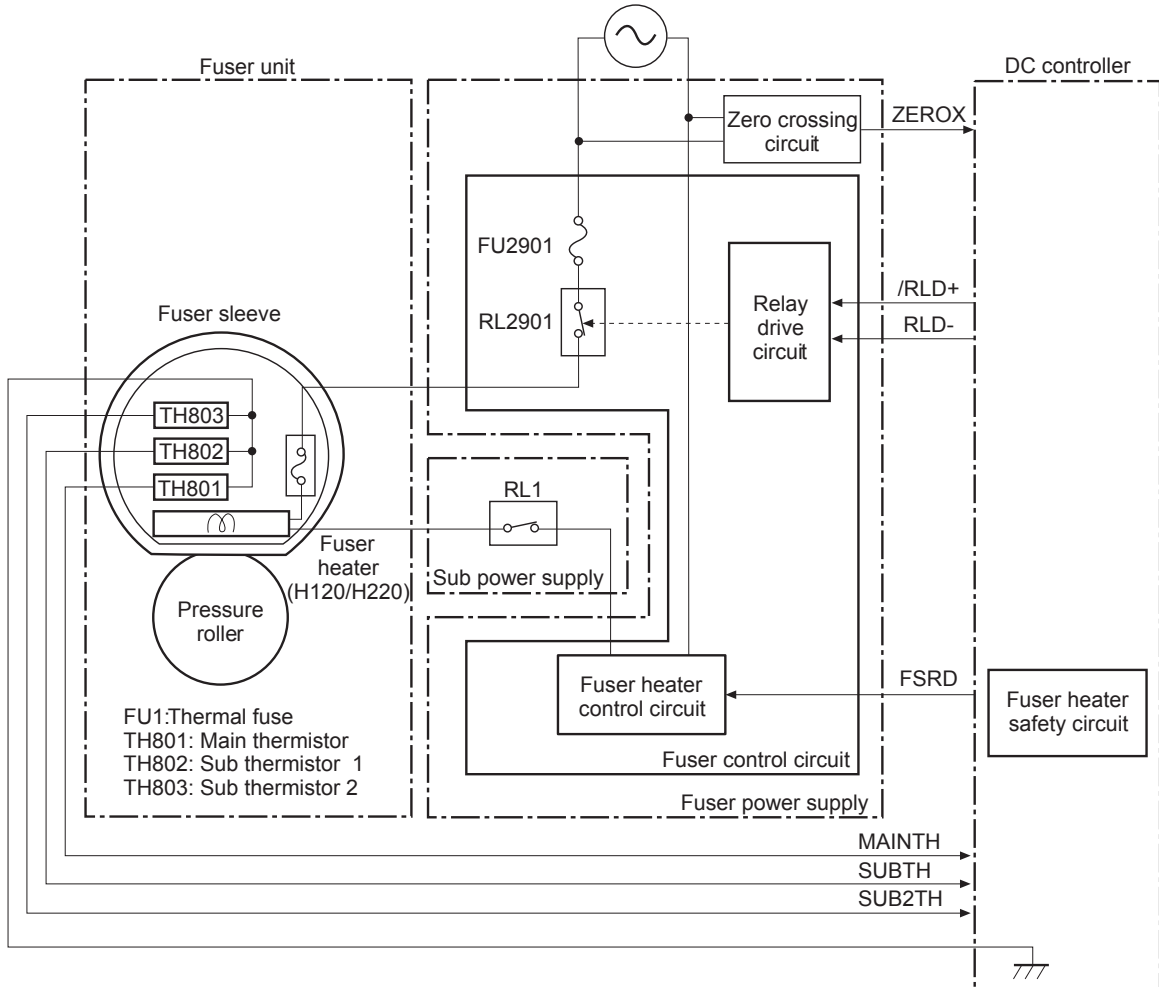

Fuser protective function

The protective function detects an abnormal temperature rise of the fuser and interrupts power supply to the fuser heater. The following protective components prevent an abnormal temperature rise of the fuser heater.

- DC controller

The DC controller monitors the detected temperature of the thermistors. It deactivates the fuser heater control signal and releases the relay to interrupt the power supply to the fuser heater under the following conditions.

- Main thermistor: 253°C (487.4°F) or higher
- Sub thermistor 1: 273°C (523.4°F) or higher
- Sub thermistor 2: 273°C (523.4°F) or higher

- Fuser heater safety circuit

The fuser heater safety circuit monitors the detected temperature of the thermistors. It releases the relay to interrupt the power supply to the fuser heater under the following conditions.

- Main thermistor: 320°C (608°F) or higher
- Sub thermistor 1: 295°C (563°F) or higher
- Sub thermistor 2: 295°C (563°F) or higher

- Thermal fuse

The thermal fuse blows to interrupt power supply to the fuser heater if the thermal fuse temperature reaches 228°C (442°F) or higher.

Fuser failure detection

The DC controller determines a fuser unit failure, deactivates the fuser heater control signal, releases the relay to interrupt power supply to the fuser heater, and then notifies the formatter of a failure state when it encounters the following conditions.

- Start-up failure conditions
 - The main thermistor temperature does not reach 50°C (122°F) within a specified period of heater startup during the wait period.
 - The main thermistor temperature does not reach the targeted temperature within a specified period after the temperature once reaches 50°C (122°F) from the heater startup during the wait period.
 - The main thermistor temperature does not reach the targeted temperature within a specified period under the heater temperature control during the initial rotation period.
- Abnormal low temperature conditions
 - The main thermistor temperature remains at 100°C (212°F) or lower for a specified period under the heater temperature control during the print period.
- Abnormal high temperature conditions
 - The main thermistor temperature remains at 235°C (487°F) or higher for a specified period.
 - The temperature of either one of the sub thermistors remains at 273°C (523°F) or higher for a specified period.
- Fuser heater drive circuit failure
 - The specified count of the zero crossing signal is not detected within a specified period after the product is turned on.
 - The frequency is out of the specified range (40 to 70 Hz).

High-voltage power supply

The DC controller controls the high-voltage power supply to generate high-voltage biases. The high-voltage power supply generates the high-voltage biases that are applied to the primary charging roller, developing roller, primary transfer pad, secondary transfer roller, and ITB cleaning unit.

Figure 1-7 High-voltage power supply

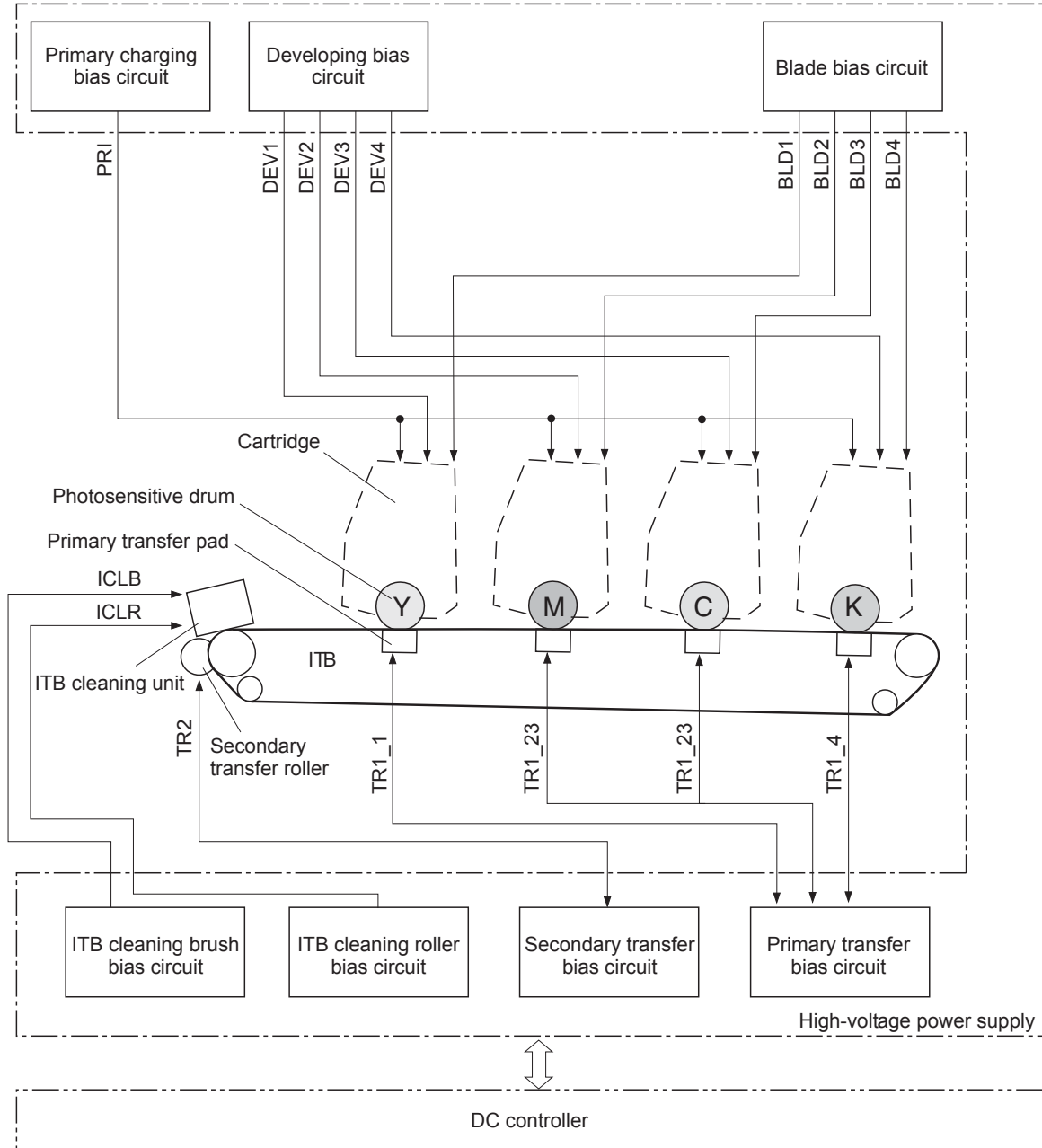

Laser/scanner system

The formatter sends video signals to the DC controller, which controls the laser/scanner. When the laser/scanner system receives those signals, it converts them to latent images on the photosensitive drum.

Figure 1-8 Laser/scanner system

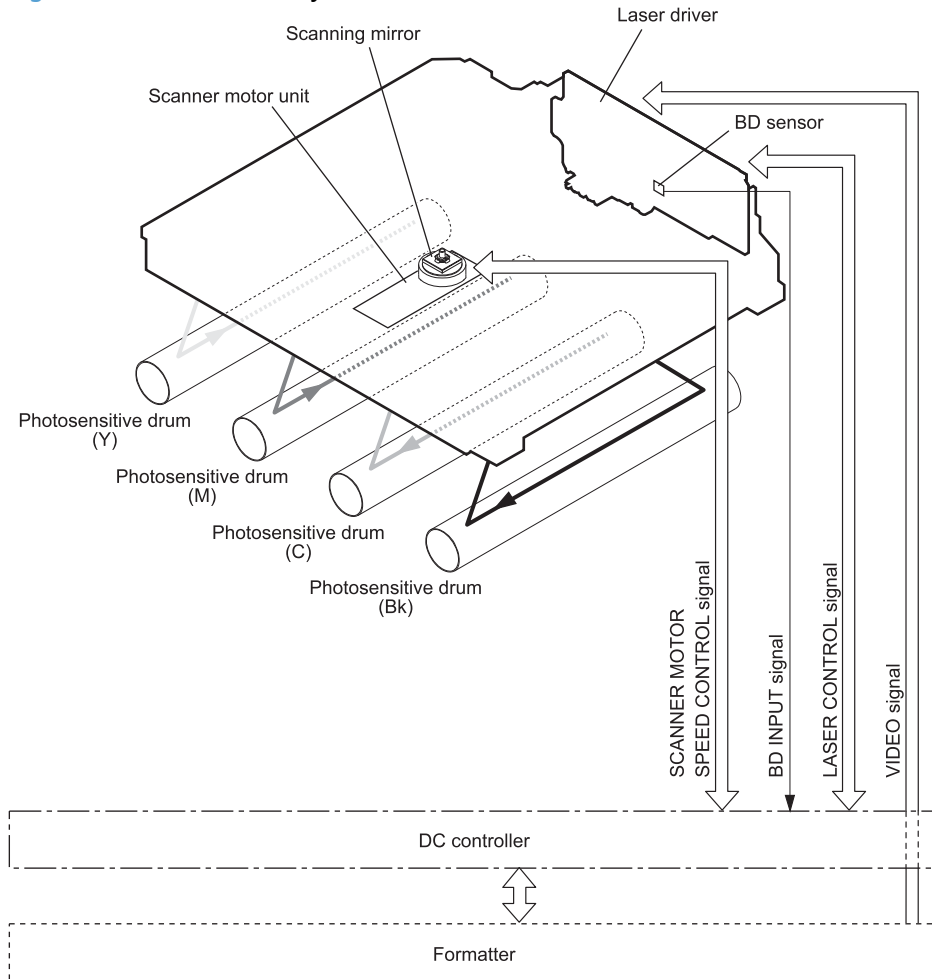

Laser failure detection

The optical unit failure detection sensor manages the laser/scanner unit failure-detection functions. The DC controller identifies the laser/scanner unit failure and notifies the formatter if the laser/scanner unit encounters the following conditions:

- Scanner motor failure
- BD failure

Image-formation system

The image-formation system forms a toner image on media. The product includes four print cartridges that contain the toner that is used to create the image on the media. Toner is applied in the following order, using only the colors necessary for a specific image: yellow (Y), magenta (M), cyan (C), and black (Bk).

Figure 1-9 Image-formation system

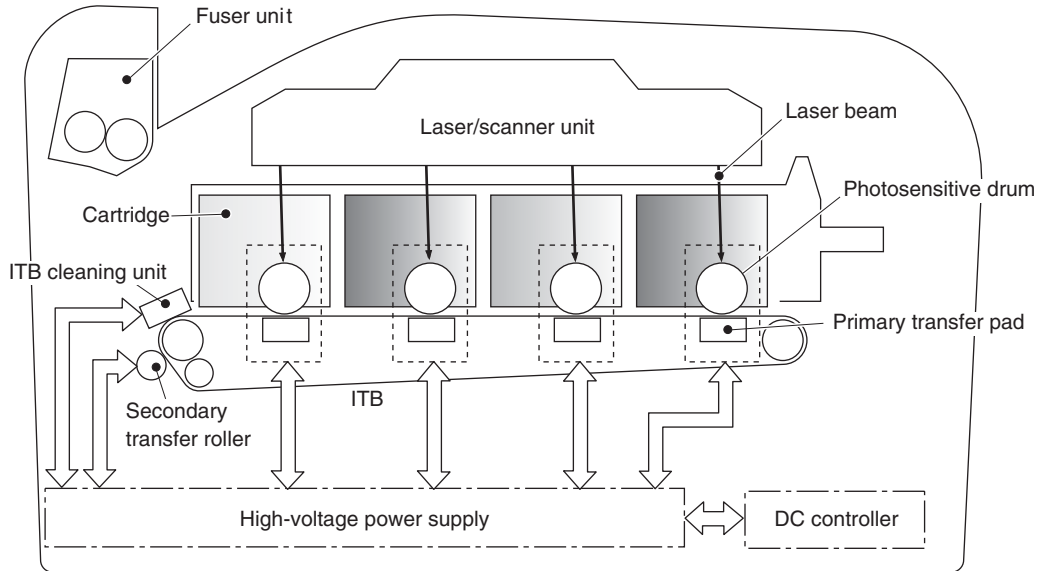

Image-formation process

Overview

Laser printing requires the interaction of several different technologies including electronics, optics, and electrographics to provide a printed page. Each process functions independently and must be coordinated with the other processes. Image formation consists of the following processes:

These processes are divided into nine steps and described in the following sections.

- Latent-image formation
 - Primary charging
 - Laser beam exposure
- Development
- Transfer
 - Primary transfer
 - Secondary transfer
 - Separation
- Fuser

- ITB cleaning
- Drum cleaning

Figure 1-10 Image-formation process

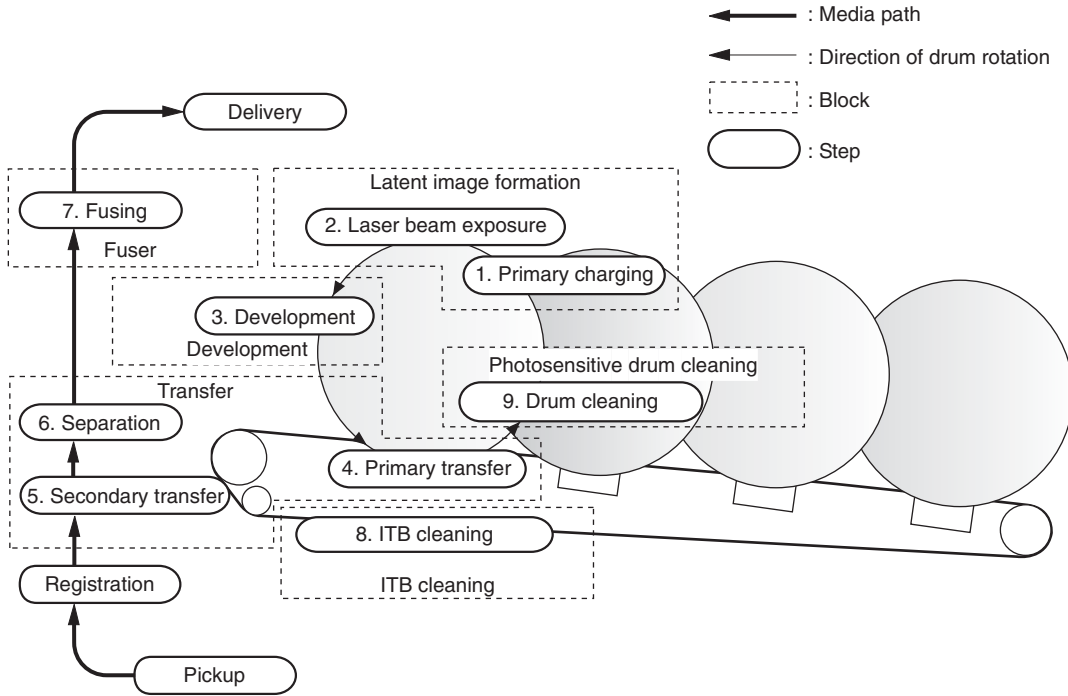

Latent-image formation stage

During the steps that comprise this stage, a latent image is formed by applying a negative charge to the photosensitive drum. You cannot see this image on the drum.

Step 1: primary charging

A high-voltage DC bias is applied to the primary charging roller, which is made of conductive rubber and is in contact with the drum surface. As the roller moves across the drum, it applies the negative charge to that surface.

Figure 1-11 Primary charging
Primary charging roller

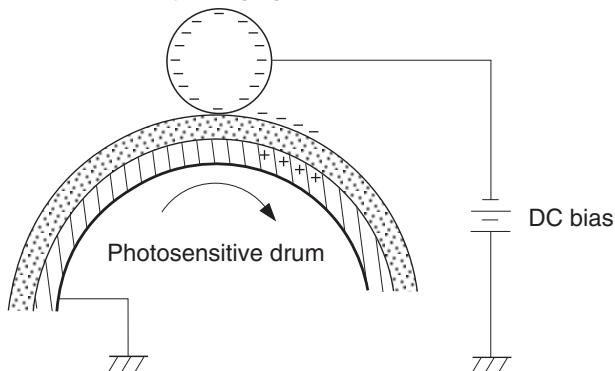

Step 2: laser-beam exposure

The laser beam scans the photosensitive drum to neutralize the negative charge on portions of the drum surface. An electrostatic latent image is formed where the negative charge was neutralized.

Figure 1-12 Laser-beam exposure

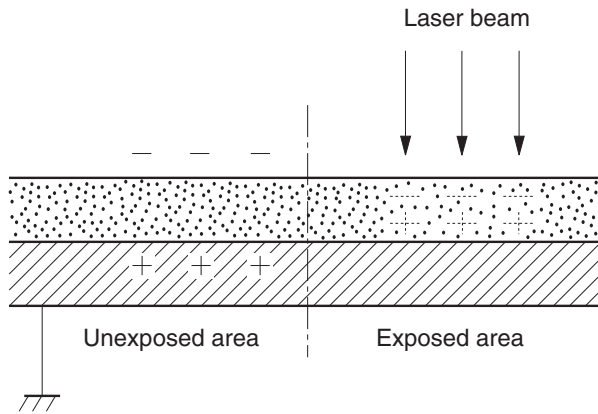

Developing stage

The developing cylinder comes in contact with the photosensitive drum and deposits toner on the electrostatic latent image.

Step 3: development

Toner acquires a negative charge as a result of the friction from the developing cylinder rotating against the developing blade. When the negatively charged toner comes in contact with the drum, it adheres to the electrostatic latent image. When the toner is on the drum, the image becomes visible.

Figure 1-13 Development

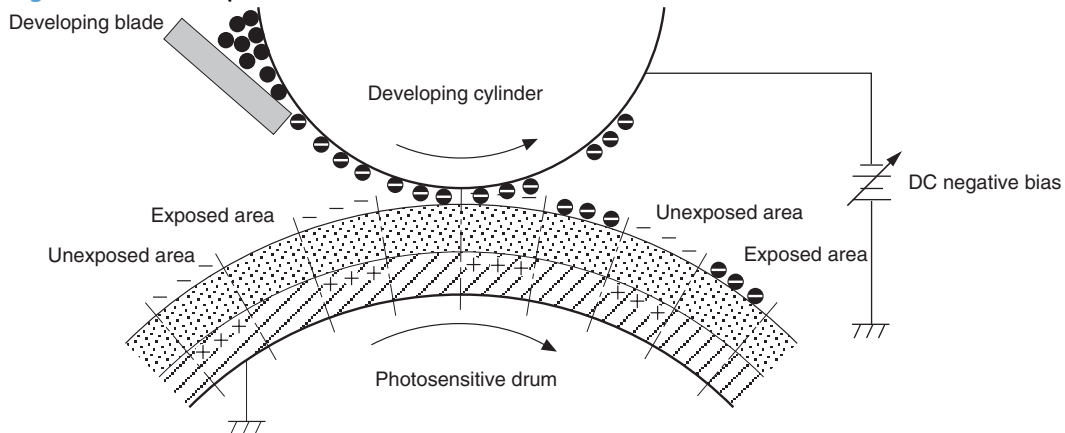

Transfer stage

Step 4: primary transfer

The toner image on the photosensitive drum is transferred to the ITB. The DC positive bias is applied to the primary transfer pad. The negatively charged toner transfers to the ITB from the drum surface.

Figure 1-14 Primary transfer

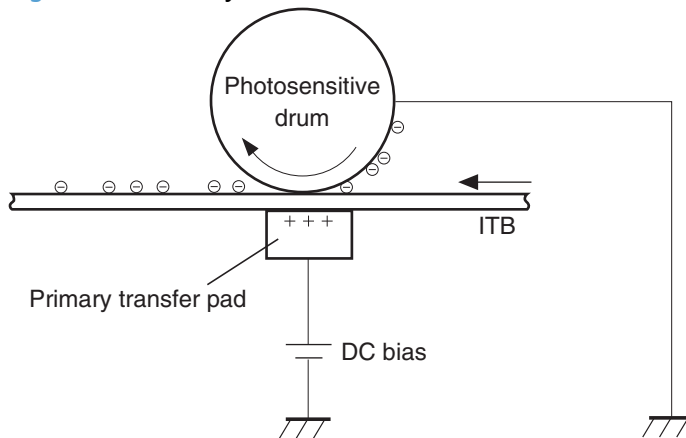

Step 5: secondary transfer

The toner image on the ITB is transferred to the print media. The DC positive bias is applied to the secondary transfer roller. As the media passes between the secondary transfer roller and the ITB, the toner image is transferred to the media.

Figure 1-15 Secondary transfer

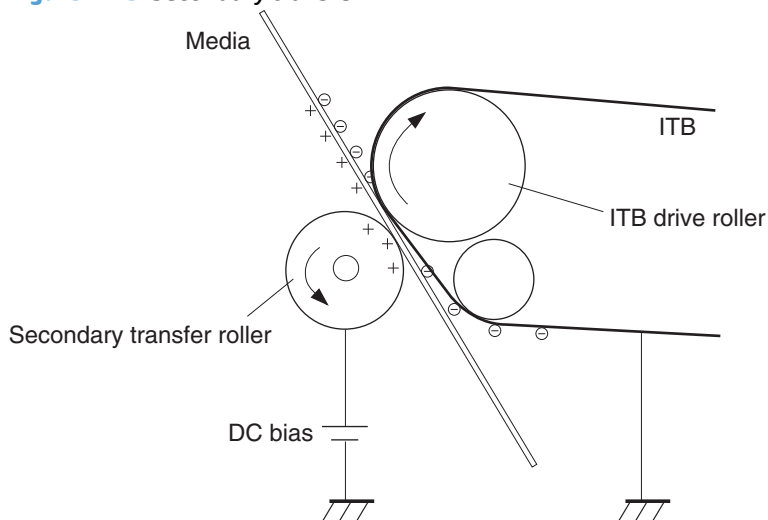

Step 6: separation from the drum

The elasticity of the print media and the curvature of the ITB drive roller cause the media to separate from the ITB.

Figure 1-16 Separation from the drum

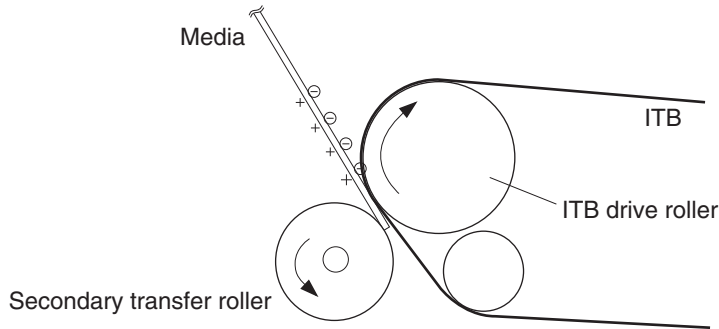

Fusing stage

Until the fusing stage is complete, the image is not permanently affixed to the print media. The toner can be easily smudged until the heat and pressure of the fusing process fix the image to the sheet.

Step 7: fusing

The product uses an on-demand fusing method to fuse the toner image onto the media. The toner image is permanently affixed to the print media by the heat and pressure.

Figure 1-17 Fusing

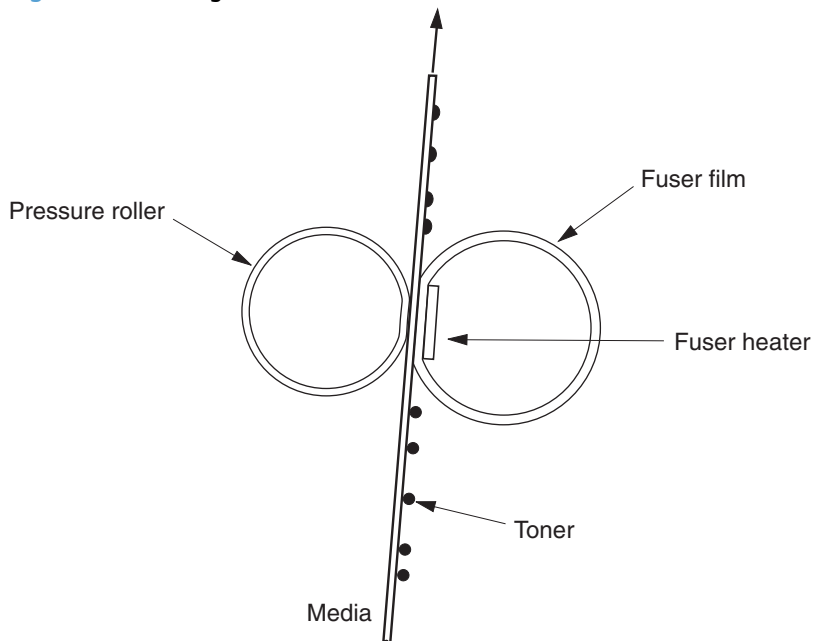

ITB cleaning stage

Step 8: ITB cleaning

The ITB cleaning roller and the cleaning brush are applied with DC positive bias to charge the residual toner positive. Because the primary transfer pad is also applied with DC positive bias, the positively charged residual toner is reverse-transferred to the photosensitive drum from the ITB surface.

Figure 1-18 ITB cleaning

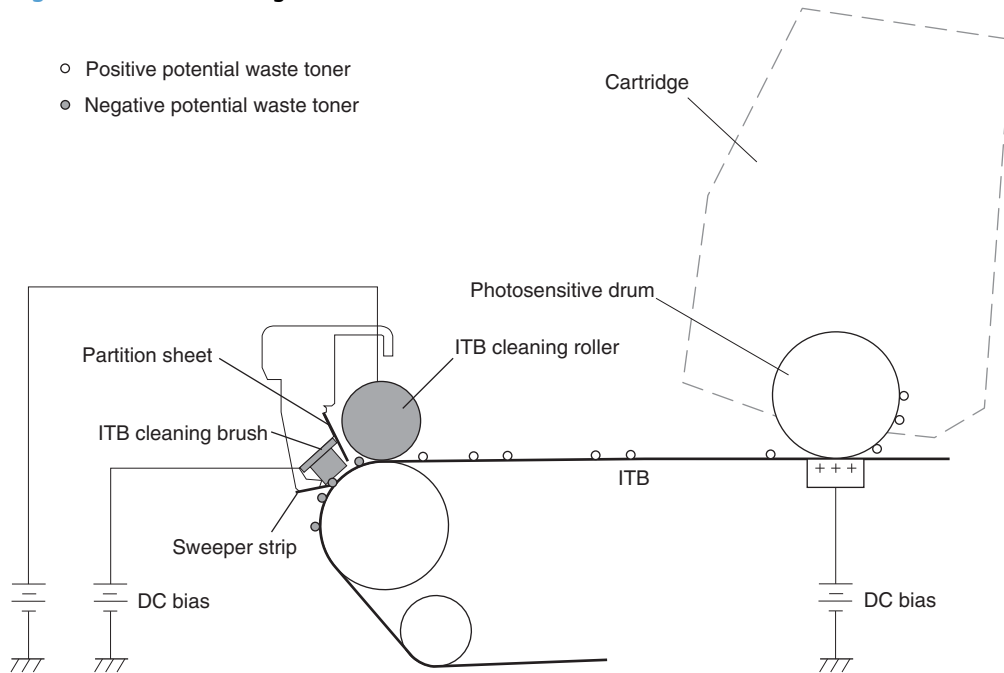

Drum cleaning stage

Not all of the toner is removed from the photosensitive drum during the transfer stage. During the cleaning stage, the residual, or waste, toner is cleared from the drum surface to prepare the surface for the next latent-image formation.

Step 9: drum cleaning

The cleaning blade scrapes the residual toner off the surface of the photosensitive drum and deposits it in the waste-toner container. The drum is now clear, and is ready for the next image-formation process.

Figure 1-19 Drum cleaning

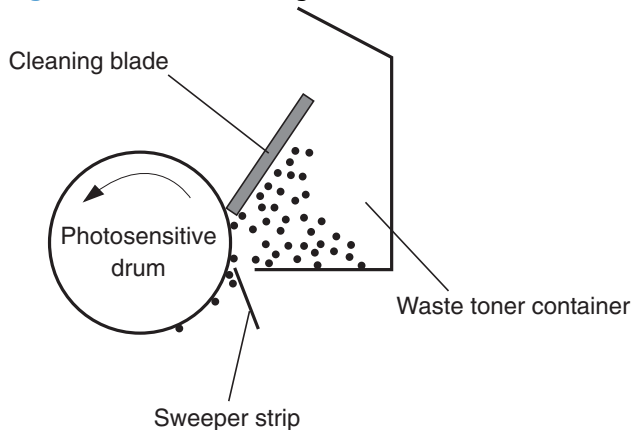

Developing roller engagement/disengagement control

The developing roller engagement/disengagement control engages the required developing roller with the photosensitive drum according to the print mode—full-color mode or monochrome mode.

The necessary developing roller is engaged with the photosensitive drum only when required, preventing a deterioration of the drums and making maximum use of the life. The engagement/disengagement of the developing roller is controlled by the DC controller rotating the main motor and changing the direction of the developing disengagement cam. The DC controller controls the developing roller state, whether engaged or disengaged, by counting the main motor rotation after it detects the signal from the developing home-position sensor.

All four color developing rollers disengage from the photosensitive drums when the product is turned on and when a print operation is completed. The color developing rollers engage with the photosensitive drums when the full-color mode is designated. Only the black developing roller engages with the photosensitive drum when the monochrome mode is designated.

The DC controller determines an abnormality of the developing roller engagement/disengagement function and notifies the formatter when it does not sense the signal from the developing home-position sensor for a specified period during the developing roller engagement/disengagement operation.

Pickup-and-feed system

The pickup-and-feed system picks up and feeds the print media. It consists of several types of feed rollers.

Figure 1-20 Pickup-and-feed system

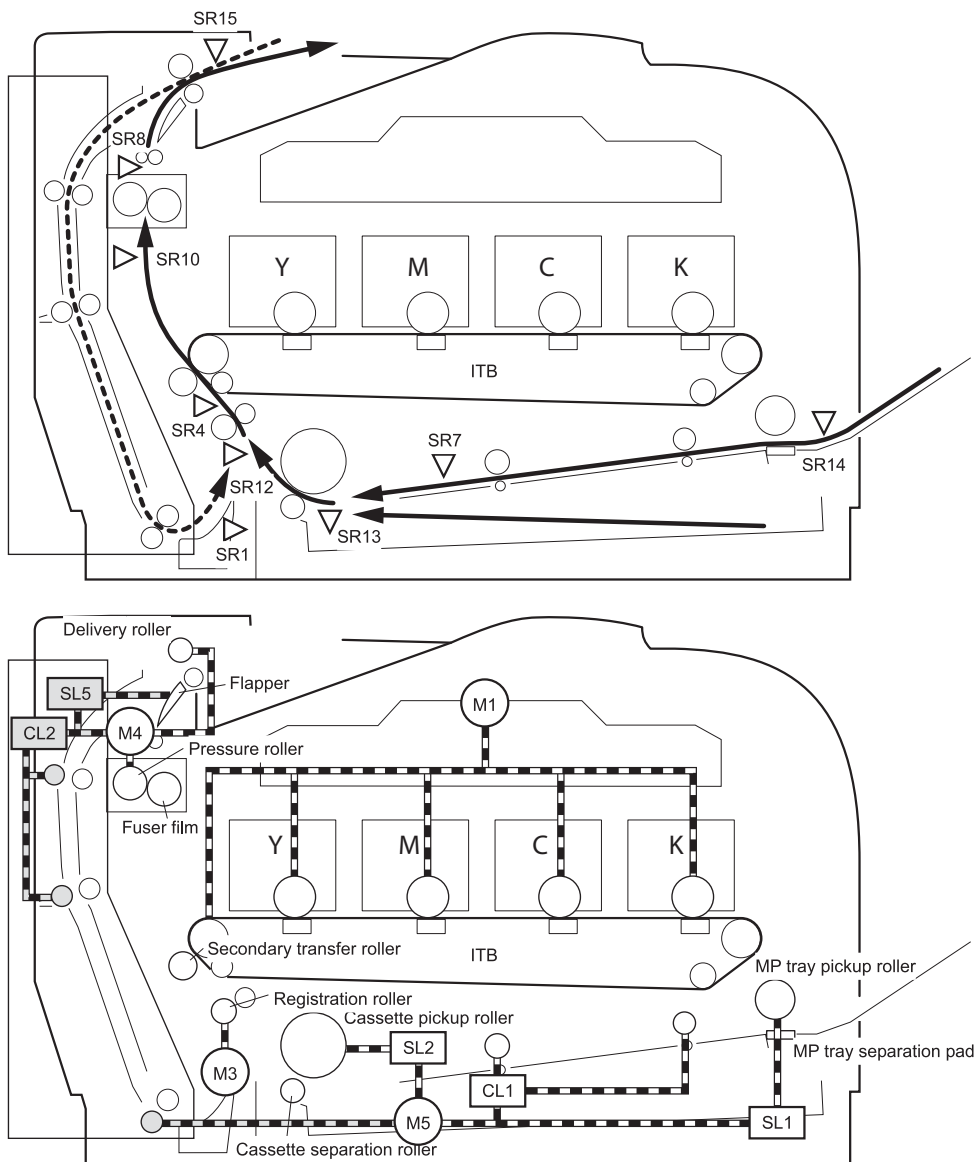

Number	Description	Number	Description
SR1	Paper feeder pre-registration sensor	M1	Drum motor
SR4	Registration sensor	M3	Registration motor
SR7	Multipurpose tray pre-registration sensor	M4	Fuser motor
SR8	Fuser delivery sensor	M5	Pickup motor

Number	Description	Number	Description
SR10	Loop sensor	SL1	Multipurpose tray pickup solenoid
SR12	Pre-registration sensor	SL2	Cassette pickup solenoid
SR13	Cassette media-presence sensor	SL5	Duplex reverse solenoid
SR14	Multipurpose tray media-presence sensor	CL1	Multipurpose tray feed clutch
SR15	Output bin media full sensor	CL2	Duplex feed clutch

Jam detection

The product uses the following sensors to detect the presence of media and to check whether media is being fed correctly or has jammed:

- Registration sensor
- Multipurpose tray pre-registration sensor
- Fuser delivery sensor
- Loop sensor
- Pre-registration sensor
- Cassette media-presence sensor
- Multipurpose tray media-presence sensor
- Output bin media full sensor
- Paper feeder pre-registration sensor

The product detects the following jams:

- Pickup delay jam
- Pickup stationary jam
- Delivery delay jam
- Delivery stationary jam
- Fuser wrapping jam
- Residual media jam
- Duplex re-pickup unit jam

Pad transfer

The product uses a pad transfer method for the primary transfer operation. The pad transfer method stabilizes an image compared to the conventional separation roller method. The wider nip width between the transfer pad and the photosensitive drum improves the transfer performance.

Multiple-feed prevention

The product uses a separation roller to prevent multiple sheets of media from entering the product. The paper separation roller follows the rotational direction of the pickup roller because it does not have its own driving force.

- **Normal-feed:** The separation roller is driven by the pickup roller through a sheet of print media. That is, the separation roller rotates in the media feed direction.
- **Multiple-feed:** The low friction force between the sheets weakens the rotational force from the pickup roller. The separation roller is limited in its rotational force and it does not rotate with such a weak driving force from the pickup roller. Since the separation roller does not rotate, the multiple sheets do not feed into the product.

The following figure illustrates the mechanism of the multiple-feed prevention.

Figure 1-21 Multiple-feed prevention

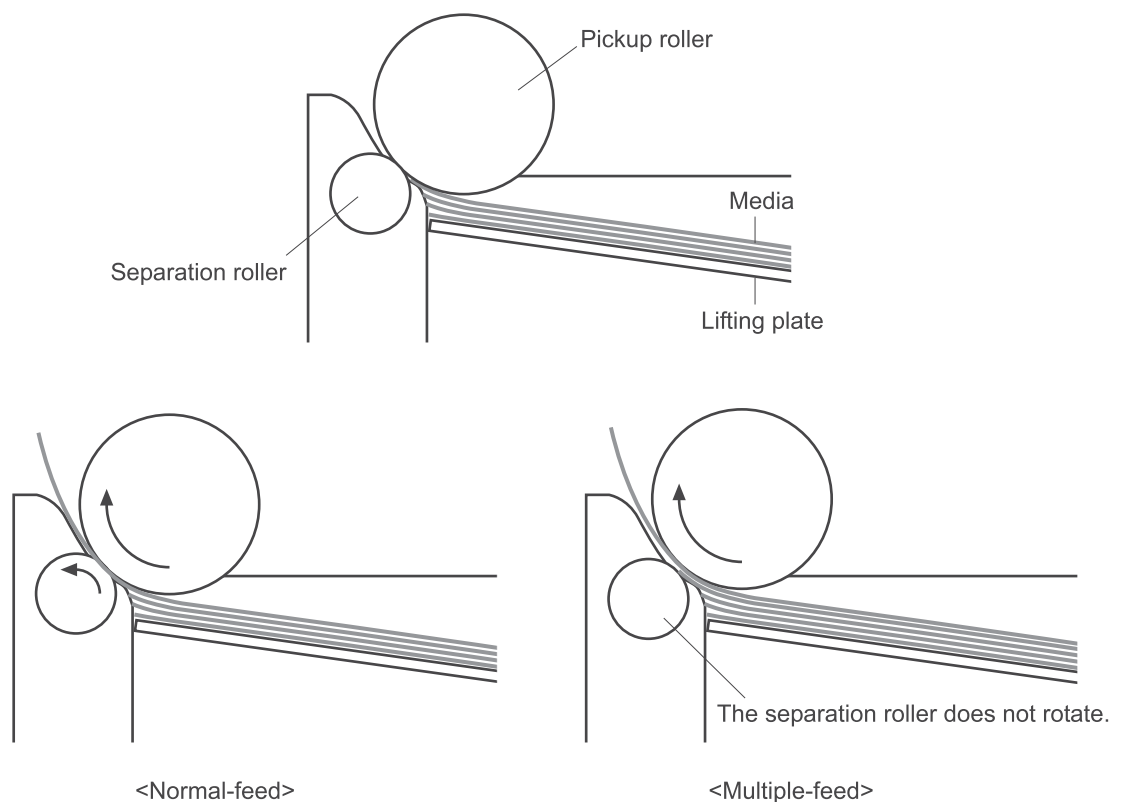

Scanning and image capture system

The flatbed image scanner captures an electronic image of the document on the glass. The scanner does this by illuminating the document with LEDs (red, green, and blue) and capturing the image in the image sensor to create an electronic format of the document. The flatbed scanner consists of three main elements.

- CIS scanner

The CIS (contact image sensor) scanner captures an image using the product's optical path. Red, green, and blue LEDs sequentially illuminate a small strip of the document (often called a raster line), and the optical system captures each color in a single row of CCD sensors that cover the entire page width. Because only one color is captured for each line per exposure, the three colors are recombined electronically to create the full color image. For monochromatic scans or copies, all three LEDs are illuminated to create a white light for the scan so the raster line can be captured in one exposure.

- Mechanical drive system

The drive system moves the CIS scanner along the document length to create the image. In this product, the drive system consists of a small DC motor with an optical encoder, a drive belt, and a guide rod. The speed of the drive system is proportional to the scan resolution (300 ppi is much faster than 1200 ppi) and also proportional to the type of scan (color scans are slower than monochromatic scans).

The carriage drive moves the CIS scan head along the document length to create the image. In this product, a small DC motor with an optical encoder creates this motion. The speed of the carriage drive is proportional to the scan resolution (300 ppi is much faster than 600 ppi) and also proportional to the type of scan (color scans are three-times slower than monochromatic scans).

- Image processing system (formatter)

The formatter processes the scanner data into either a copy or a scan to the computer. For copies, the image data is sent directly to the product without being transmitted to the computer. Depending on user selections for the copy settings, the formatter enhances the scanner data significantly before sending it to the product. Image data is captured at 300 ppi for copies and is user selectable for scans to the computer. Each pixel is represented by 8 bits for each of the three colors (256 levels for each color), for a total of 24 bits per pixel (24-bit color).

Scanner power-on sequence of events

When the product is turned on, it performs the following tests:

- **Motor test.** The product moves the motor left and right to confirm operation. It reports a scanner error 12 if no motion is detected in the motor encoder system.
- **Wall find.** The scan carriage moves slowly to the left while watching an encoder on the carriage motor to determine when the carriage has found the side wall or stop. This enables the product to identify the document origin (position of the original). If the document origin cannot be located, a default position is used instead.
- **LED check.** The product moves the carriage to the white calibration label under the left side of the flatbed image scanner, and it verifies that the minimum and maximum response is acceptable. It reports a scanner error 14 if the response is unacceptable.
- **Home find.** The scan carriage uses the optical scanner to find physical reference features that relate to the document origin at the left side of the image glass. This process ensures accurate location of the

first document pixels so that the user documents will have an accurate placement of the image on scans and copies. It reports a scanner error 6 message if the reference features are not found.

- **Calibration.** This test, also known as scanner color calibration, enables the product to identify the black and white on every pixel in the CCD. Calibration occurs in two major processes: a broad (analog) adjustment of all pixels to bring them into the target output range, and a pixel-by-pixel adjustment (digital) to fine tune the actual black and white response. The calibration process occurs under the left side of flatbed image scanner where there is a special white calibration label.

Calibration is the most important step in creating a high quality image. Calibration problems can include color inaccuracies, brightness inaccuracies, and vertical streaks through the image. The calibration process identifies any bad pixels and enables the image formatter to recreate the lost information from adjacent pixels. Extreme cases of this problem can appear as large vertical streaks or image smears. The user has no control over the calibration process itself or this pixel-replacement process.

Copy or scan sequence of events

To create an accurate rendition of a document, the scanner must be calibrated for the requested operation. If the user selects a scan at 600 ppi color, the flatbed image scanner calibrates for that specific operational mode. Subsequently, the flatbed image scanner automatically re-calibrates for the next requested operation. Calibration does not occur for every new copy request.

Normal sequence of operation for a flatbed copy or scan job includes the following.

1. LEDs illuminate.
2. Carriage motion begins moving the CIS scanner toward the right.
3. Image capture continues for the entire page or length requested in a scan operation.
4. Carriage returns to the home position on the left.

Scanner operation

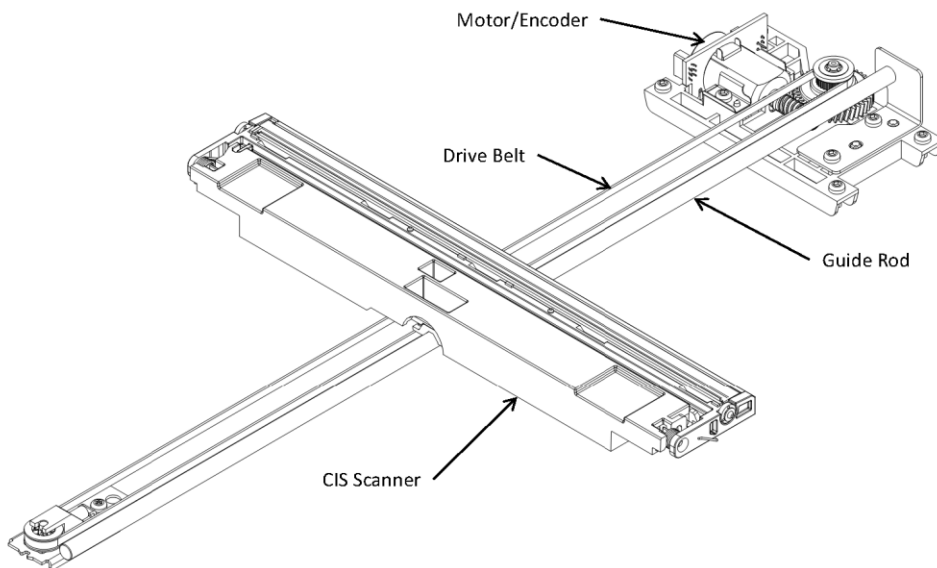

At power-on, the CIS scanner moves slowly to the left. The motor encoder is monitored to determine when the scanner has found the left side wall. The scanner then moves to the right and identifies the document origin (position of the original). If the document origin cannot be located, a default position is used.

When a copy/scan is initiated, the product first checks to determine if a document is present in the ADF. If an ADF document is detected, the scanner moves to the left side of the scan tub and scans the image as the document is fed through the ADF.

If no document is detected in the ADF, the scanner acquires the image from the flatbed by scanning while moving from left to right across the flatbed glass.

ADF operation

The ADF will not function when the ADF cover is open. The paper path is incomplete if the ADF cover is lifted from the glass.

When the product duplexes from the ADF, the paper moves through one time, because the ADF has a CIS scanner for side two which is scanned simultaneously with side one.

The standard operation of the ADF consists of the standby (paper loading) mode, pick, feed, and lift steps:

- Standby (paper-loading) mode

In standby mode, the lift plate is in the down position. When a document is loaded into the input tray, the paper-present sensor detects its presence.

When a copy/scan is initiated, the ADF motor engages the gear train and raises the lift plate until the document makes contact with the pick roller. The ADF then begins the pick, feed, and lower sequence:

- Pick

The pick roller rotates and moves one or more sheets forward into the ADF where the sheets engage with the separation roller. The separation roller contacts the ADF separation pad, which separates multiple sheets into a single sheet.

- Feed

The single sheet continues through the ADF paper path (aided by the pre-scan rollers) until the leading edge of the page activates the top-of-form sensor. Activation of this sensor initiates the scan process, and the scanner acquires the image as the document moves over the ADF glass. The post-scan rollers then eject the sheet into the output area. The pick and feed steps are repeated as long as paper is detected by the paper-present sensor.

- Home

When the form sensor detects the trailing edge of the last page, the last sheet is ejected and the motor turns on a sequence that rests the separation floor back down in standby mode, which allows it to detect when more media is loaded.

Note that the ADF will not function when the ADF door is open.

ADF duplex operation

The ADF on this product is equipped with a duplex image scanner to facilitate fast and efficient duplex copies and scans.

When a duplex copy/scan is initiated, the duplex image scanner acquires the image from the back side of the document while the flatbed image scanner simultaneously acquires the image from the front side of the document.

ADF paper path and ADF sensors

The paper-present sensor determines if paper is in the ADF. The form sensor detects the top and bottom edges of the document. One other sensor detects an open ADF door.

The following diagram shows the ADF paper path.

Figure 1-22 ADF paper path

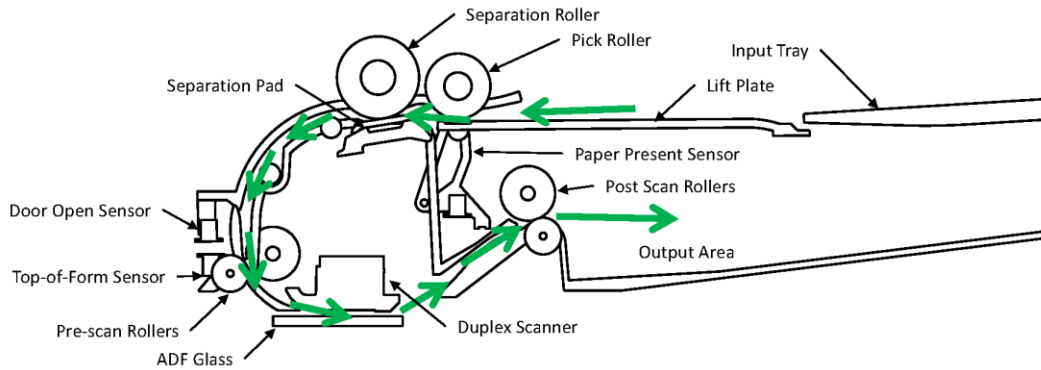

The paper-present sensor determines if paper has been loaded in the ADF. The top-of-form sensor detects the top and bottom edges of the document. The door open sensor detects when the ADF door is open.

ADF jam detection

The ADF uses two sensors to determine if a jam has occurred. The paper-present sensor detects the presence of media in the ADF input tray. The top-of-form sensor detects media moving through the ADF. A jam can be detected under any of the following conditions:

- Document feeder mispick

When a document is detected in the ADF input tray and a command to copy/scan is received, the ADF attempts to pick the page from the input tray. If the page is not picked is not successfully, the ADF will pulse the motor and cycle the lift plate in an attempt to dislodge the stuck page. Three attempts are made to advance the paper to the form sensor. If the paper does not advance, a **Document feeder mispick** message will appear on the control panel display.

- Long-document jam

If a page is picked and advanced to the top-of-form sensor, but the trailing edge of the page is not detected within the time allowed for a 381-mm (15-inch) document (the maximum allowable page length for the ADF), a **Document feeder jam** message will appear on the control panel display.

- Stall jam

When a page that is less than 381 mm (15 inches) long has advanced to the top-of-form sensor but has not left it within the expected period of time, the page has probably stalled or jammed, and a **Document feeder jam** message will appear on the control panel display.

When a jam is detected, the ADF stops feeding paper, lowers the lift plate, and displays a jam message on the control-panel display.

ADF jam clearance

Paper that has become jammed in the ADF can be retrieved at any of three access points: the input area, the scan area, or the output area.

Figure 1-23 ADF jam clearance

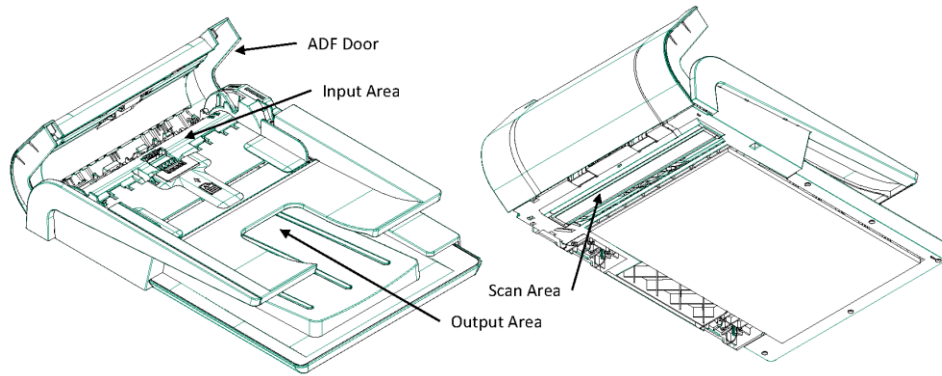

Fax functions and operation

The following sections describe the product fax capabilities.

Computer and network security features

The product can send and receive fax data over telephone lines that conform to public switch telephone network (PSTN) standards. The secure fax protocols make it impossible for computer viruses to be transferred from the telephone line to a computer or network.

The following product features prevent virus transmission:

- No direct connection exists between the fax line and any devices that are connected to the USB or Ethernet ports.
- The internal firmware cannot be modified through the fax connection.
- All fax communications go through the fax subsystem, which does not use Internet data-exchange protocols.

PSTN operation

The PSTN operates through a central office (CO) that generates a constant voltage on the TIP and RING wires (48 V, usually). A device goes on-hook by connecting impedance (such as 600 ohms for the U.S.) across the TIP and RING so that a line current can flow. The CO can detect this current and can send impulses like dial tones. The product generates more signaling tones, such as dialing digits, to tell the CO how to connect the call. The product can also detect tones, such as a busy tone from the CO, that tell it how to behave.

When the call is finally connected, the CO behaves like a piece of wire connecting the sender and receiver. This is the period during which all of the fax signaling and data transfer occurs. When a call is completed, the circuit opens again and the line-current flow ceases, removing the CO connection from both the sender and the receiver.

On most phone systems, the TIP and RING wires appear on pins 3 and 4 of the RJ-11 modular jack (the one on the fax card). These two wires do not have to be polarized because all the equipment works with either TIP or RING on pin 3 and the other wire on pin 4. This means that cables of either polarity can interconnect and will still work.

These basic functions of PSTN operation are assumed in the design of the fax subsystem. The product generates and detects the signaling tones, currents, and data signals that are required to transmit and receive faxes on the PSTN.

Receive faxes when you hear fax tones

In general, incoming faxes to the product are automatically received. However, if other devices are connected to the same phone line, the product might not be set to answer automatically.

If the product is connected to a phone line that receives both fax and phone calls, and you hear fax tones when you answer the extension phone, receive the fax in one of two ways:

- If you are near the product, press **Start Fax** on the control panel.
- Press 1-2-3 in sequence on the extension phone keypad, listen for fax transmission sounds, and then hang up.



NOTE: In order for the second method to work, the **Extension Phone** setting must be set to **Yes**.

Distinctive ring function

Ring-pattern or distinctive-ring service is available through some local telephone companies. The service allows you to have more than one telephone number on a single line. Each telephone number has a unique ring pattern, so that you can answer voice calls and the product can answer fax calls.

If you subscribe to a ring-pattern service with a telephone company, you must set the product to answer the correct ring pattern. Not all countries/regions support unique ring patterns. Contact the telephone company to determine if this service is available in your country/region.

 **NOTE:** If you do not have ring-pattern service and you change the ring-pattern settings to something other than the default, [All Rings](#), the product might not be able to receive faxes.

The settings are as follows:

- **All Rings:** The product answers any calls that come through the telephone line.
- **Single:** The product answers any calls that produce a single-ring pattern.
- **Double:** The product answers any calls that produce a double-ring pattern.
- **Triple:** The product answers any calls that produce a triple-ring pattern.
- **Double and Triple:** The product answers any calls that produce a double-ring or triple-ring pattern.

Set up the distinctive ring function

1. From the Home screen, touch the Setup  button.
2. Touch the [Fax Setup](#) menu.
3. Touch the [Basic Setup](#) menu.
4. Touch the [Distinctive Ring](#), and then touch the name of an option.

Fax by using Voice over IP services

Voice over IP (VoIP) services provide normal telephone service, including long distance service through a broadband Internet connection. These services use packets to break up the voice signal on a telephone line and transmit it digitally to the receiver, where the packets are reassembled. The VoIP services are often not compatible with fax machines. The VoIP provider must state the service supports fax over IP services.

Because the installation process varies, the VoIP service provider will have to assist in installing the product fax component.

Although a fax might work on a VoIP network, it can fail when the following events occur:

- Internet traffic becomes heavy and packets are lost.
- Latency (the time it takes for a packet to travel from its point of origin to its point of destination) becomes excessive.

If you experience problems using the fax feature on a VoIP network, ensure that all of the product cables and settings are correct. Configuring the **Fax Speed** setting to [Medium\(V.17\)](#) or [Slow\(V.29\)](#) can also improve your ability to send a fax over a VoIP network.

If you continue to have problems faxing, contact your VoIP provider.

The fax subsystem

The formatter, fax card, firmware, and software all contribute to the fax functionality. The designs of the formatter and fax card, along with parameters in the firmware, determine the majority of the regulatory requirements for telephony on the product.

The fax subsystem is designed to support V.34 fax transmission, lower speeds (such as V.17 fax), and older fax machines.

Fax card in the fax subsystem

Two versions of the fax card are used in the product. One is used in the North American, South American, and Asia Pacific countries/regions. The other is used primarily in European countries/regions.

The fax card contains the modem chipset (DSP and CODEC) that controls the basic fax functions of tone generation and detection, along with channel control for fax transmissions. The CODEC and its associated circuitry act as the third-generation silicon data access arrangement (DAA) to comply with worldwide regulatory requirements.

The only difference between the two versions is that each version is compliant with the 2/4-wire phone jack system from the respective country/region.

Safety isolation

The most important function of the fax card is the safety isolation between the high-voltage, transient-prone environment of the telephone network (TNV [telephone network voltage]) and the low-voltage analog and digital circuitry of the formatter (SELV [secondary extra-low voltage]). This safety isolation provides both customer safety and product reliability in the telecom environment.

Any signals that cross the isolation barrier do so magnetically. The breakdown voltage rating of barrier-critical components is greater than 5 kV.

Safety-protection circuitry

In addition to the safety barrier, the fax card protects against over-voltage and over-current events.

Telephone over-voltage events can be either differential mode or common mode. The event can be transient in nature (a lightning-induced surge or ESD) or continuous (a power line crossed with a phone line). The fax card protection circuitry provides margin against combinations of over-voltage and over-current events.

Common mode protection is provided by the selection of high-voltage-barrier critical components (transformer and relay). The safety barrier of the fax card PCB traces and the clearance between the fax card and surrounding components also contribute to common mode protection.

A voltage suppressor (a crowbar-type SIDACTOR) provides differential protection. This product becomes low impedance at approximately 300 V differential, and crowbars to a low voltage. A series thermal switch works in conjunction with the crowbar for continuous telephone line events, such as crossed power lines.

All communications cross the isolation barrier magnetically. The breakdown voltage rating of barrier-critical components is greater than 5 kV.

Data path

TIP and RING are the two-wire paths for all signals from the telephone network. All signaling and data information comes across them, including fax tones and fax data.

The telephone network uses DC current to determine the hook state of the telephone, so line current must be present during a call. The silicon DAA provides a DC holding circuit to keep the line current constant during a fax call.

The silicon DAA converts the analog signal to a digital signal for DSP processing, and also converts the digital signal to an analog signal for transmitting data through a telephone line.

The magnetically coupled signals that cross the isolation barrier go either through a transformer or a relay.

The DSP in the fax card communicates with the ASIC in the formatter using the high-speed serial interface.

Hook state

Another magnetically coupled signal is the control signal that disconnects the downstream telephone devices (such as a phone or answering machine). A control signal originating on the DSP can change the relay state, causing the auxiliary jack (downstream jack) to be disconnected from the telephone circuit.

The product takes control of calls that it recognizes as fax calls. If the product does not directly pick up the call, it monitors incoming calls for the fax tone or for the user to direct it to receive a fax. This idle mode is also called eavesdropping. This mode is active when the product is on-hook but current exists in the downstream phone line because another device is off-hook. During eavesdropping, the receive circuit is enabled but has a different gain from the current that is generated during normal fax transmissions.

The product does not take control of the line unless it detects a fax tone or the user causes it to connect manually. This feature allows the user to make voice calls from a phone that is connected to the product without being cut off if a fax is not being received.

Downstream current detection

The line voltage monitoring module of the silicon DAA can detect the line state as well as the downstream device. It tells DSP via DIB that an active device (telephone, modem, or answering machine) is connected to the auxiliary port on the product (the right side of the RJ-11 jack). The DSP uses the signal to ensure that the product does not go off-hook (and disconnect a downstream call) until it has been authorized to do so (by a manual fax start or the detection of the appropriate tones).

Hook switch control

In the silicon DAA the CODEC controls the hook switch directly. The CODEC is activated when it receives commands from the DSP. When the circuit is drawing DC current from the central office it is considered off-hook. When no DC current flows the state is considered on-hook.

Ring detect

Ring detect is performed by the line voltage monitoring module of the silicon DAA, and is a combination of voltage levels and cadence (time on and time off). Both must be present to detect a valid ring. The CODEC works with DSP as well as the firmware to determine if an incoming signal is an answerable ring.

Line current control

The DC current from the CO needs to have a path to flow from TIP to RING. The DC impedance emulation line modulator and DC terminations modules in the silicon DAA act as a DC holding circuit, and works with the firmware to achieve the voltage-current characteristic between TIP and RING. The impedance (the current-voltage characteristic) changes corresponding to certain special events, such as pulse dialing or when the product goes on-hook.

Billing- (metering-) tone filters

Switzerland and Germany provide high-frequency AC signals on the phone line in order to bill customers.

A filter in a special fax cable (for certain countries/regions), can filter these signals. Because these billing signals are not used in the U.S., these filters are not present in the U.S. fax cable.

To obtain a special fax cable, contact your local telephone service provider.

Fax page storage in flash memory

Fax pages are the electronic images of the document page. They can be created in any of three ways: scanned to be sent to another fax machine, generated to be sent by the computer, or received from a fax machine to be printed.

The product stores all fax pages in flash memory automatically. After these pages are written into flash memory, they are stored until the pages are sent to another fax machine, printed on the product, transmitted to the computer, or erased by the user.

These pages are stored in flash memory, which is the nonvolatile memory that can be repeatedly read from, written to, and erased. The product has 8 MB of flash memory, of which 7.5 MB is available for fax storage. The remaining 0.5 MB is used for the file system and reclamation. Adding RAM does not affect the fax page storage because the product does not use RAM for storing fax pages.

Stored fax pages

The user can reprint stored fax receive pages in case of errors. For a fax send, the product will resend the fax in case of errors. The product will resend stored fax pages after a busy signal, communication error, no answer, or power failure. Other fax devices store fax pages in either normal RAM or short-term RAM. Normal RAM immediately loses its data when power is lost, while short-term RAM loses its data about 60 minutes after power failure. Flash memory maintains its data for years without any applied power.

Advantages of flash memory storage

Fax pages that are stored in flash memory are persistent. They are not lost as a result of a power failure, no matter how long the power is off. Users can reprint faxes in case the print cartridge runs out of toner or the product experiences other errors while printing faxes.

The product also has scan-ahead functionality that makes use of flash memory. Scan-ahead automatically scans pages into flash memory before a fax job is sent. This allows the sender to pick up the original document immediately after it is scanned, eliminating the need to wait until the fax is transmission is complete.

Because fax pages are stored in flash memory rather than RAM, more RAM is available to handle larger and more complicated copy and print jobs.

USB flash drive

This product features printing from a USB flash drive. This product supports printing the following types of files from the USB flash drive.

- PDF
- RGB JPEG

When a USB flash drive is inserted into the front of the product, the control panel will display the **USB Flash Drive** menu. The files present on the USB flash drive can be accessed from the control panel using the touch screen. Any RGB jpeg or pdf files on the USB flash drive can be printed directly from the product control panel. Pages also can be scanned and saved to the USB flash drive from the control panel.

2 Solve problems

 **NOTE:** To perform diagnostic and configuration procedures (for example, resetting page counts) for the product, you must install the CP1210 Service Config Tool (available at your HP authorized repair center).

- [Solve problems checklist](#)
- [Menu structure](#)
- [Configuration report](#)
- [Troubleshooting process](#)
- [Tools for troubleshooting](#)
- [Clear jams](#)
- [Paper feeds incorrectly or becomes jammed](#)
- [Solve image-quality problems](#)
- [Solve paper-handling problems](#)
- [Clean the product](#)
- [Solve performance problems](#)
- [Solve connectivity problems](#)
- [Solve fax problems](#)
- [Solve email problems](#)
- [Validate LDAP gateway](#)
- [Product resets](#)
- [Firmware upgrades](#)

Solve problems checklist

Table 2-1 Basic problem solving

Problem	Cause	Solution
When the product is connected to a correctly grounded power source, the control panel does not illuminate and the main motor does not rotate.	No power to the product.	<ol style="list-style-type: none"> 1. Verify that the power switch is turned on. 2. Verify that the power cable is correctly connected to the outlet and the product. 3. Verify that the power outlet has the correct voltage.
	The product has an internal power failure.	Check the internal cable connections for loose connections.
	The formatter is defective.	Replace the formatter.
	The Low Voltage Power Supply is defective.	Replace the Low Voltage Power Supply.
	The High Voltage Power Supply is defective.	Replace the High Voltage Power Supply.
	The engine controller PCA is defective.	Replace the engine controller PCA.
When turned on, the control panel illuminates, but the main motor does not rotate.	The toner-cartridge door is open.	Close the toner-cartridge door.
	A page is jammed in the paper path.	Clear all paper from the paper path, and make sure that all sensors are working correctly.
	The cable is not connected correctly.	Reconnect the motor cable.
	The motor is not mounted correctly in the product chassis.	Verify that the motor is connected correctly and that it rotates freely.
	The engine controller PCA is defective.	Replace the engine controller PCA.
	The feed motor is defective.	Replace the motor.
The product turns on and the motor rotates, but the control-panel lights do not illuminate.	The control panel is disconnected, or the connection is not secure.	Verify that the control panel USB cable is connected to the formatter.
	The product firmware is out of date or corrupted.	Update the product firmware.
	The control panel is defective.	Replace the control panel.
	The formatter is defective.	Replace the formatter.
The product is on, but the control-panel indicates that the product is not in the "ready" state.	The product has an internal error that was detected during the Power-On Self-Test sequence.	Consult the list of control-panel messages to identify and correct the error.

Table 2-1 Basic problem solving (continued)

Problem	Cause	Solution
The product prints the engine test and the Demo page, but does not print jobs from a computer.	The network or USB cable is not connected correctly.	Reconnect the cable. TIP: Try using a new USB cable that is 3 m (10 ft) or less in length.
	An incorrect driver is selected.	Select the correct print driver.
	The print driver is not installed correctly.	Remove and then reinstall the product software. Make sure that you use the correct procedure and port setting.
	Other devices are connected to the product (for example, through a switch or hub) that are interfering with the computer-product communications.	Disconnect the other devices, switches, or hubs.
	There is a computer-port communications problem.	Reset the computer port settings (see the computer user guide for more information).
	The formatter is defective.	Replace the formatter.

Menu structure

To enable you to more easily navigate to individual settings, you can print a report of the complete menu structure:

1. From the Home screen on the product control panel, touch [Service](#).
2. Touch [Reports](#).
3. Touch [Menu Structure](#). The product prints the menu structure report.
4. To return to the Home screen, touch the [Home](#) button.

Configuration report

The configuration report provides a list of the user-configurable settings. This report might be useful in the troubleshooting process. To print the configuration report:

1. From the Home screen on the product control panel, touch [Service](#).
2. Touch [Reports](#).
3. Touch [Configuration Report](#). The product prints the configuration report.
4. To return to the Home screen, touch the [Home](#) button.

Troubleshooting process

Determine the problem source

The following table includes basic questions to ask the customer to quickly help define the problem.

General topic	Questions
Environment	<ul style="list-style-type: none">• Is the product installed on a solid, level surface ($\pm 1^\circ$)?• Is the power-supply voltage within ± 10 volts of the specified power source?• Is the power-supply plug inserted in the product and the outlet?• Is the operating environment within the specified parameters?• Is the product exposed to ammonia gas, such as that produced by diazo copiers or office cleaning materials? NOTE: Diazo copiers produce ammonia gas as part of the copying processes. Ammonia gas (from cleaning supplies or a diazo copier) can have an adverse affect on some product components (for example, the toner-cartridge imaging drum).• Is the product exposed to direct sunlight?
Paper	<ul style="list-style-type: none">• Does the customer use only supported paper?• Is the paper in good condition (no curls, folds, or distortion)?• Is the paper stored correctly and within environmental limits?
Input trays	<ul style="list-style-type: none">• Is the amount of paper in the tray within specifications?• Is the paper correctly placed in the tray?• Are the paper guides aligned with the stack?
Toner cartridge	<ul style="list-style-type: none">• Is the toner cartridge installed correctly? NOTE: Check for an empty, refilled, or cloned toner cartridge.
Transfer roller and fuser	<ul style="list-style-type: none">• Are the transfer roller and fuser installed correctly? NOTE: Check for fuser film damage or a contaminated or dirty transfer roller.
Toner-cartridge door	<ul style="list-style-type: none">• Is the toner-cartridge door closed? NOTE: Check for a damaged door interlock switch or cabling.
Condensation	<ul style="list-style-type: none">• Does condensation occur following a temperature change (particularly in winter following cold storage)? If so, wipe affected parts dry or leave the product on for 10 to 20 minutes.• Was a toner cartridge opened soon after being moved from a cold to a warm room? If so, allow the toner cartridge to sit at room temperature for 1 to 2 hours.
Miscellaneous	<ul style="list-style-type: none">• Check for and remove any non-HP components (for example, a toner cartridge) from the product.• Remove the product from the network and make sure that the failure is with the product before beginning troubleshooting.

Power subsystem

Power-on checks

Turn on the power. If the control panel does not illuminate, perform the power-on checks to find the cause of the problem.

1. Verify that the product is plugged into an active electrical outlet that delivers the correct voltage.
2. Verify that the power switch is in the on position.
3. Make sure that the product makes the expected start up sounds.

 **NOTE:** The over-current/over-voltage protection circuit in the low-voltage power supply unit might be functioning. Turn the product off, unplug the power cord, and turn the product on. If the product does not function, the fuse melts, or the power supply is malfunctioning, replace the engine controller unit.

Control-panel checks

Use the product control panel to conduct tests on the control panel LEDs, display, or buttons.





 **NOTE:** When the menus are accessed, some of the touchscreen buttons located along the sides of the control-panel display are not illuminated. Use the figure below to locate the Cancel  button and the left arrow button to access the control-panel tests.

Figure 2-1 Control-panel [2ndary Service](#) test access buttons



1. From the Home screen on the product control panel, touch the Setup  button.
2. From the Setup Menu screen, simultaneously touch the non-illuminated left arrow button  and the Cancel . This will activate the 2ndary Service Menu.
3. After touching both buttons, the Home screen appears. Touch the Setup Menu icon to access the 2ndary Service Menu bar.
4. From the Service Menu, touch the [2ndary Service](#) menu bar.

Tools for troubleshooting

The section describes the tools that can help you solve problems with your product.

Individual component diagnostics

Tools for troubleshooting: LED diagnostics

Network LEDs

The onboard network solution has two network port LEDs. When the product is connected to a properly working network through a network cable, the yellow LED indicates network activity, and the green LED indicates the link status. A blinking yellow LED indicates network traffic. If the green LED is off, a link has failed.

For link failures, check all of the network cable connections. In addition, you can try to manually configure the network card link speed setting by using the product control-panel.

Troubleshooting tools: Change the Link Speed setting

1. From the Home screen on the product control panel, touch the Setup  button.
2. Scroll to, and then touch the [Network Setup](#) menu.
3. Scroll to, and then touch [Link Speed](#) item.
4. Touch the appropriate link speed.

Control panel LEDs

The state of the Ready light and Attention light on the product signal the product status. The following table outlines the possible control-panel light states.

Product state	Ready light state	Attention light state
Initializing	Blinking	Blinking
Ready	On	Off
Receiving data/processing job or cancelling job	Blinking	Off
Error message	Off	Blinking
Fatal error (49 or 79 error) ¹	On	On

¹ The product will power off and then power on after one of these errors occurs.

Tools for troubleshooting: Engine diagnostics

Engine-test button

The engine test produces a single-sided sheet with horizontal lines when you perform the engine test.

To perform the test, use a small-pointed object, for example a straightened paper clip, to push the engine test button (accessed through a small hole in the rear cover). If the engine is functioning properly, the product will initialize and then print the test page.

Figure 2-2 Engine test button access



Drum rotational check

The photosensitive drum, located in the toner cartridge, must rotate for the print process to work. The photosensitive drum receives its drive from the main drive assembly.

 **NOTE:** This test is especially important if refilled toner cartridges have been used.

1. Open the toner-cartridge door.
2. Remove the toner cartridge.
3. Mark the drive gear on the cartridge with a felt-tipped marker. Note the position of the mark.
4. Replace the toner cartridge and close the toner-cartridge door. The startup sequence should rotate the drum enough to move the mark.
5. Open the toner-cartridge door and inspect the gear that was marked in step 3. Verify that the mark moved.

If the mark did not move, inspect the main drive assembly to make sure that it is meshing with the toner-cartridge gears. If the drive gears appear functional and the drum does not move, replace the toner cartridge.

Half self-test functional check

The half self-test check determines which printing process is malfunctioning. This process requires you to stop the product while it is in the process of printing a page.

1. Print a Configuration page.
 - a. From the Home screen on the product control panel, touch the Setup Setup  button.
 - b. Touch [Reports](#).
 - c. Touch [Configuration Report](#) to begin printing the report.
2. Open the toner-cartridge-door after the paper advances halfway through the product (about five seconds after the motor begins rotating). The leading edge of the paper should have advanced past the toner cartridge.
3. Remove the toner cartridge.
4. Open the toner-cartridge drum shield to view the drum surface. If a dark and distinct toner image is present on the drum surface, assume that the first two functions of the electrophotographic process are functioning (image formation and development). Troubleshoot the failure as a transfer or fusing problem.

If there is no image on the photosensitive drum, perform these checks:

1. Make sure you removed the entire length of the sealing tape from the toner cartridge before you installed the cartridge.
2. Perform a drum rotation functional check to make sure that the drum is rotating.
3. Make sure that the high-voltage contacts are clean and not damaged.

Diagrams

Diagrams: Formatter connections

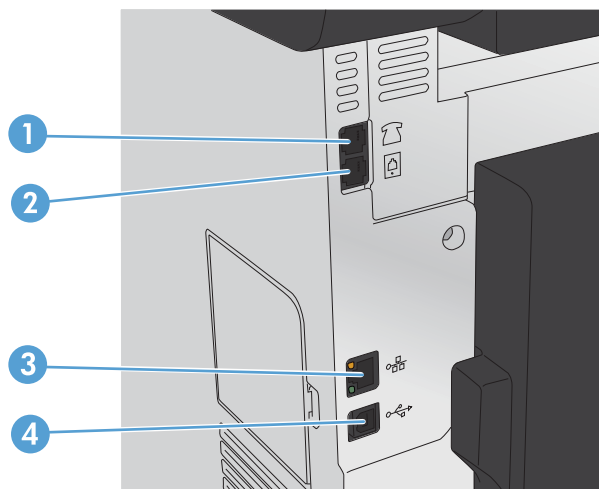

- | | |
|---|--|
| 1 | Telephone "line out" port for attaching an extension phone, answering machine, or other device |
| 2 | Fax "line in" port for attaching fax line to product |
| 3 | Network port |
| 4 | Hi-Speed USB 2.0 port |

Diagrams: Location of major components

Major components

Figure 2-3 Major components

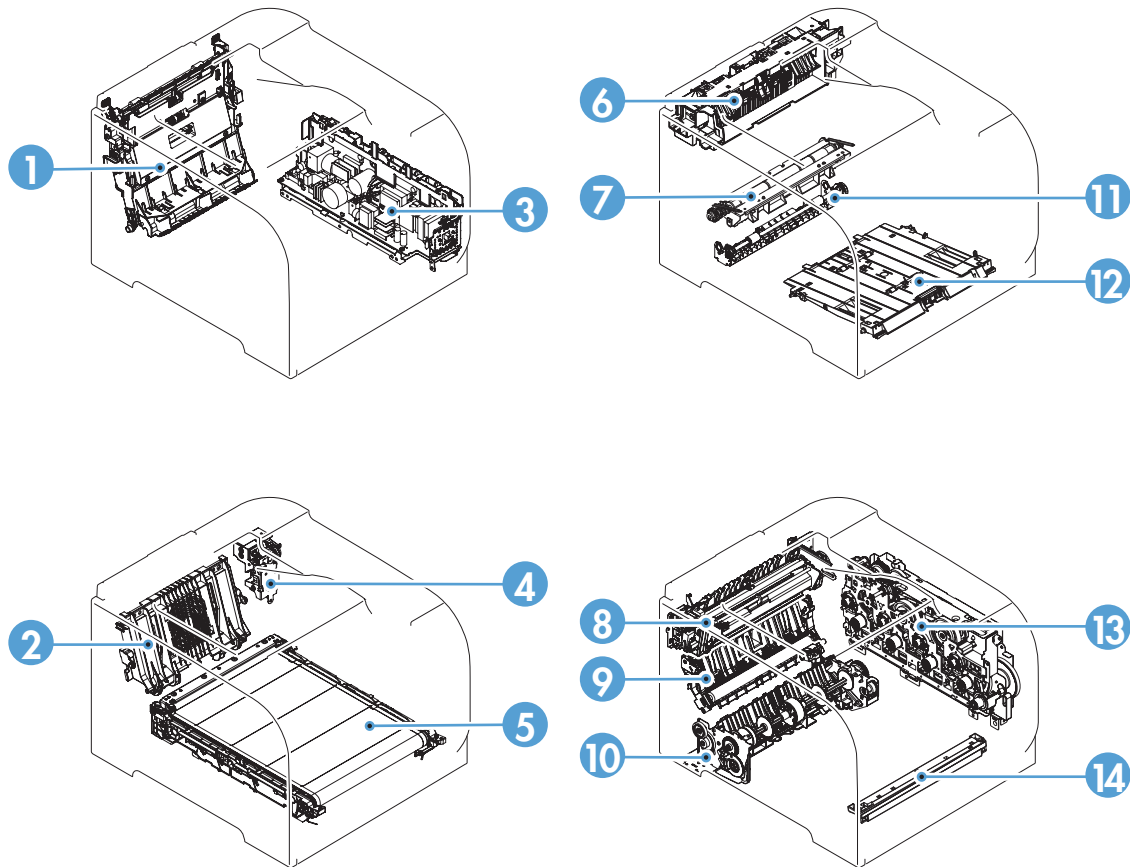

Table 2-2 Major components

Item	Description
1	Duplex feed assembly
2	Rear door rib assembly
3	Power supply assembly
4	Duplex reverse drive assembly
5	ITB assembly
6	Delivery assembly
7	Registration assembly
8	Fuser assembly
9	Secondary transfer feed assembly
10	Cassette pickup assembly
11	Duplex re-pickup guide assembly
12	Multipurpose tray pickup assembly

Table 2-2 Major components (continued)

Item	Description
13	Drive assembly
14	Color misregistration and density sensor

Motors and fans

Figure 2-4 Motors and fans



Table 2-3 Solenoid, sensors, and motors

Item	Description
1	Fuser motor
2	Drum motor (M1)
3	Developing motor (M2)
4	Fan 1
5	Fan 2
6	Pickup motor

Rollers

Figure 2-5 Rollers



Table 2-4 Rollers

Item	Description
1	Cassette pickup roller
2	Multipurpose tray pickup roller
3	Multipurpose tray separation pad
4	Cassette separation roller

PCAs

Figure 2-6 PCAs

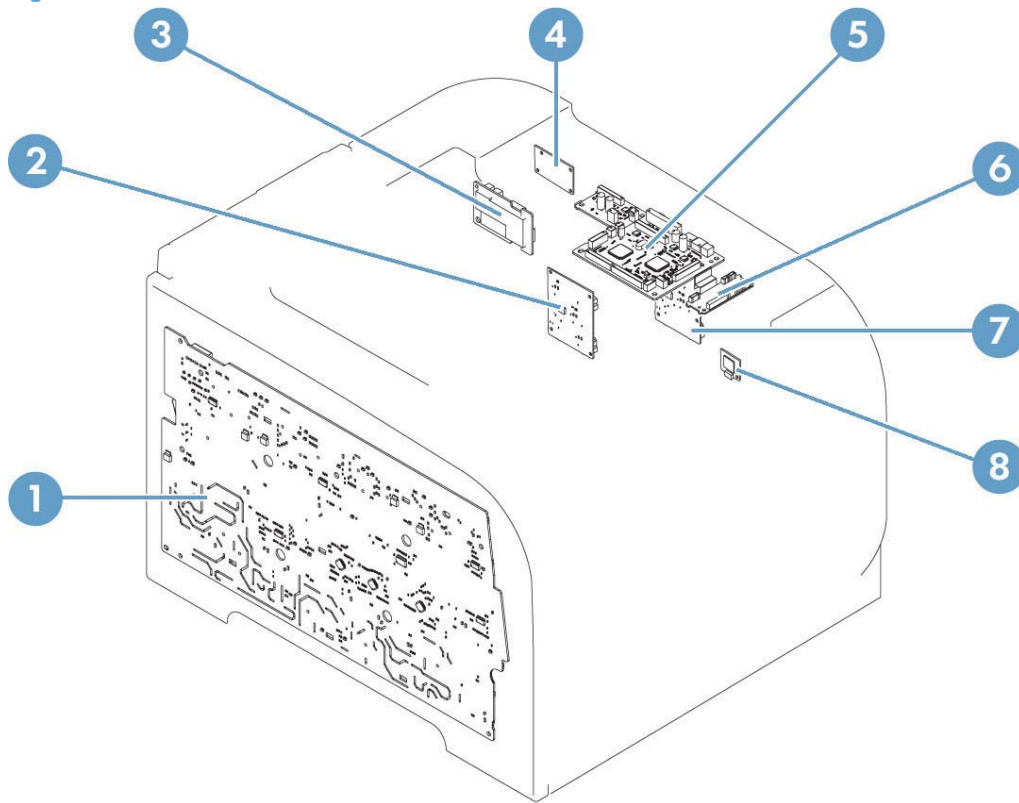

Table 2-5 PCAs

Item	Description
1	High-voltage power supply PCA
2	Formatter
3	Sub-power supply PCA
4	Fax PCA
5	DC controller PCA
6	Connector PCA
7	Driver PCA
8	Wireless PCA

Optional 250-sheet cassette

Figure 2-7 Optional 250-sheet cassette

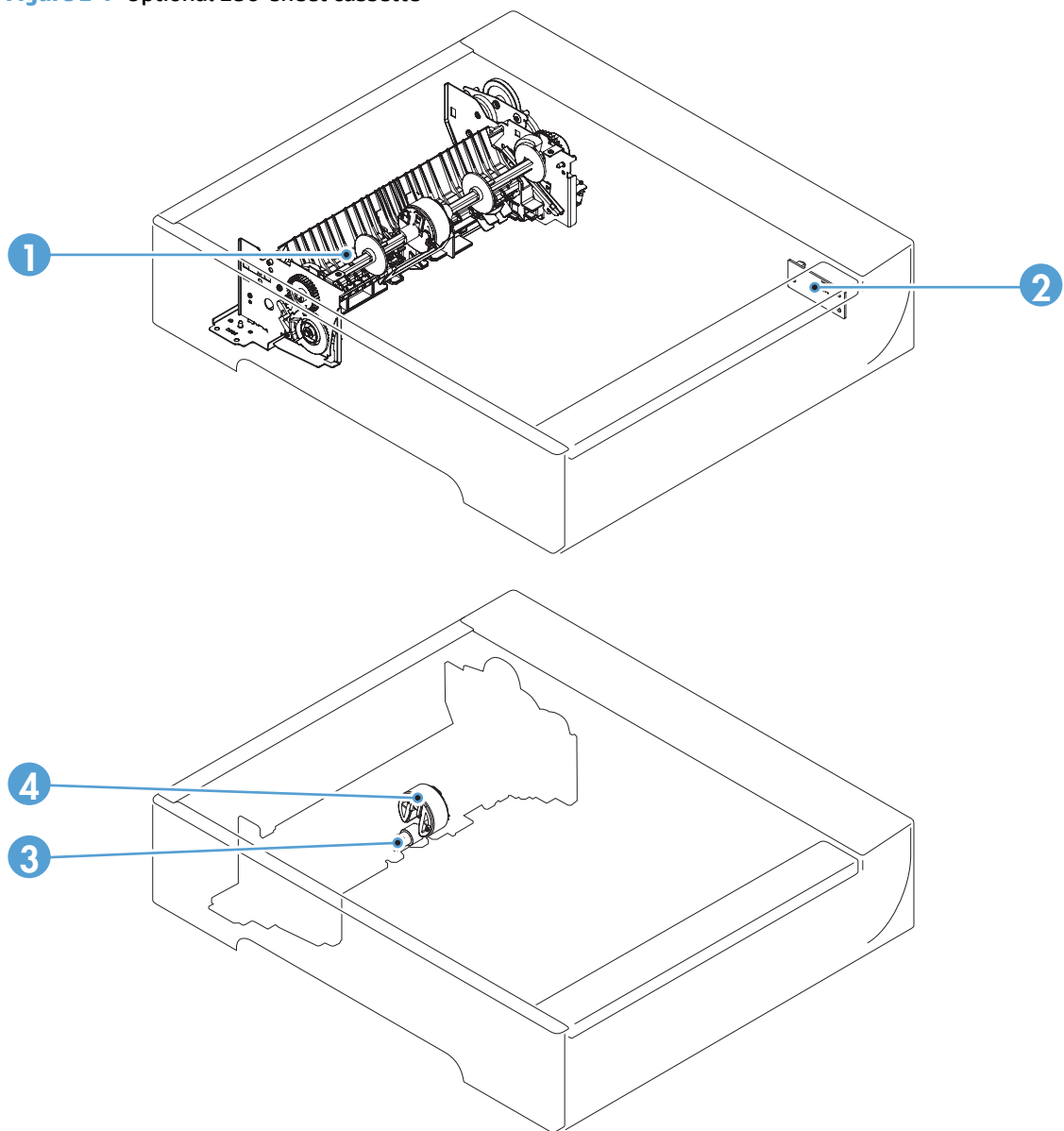
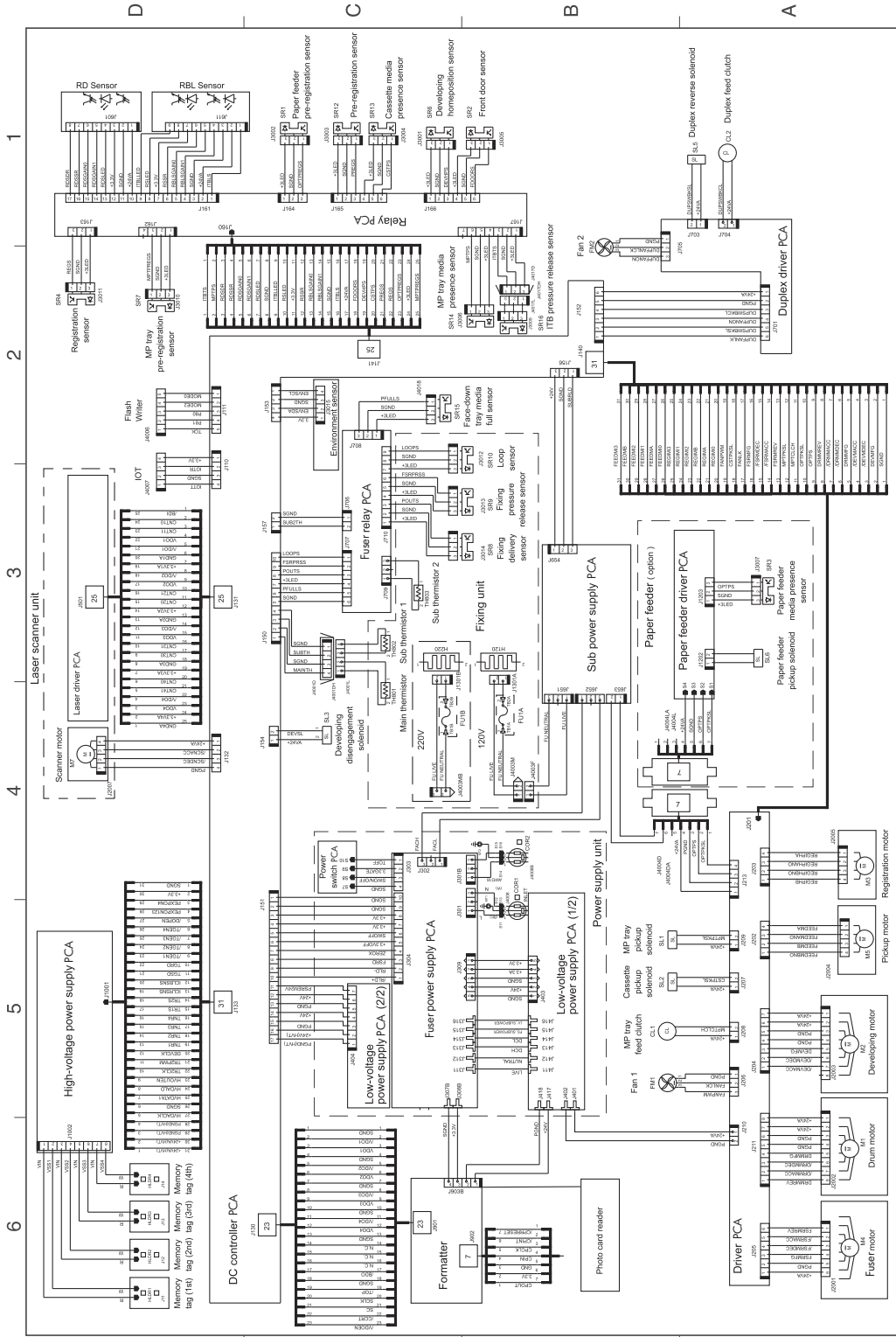

Table 2-6 Optional 250-sheet cassette

Item	Description
1	Paper feeder pickup assembly
2	Paper feeder connector PCA
3	Paper feeder separation roller
4	Paper feeder pickup roller

Diagrams: Circuit diagram

Figure 2-9 Circuit diagram



Diagrams: CPU/ASIC diagrams

Figure 2-10 CPU diagram

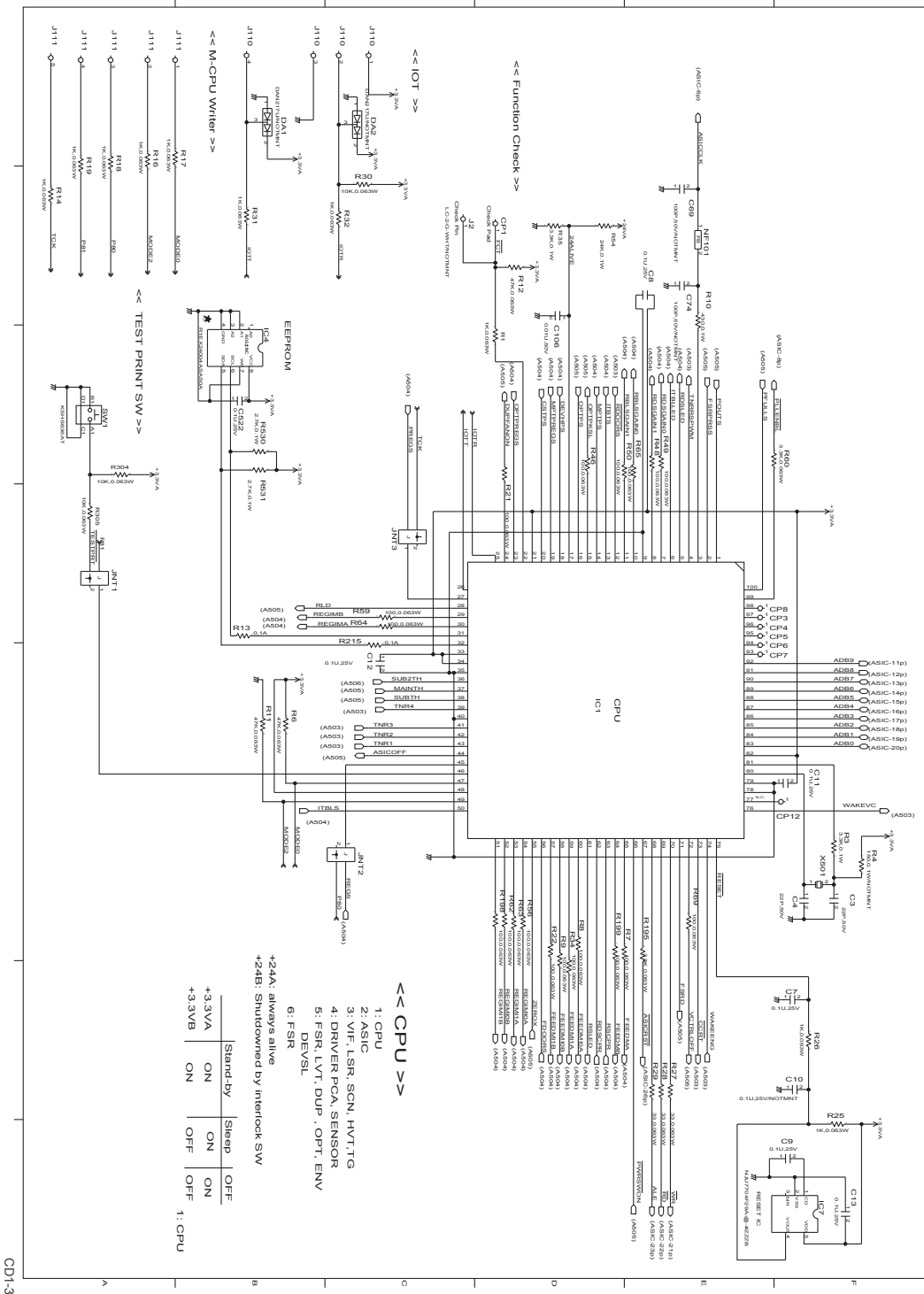

CD1-3

Figure 2-11 ASIC diagram

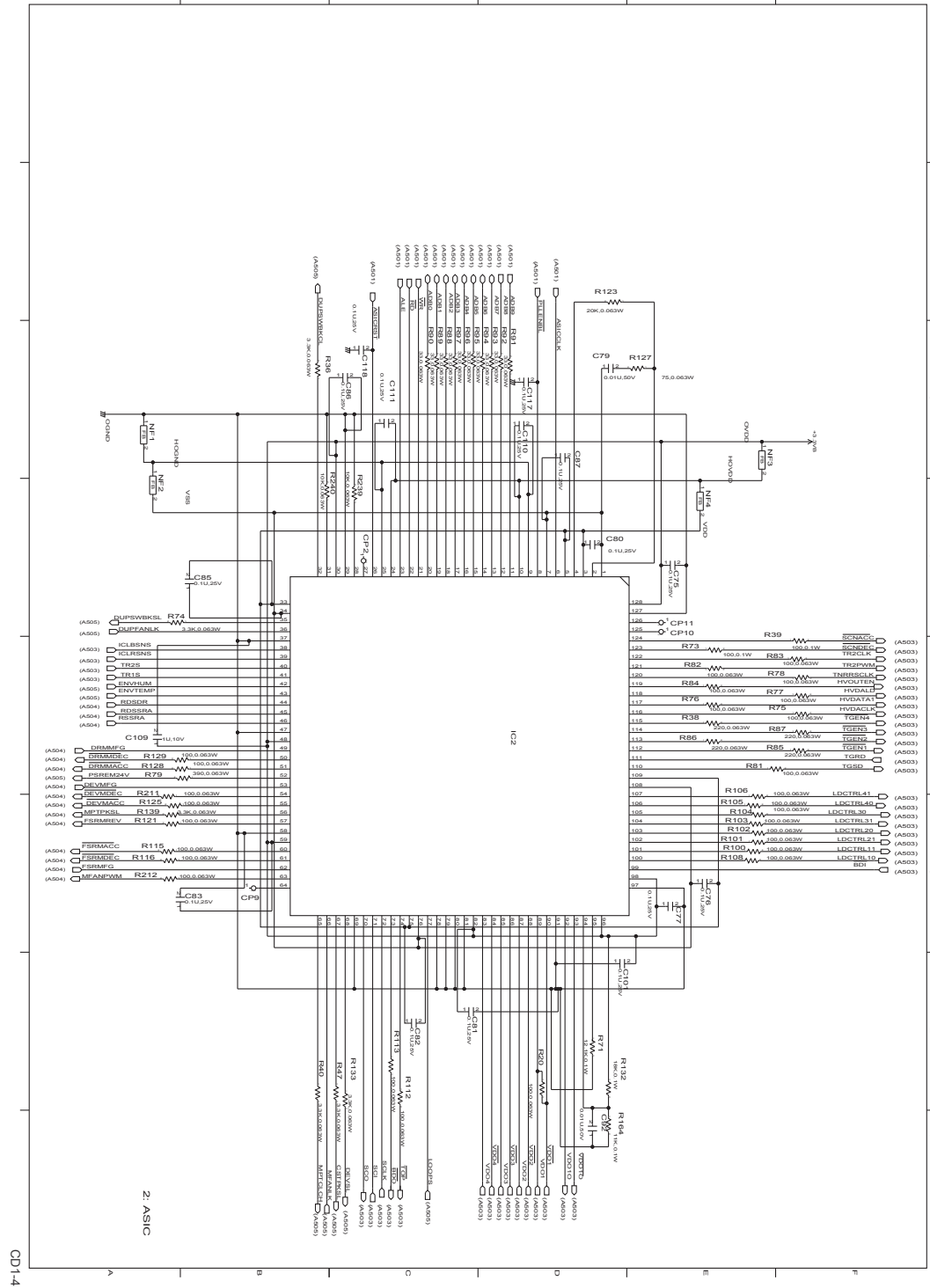

Diagrams: FSR diagram

Figure 2-15 FSR diagram

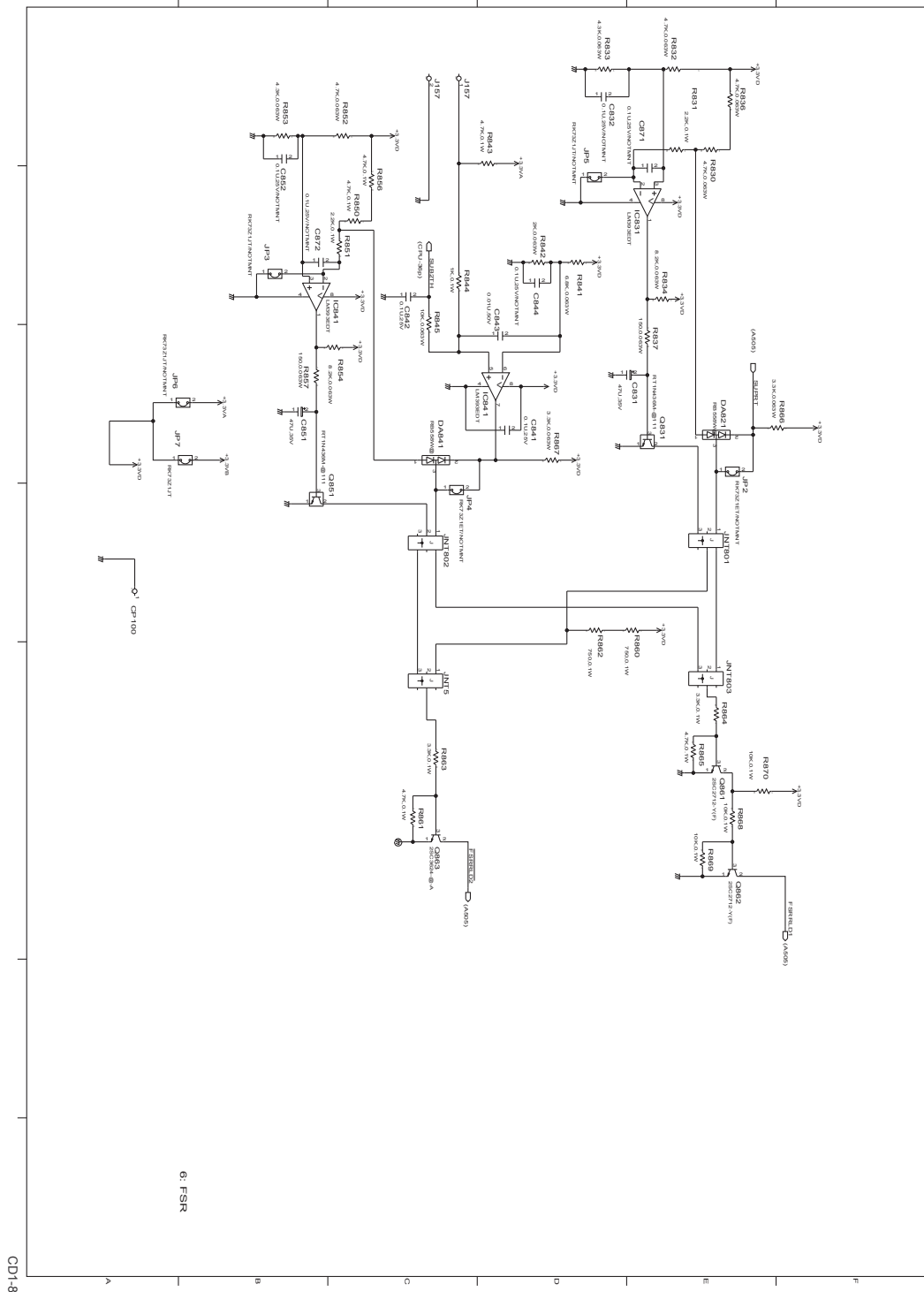

Print-quality troubleshooting tools

Print-quality troubleshooting tools: Repetitive defects ruler

Defects on product rollers can cause image defects to appear at regular intervals on the page, corresponding to the circumference of the roller that is causing the defect. Measure the distance between defects that recur on a page. Use the following table or the repetitive-defect ruler to determine which roller is causing the defect. To resolve the problem, try cleaning the roller first. If the roller remains dirty after cleaning or if it is damaged, replace the part that is indicated in [Table 2-7 Repetitive defects on page 64](#).

 **CAUTION:** Do not use solvents or oils to clean rollers. Instead, rub the roller with lint-free paper. If dirt is difficult to remove, rub the roller with lint-free paper that has been dampened with water.

 **NOTE:** The following table replaces the graphical repetitive defect ruler. You can make your own ruler by using these measurements. For the most accurate results, use a metric ruler.

Table 2-7 Repetitive defects

Component	Distance between defects
Primary charging roller	38 mm (1.5 in)
Transfer roller	39 mm (1.54 in)
Developer roller	42 mm (1.65 in)
Registration roller	43 mm (1.69 in)
Fuser film	57 mm (2.24 in)
Pressure roller	63 mm (2.48 in)
Photosensitive drum	75 mm (2.95 in)

Tools for troubleshooting: Control panel menus

Setup menu

To open this menu, touch the Setup  button. The following sub-menus are available:

- HP Web Services
- Reports
- Self Diagnostics
- Fax Setup
- System Setup
- Service
- Network Setup
- Quick Forms

HP Web Services menu



 **NOTE:** This menu is also available by touching the Web Services  button on the Home screen.

Table 2-8 HP Web Services menu

Menu item	Description
Enable Web Services	If no wired or wireless network connection is available or if Web Services is disabled, use Enable Web Services to set up Web Services on the product. NOTE: You must be connected to a network to enable HP Web Services.
Display E-mail Address	If Web Services is enabled, this option displays the product ePrint email address.
Print Information Sheet	If Web Services is enabled, this option prints the HP ePrint mobile printing report. Use this report to setup ePrint in ePrint Center.
Turn ePrint On/Off	If Web Services is enabled, use this option to turn the ePrint function on or off.
Turn Apps On/Off	If Web Services is enabled, use this option to turn apps on or off.
Remove Web Services	If Web Services is enabled, use this option to disable Web Services and remove the ePrint address.
Proxy Settings	The Proxy Settings sub-menu includes the following: <ul style="list-style-type: none">• Proxy Server• Proxy Port• User Name• Password

Reports menu

Table 2-9 Reports menu

Menu item	Description
Demo Page	Prints a page that demonstrates print quality.
Fax Reports	Prints various fax reports. Report options include the following: <ul style="list-style-type: none">Fax Activity ReportPhone Book
Menu Structure	Prints a map of the control panel-menu layout. The active settings for each menu are listed.
Configuration Report	Prints a list of all the product settings. Includes basic network information when the product is connected to a network.
Supplies Status	Prints the status for each toner cartridge, including the following information: <ul style="list-style-type: none">Estimated percentage of cartridge life remainingApproximate pages remainingPart numbers for HP toner cartridgesNumber of pages printed
Network Summary	Prints a list of all product network settings
Usage Page	Prints a page that lists PCL pages, PCL 6 pages, PS pages, pages that were jammed or mispicked in the product, monochrome (black and white) or color pages; and reports the page count
PCL Font List	Prints a list of all the PCL fonts that are installed
PS Font List	Prints a list of all the PostScript (PS) fonts that are installed
PCL6 Font List	Prints a list of all the PCL6 fonts that are installed
Color Usage Log	Prints a report that shows the user name, application name, and color usage information on a job-by-job basis
Service Page	Prints the service report
Diagnostics Page	Prints the calibration and color diagnostics pages
Print Quality Page	Prints a page that helps solve problems with print quality
Default Info Page	Prints a page that lists the default settings for the product.

Self Diagnostics menu

Table 2-10 Self Diagnostics menu

Menu item	Description
Run Wireless Test	Performs a wireless network test and prints the results.
Run Fax test	Performs a fax connectivity test and prints the results.

Fax Setup menu

In the following table, items that have an asterisk (*) indicate the factory default setting.

Table 2-11 Fax Setup menu

Menu item	Sub-menu item	Sub-menu item	Description
Fax Set-Up Utility			This is a tool for configuring the fax settings. Follow the on-screen prompts and select the appropriate response for each question.
Basic Setup	Time/Date	12 Hour	Sets the time and date setting for the product.
		24 Hour	
	Fax Header		Sets the identifying information that is sent to the receiving product.
	Answer Mode	Automatic*	Sets the type of answer mode. The following options are available: <ul style="list-style-type: none"> • Automatic: The product automatically answers an incoming call on the configured number of rings. • Manual: The user must touch the Start Fax button or use an extension phone number to make the product answer the incoming call. • TAM: A telephone answering machine (TAM) is attached to the Auxiliary phone port of the product. The product will not pick up any incoming call, but will listen for fax tones after the answering machine has picked up the call. • Fax/Tel: The product must automatically pick up the call and determine if the call is a voice or fax call. If the call is a fax call, the product handles the call as usual. If the call is a voice call, an audible synthesized ring is generated to alert the user of an incoming voice call.
Manual			
TAM			
Fax/Tel			
	Rings to Answer		Sets the number of rings that must occur before the fax modem answers. The default setting is 5.
	Distinctive Ring	All Rings*	If you have distinctive ring phone service, use this item to configure how the product responds to incoming calls. <ul style="list-style-type: none"> • All Rings: The product answers any calls that come through the telephone line. • Single: The product answers any calls that produce a single-ring pattern. • Double: The product answers any calls that produce a double-ring pattern. • Triple: The product answers any calls that produce a triple-ring pattern. • Double and Triple: The product answers any calls that produce a double-ring or triple-ring pattern.
Single			
Double			
Triple			
Double and Triple			

Table 2-11 Fax Setup menu (continued)

Menu item	Sub-menu item	Sub-menu item	Description
	Dial prefix	On Off*	Specifies a prefix number that must be dialed when sending faxes from the product.
Advanced setup	Fax Resolution	Standard Fine* Superfine Photo	Sets the resolution for sent documents. Higher resolution images have more dots per inch (dpi), so they show more detail. Lower resolution images have fewer dots per inch and show less detail, but the file size is smaller and the fax takes less time to transmit.
	Lighter/Darker		Sets the darkness for outgoing faxes.
	Fit to Page	On* Off	Shrinks incoming faxes that are larger than the paper size set for the tray.
	Glass Size	Letter* A4	Sets the default paper size for documents being scanned from the flatbed scanner. NOTE: The default setting is determined by the choice of location during the initial product setup.
	Dialing Mode	Tone* Pulse	Sets whether the product should use tone or pulse dialing.
	Redial if Busy	On* Off	Sets whether the product should attempt to redial if the line is busy.
	Redial if No Answer	On Off*	Sets whether the product should attempt to redial if the recipient fax number does not answer.
	Redial if Comm. Error	On* Off	Sets whether the product should attempt to redial the recipient fax number if a communication error occurs.
	Detect Dial Tone	On* Off	Sets whether the product should check for a dial tone before sending a fax.
	Extension Phone	On* Off	When this feature is enabled, the 1-2-3 buttons on the extension phone may be pressed to cause the product to answer an incoming fax call.
	Stamp Faxes	On Off*	Sets the product to print the date, time, sender's phone number, and page number on each page of incoming faxes.
	Private Receive	On Print faxes Off*	Setting Private Receive to On requires you to set a product password. After setting the password, the following options are set: <ul style="list-style-type: none"> • Private Receive is turned on. • All old faxes are deleted from memory. • Fax forwarding is set to Off and is not allowed to be changed. • All incoming faxes are stored in memory.

Table 2-11 Fax Setup menu (continued)

Menu item	Sub-menu item	Sub-menu item	Description
	Allow Fax Reprint	On* Off	Sets whether incoming faxes are stored in memory for reprinting later.
	Fax/Tel Ring Time		Sets the time, in seconds, after which the product should stop sounding the Fax/Tel audible ring to notify the user of an incoming voice call. The default setting is 20 seconds.
	Fax Speed	Fast(V.34)* Medium(V.17) Slow(V.29)	Sets the allowed fax communication speed.

System Setup menu

In the following table, items that have an asterisk (*) indicate the factory default setting.

Table 2-12 System Setup menu

Menu item	Sub-menu item	Sub-menu item	Description
Language	(Lists available control-panel display languages.)		Sets the language in which the control panel displays messages and product reports.
Paper Setup	Paper Size	Letter A4 Legal	Sets the size for printing internal reports, faxes, or any print job that does not specify a size. NOTE: The default setting is determined by the choice of location during the initial product setup.
	Paper Type	(Lists available paper types.)	Sets the type for printing internal reports, faxes, or any print job that does not specify a type.
Print Density			Determines how much toner to apply to thicken lines and edges.
Energy Settings	Sleep/Auto Off After	5 Minutes 15 Minutes 30 Minutes 60 Minutes	Specifies the amount of idle time before the product enters sleep mode.
	Wake/Auto On Events	Control Panel Touch USB Job LAN Job Wireless Job Fax	Select the events that bring the product out of sleep mode.

Table 2-12 System Setup menu (continued)

Menu item	Sub-menu item	Sub-menu item	Description
	Auto Off/Manual On After	Never 2 Hours 4 Hours 8 Hours	Set the amount of elapsed time before the product turns itself off.
Supply Settings	Black Cartridge Color Cartridges	Very Low Setting	<ul style="list-style-type: none"> • Stop: The product stops printing until you replace the toner cartridge. • Prompt: The product stops printing and prompts you to replace the toner cartridge. You can acknowledge the prompt and continue printing. • Continue* The product alerts you that the toner cartridge is very low, but it continues printing.
		Low Threshold	Enter a percentage for the low threshold setting.
	Store Usage Data	Not on Supplies* On Supplies	Select where to store the product's usage data, either on the supplies or not on the supplies.
Volume Settings	Alarm Volume Ring Volume Key-Press Volume Phone Line Volume		<p>Set the volume levels for the product. The following options are available for each volume setting:</p> <ul style="list-style-type: none"> • Off • Soft* • Medium • Loud
Time/Date	12 Hour 24 Hour		Sets the time and date setting for the product.
Administration	Product Security	<ul style="list-style-type: none"> • On • Off* 	Enable or disable the password feature.
	USB Flash Drive	<ul style="list-style-type: none"> • On* • Off 	Enable or disable the USB Flash Drive feature.
	Disable Fax	<ul style="list-style-type: none"> • On • Off* 	Enable or disable the fax feature.
	Scan to Network Folder	<ul style="list-style-type: none"> • On* • Off 	Enable or disable the Scan to Network Folder feature.
	Scan to email	<ul style="list-style-type: none"> • On* • Off 	Enable or disable the Scan to email feature.
	Color Copy	<ul style="list-style-type: none"> • On* • Off 	Enable or disable color copying.

Table 2-12 System Setup menu (continued)

Menu item	Sub-menu item	Sub-menu item	Description
Inactivity Timer			Enable or disable the inactivity timer. (If a user is signed in and walks away, the inactivity timer automatically signs the user out.)
Courier Font			Adjust the display font contrast.

Service menu

In the following table, items that have an asterisk (*) indicate the factory default setting.

Table 2-13 Service menu

Menu item	Sub-menu item	Sub-menu item	Description
Fax Service	Clear Saved Faxes		Clears all faxes in memory.
	Run Fax Test		Performs a fax test to verify that the phone cord is plugged in the correct outlet and that there is a signal on the phone line. A fax test report is printed indicating the results.
	Print T.30 Trace		Prints or schedules a report that is used to troubleshoot fax transmission issues. Schedule options include the following: <ul style="list-style-type: none"> Now Never* If Error At End of Call
	Error Correction		The error correction mode allows the sending device to re-transmit data if it detects an error signal.
	Fax Service Log		The fax service log prints out the last 40 entries in the fax log.
Cleaning Page			Cleans the product when specks or other marks appear on printed output. The cleaning process removes dust and excess toner from the paper path. <p>When selected, the product prompts you to load plain Letter or A4 paper in Tray 1. Touch the OK button to begin the cleaning process. Wait until the process completes. Discard the page that prints.</p>
USB Speed	High*	Full	Sets the USB speed for the USB connection to the computer. For the product to actually operate at high speed, it must have high speed enabled and be connected to an EHCI host controller that is also operating at high speed. This menu item does not reflect the current operating speed of the product.
Less Paper Curl			When printed pages are consistently curled, this option sets the product to a mode that reduces curl.
Archive Print			When printing pages that will be stored for a long time, this option sets the product to a mode that reduces toner smearing and dusting.
Firmware Date Code			Displays the firmware date code.
Restore Defaults			Sets all settings to the factory default values.
Signature Check	Cancel if Invalid		Validates HP firmware downloads.
	Prompt if Invalid		

Table 2-13 Service menu (continued)

Menu item	Sub-menu item	Sub-menu item	Description
LaserJet Update	Check for Updates		Checks for new firmware updates using the network (wired or wireless).
		Manage Updates	Allow Downgrade
		Check Automatically	Enables or disables the function to periodically check for firmware updates. The following options are available: <ul style="list-style-type: none">• On• Off
		Prompt Before Install	When an update is ready, displays a control panel message for confirmation before installing. The following options are available: <ul style="list-style-type: none">• Install Automatically• Always Prompt
		Allow Updates	Enables or disables firmware updates. The following options are available: <ul style="list-style-type: none">• Yes• No

Network Setup menu

In the following table, items that have an asterisk (*) indicate the factory default setting.

Table 2-14 Network Setup menu

Menu item	Sub-menu item	Description
Wireless Menu	Wireless Direct Settings	Manage the product's wireless direct settings.
	Wireless Setup Wizard	Guides you through the steps to set up the product on a wireless network.
	Wi-Fi Protected Setup	If your wireless router supports this feature, use this method to set up the product on a wireless network. This is the simplest method.
	Run Wireless Test	Tests the wireless network and prints a report with the results.
	Turn Wireless On/Off	Enables or disables the wireless network feature.
TCP/IP Config	Automatic*	
	Manual	
IPv4 Config Method	DHCP*	DHCP: The product automatically configures all the TCP/IP settings via DHCP.
	BootP	BootP: The product automatically configures all the TCP/IP settings via BootP.
	Auto IP	Auto IP: The product automatically configures all the TCP/IP settings via Auto IP.
	Manual	Manual: You can manually configure the IP address, subnet mask, and default gateway. The control panel prompts you to specify values for each address section. As each address is completed, the product prompts for address confirmation before moving to the next one. After all three addresses are set, the network reinitializes.
Network Services	IPv4	Enable or disable the IPv4 and IPv6 protocols. By default, each protocol is enabled.
	IPv6	
Link Speed	Automatic*	Sets the link speed manually if needed.
	10T Full	After setting the link speed, the product automatically restarts.
	10T Half	
	100TX Full	
	100TX Half	
Security	Product Security	Set product security options. If enabled, the product prompts you to set a password. After it is set, the password is required to change product settings. The following options are available: <ul style="list-style-type: none"> • On • Off*

Table 2-14 Network Setup menu (continued)

Menu item	Sub-menu item	Description
	HTTPS Enforcement	Sets the product so that it communicates only with Web sites that use hypertext transfer protocol secure (HTTPS). The following options are available: <ul style="list-style-type: none"> • Yes • No*
	Firewall	Enable, disable, or reset the product firewall.
	Access Control List	Enable, disable, or reset the network access control list.
	802.1X	Enable, disable, or reset the 802.1x wireless authentication protocol.
	Reset All Security	Reset the security settings to the factory-set default values.
Restore Defaults		Resets all network configurations to their factory defaults.

Quick Forms menu

Table 2-15 Quick Forms Menu

Menu item	Sub-menu item	Description
Notebook Paper	Narrow Rule	Prints pages that have preprinted lines.
	Wide Rule	
	Child Rule	
Graph Paper	1/8 inch	Prints pages that have preprinted graph lines.
	5 mm	
Checklist	1-Column	Prints pages that have preprinted lines with check boxes.
	2-Column	
Music Paper	Portrait	Prints pages that have preprinted lines for writing music.
	Landscape	

Fax Menu

In the following table, items that have an asterisk (*) indicate the factory default setting.

Table 2-16 Fax Menu

Menu item	Sub-menu item	Sub-menu item	Description
Fax Reports	Fax Confirmation	On Every Fax	Sets whether the product prints a confirmation report after a successful fax job.
		On Send Fax Only	
		On Receive Fax Only	
		Never*	

Table 2-16 Fax Menu (continued)

Menu item	Sub-menu item	Sub-menu item	Description
	Include First Page	On* Off	Sets whether the product includes a thumbnail image of the first page of the fax on the report.
	Fax Error Report	On Every Error* On Send Error On Receive Error Never	Sets whether the product prints a report after a failed fax job.
	Print Last Call Report	On* Off	Prints a detailed report of the last fax operation, either sent or received.
	Fax Activity Log	Print Log Now Auto Log Print	Print Log Now: Prints a list of the faxes that have been sent from or received by this product. Auto Log Print: Automatically prints a report after every fax job.
	Print Phone Book		Prints a list of the speed dials that have been set up for this product.
	Print Junk Fax List		Prints a list of phone numbers that are blocked from sending faxes to this product.
	Print All Fax Reports		Prints all fax-related reports.
Send Options	Send Fax Later	Send Fax time Send Fax date	Allows a fax to be sent at a later time and date.
	Broadcast Fax		Sends a fax to multiple recipients.
	Fax Job Status		Displays pending fax jobs, and allows you to cancel pending fax jobs.
	Fax Resolution	Standard Fine* Superfine Photo	Sets the resolution for sent documents. Higher resolution images have more dots per inch (dpi), so they show more detail. Lower resolution images have fewer dots per inch and show less detail, but the file size is smaller.
Receive Options	Block Junk Faxes	Add Number Delete Number Delete All Numbers Print Junk Fax List	Modifies the junk fax list. The junk fax list can contain up to 30 numbers. When the product receives a call from one of the junk fax numbers, it deletes the incoming fax. It also logs the junk fax in the activity log along with job accounting information.
	Reprint Faxes		Prints the received faxes stored in available memory. This item is available only if you have turned on the Allow Fax Reprint feature in the Fax Setup menu.
	Forward Fax	On Off*	Sets product to send all received faxes to another fax machine.

Table 2-16 Fax Menu (continued)

Menu item	Sub-menu item	Sub-menu item	Description
		Polling Receive	Allows the product to call another fax machine that has polling send enabled.
Phone Book Setup	Individual Setup		Edits the fax phone book speed dial entries.
	Group Setup		Edits the fax phone book groups.
	Delete Entry		Deletes a specific phone book entry.
	Delete All Entries		Deletes all entries in the phone book.
	Print Report		Prints a list of all the individual dial entries in the phone book.
Change Defaults	Fax Setup Utility		Opens the Fax Setup menu.

Copy Menu

To open this menu, touch the [Copy](#) button on the Home screen, and then touch the [Settings](#) button.

In the following table, items that have an asterisk (*) indicate the factory default setting.

Table 2-17 Copy Menu

Menu item	Sub-menu item	Description
Number of Copies		Specifies the number of copies.
Reduce/Enlarge	Original=100%*	Specifies the size of the copy.
	Legal to letter= 77%	
	Legal to A4=82%	
	A4 to Letter=92%	
	Letter to A4=97%	
	Full Page=91%	
	Fit to Page	
	2 Pages per Sheet	
	4 Pages per Sheet	
	Custom: 25 to 400%	
Lighter/Darker		Specifies the contrast of the copy.
Optimize	Auto-select*	Specifies the type of content in the original document, so the copy is the best match for the original.
	Mixed	
	Text	
	Picture	

Table 2-17 Copy Menu (continued)

Menu item	Sub-menu item	Description
Paper	Letter	Specifies the paper size.
	Legal	NOTE: The default paper size setting is determined by the choice of location during the initial product setup.
	A4	
Multi-Page Copy	Off*	When this feature is enabled, the product prompts you to load another page onto the scanner glass or to indicate that the job is complete.
	On	
Tray Select	Tray 1	Specifies which tray to use for copies.
	Tray 2	
	Tray 3	
Two Sided	1 to 1*	Specifies the duplex setting for copies.
	1 to 2	NOTE: This item is available for duplex models only.
	2 to 2	
	2 to 1	
Draft Mode	Off*	Specifies whether to use draft- quality printing for copies.
	On	
Image Adjustment	Lightness	Adjusts the image quality settings for copies.
	Contrast	
	Sharpen	
	Background Removal	
	Color balance	
	Sharpness	
	Grayness	
Collation	On	Specifies whether to collate copy jobs.
	Off*	
Set as New Defaults		Saves any changes you have made to this menu as the new defaults.
Restore Defaults		Restores the factory defaults for this menu.

Tools for troubleshooting: Interpret control panel messages

Control panel message types

- Alert and warning messages appear temporarily and might require you to acknowledge the message by pressing the **OK** button to resume or by pressing the **CANCEL <X>** button to cancel the job. With certain warnings, the job might not complete or the print quality might be affected. If the alert or warning

message is related to printing and the auto-continue feature is on, the product will attempt to resume the printing job after the warning has appeared for 10 seconds without acknowledgement.

- Critical error messages can indicate some kind of failure. Turning off and then turning on the power might fix the problem. If a critical error persists, the product might require service.

The control panel messages indicate the current product status or situations that might require action.

Alert and warning messages appear temporarily and might require you to acknowledge the message by pressing the **OK** button to resume or by pressing the **CANCEL <X>** button to cancel the job. With certain warnings, the job might not complete or the print quality might be affected. If the alert or warning message is related to printing and the auto-continue feature is on, the product will attempt to resume the printing job after the warning has appeared for 10 seconds without acknowledgement.

Critical error messages can indicate some kind of failure. Turning off and then turning on the power might fix the problem. If a critical error persists, the product might require service.



NOTE: Part numbers can change without notice. Always verify part numbers in [HP PartSurfer](#).

Control panel messages

10.100X Supply Memory Error

Description

A specific toner cartridge has a faulty or missing memory chip:

- **10.1000** = black cartridge
- **10.1001** = cyan cartridge
- **10.1002** = magenta cartridge
- **10.1003** = yellow cartridge

Recommended action

1. If non HP toner cartridges are in use, advise the customer to replace the cartridges with HP original supplies. To identify HP original supplies refer to: [HP Color LaserJet and LaserJet Printers - How to Identify HP Original Cartridges](#) (c02603087) (in English) available in Service Access Workbench (SAW) or Channel Service Network (CSN).
2. Check the memory chip. If it is broken or damaged, replace the cartridge.
3. If the error persists, turn the printer off and remove all the toner cartridges. Turn the printer on, then reinstall the cartridges in the correct slots.
4. If the error persists, swap the specific cartridge that the error refers to, with a different color cartridge, to determine whether if the error is caused by the cartridge or the cartridge slot.

For example, insert the yellow cartridge in the magenta slot:

- If a different 10.100X message appears, replace the cartridge that the original message referred to.
- If the same message appears, replace the product.

30.XXXX Scanner Error

Description

The flatbed or ADF scanner is failing to initialize for the following reasons:

- **30.0013** = Scanner failed to find home
- **30.0016** = Scan sensor communication error
- **30.0017** = Scan motor exceeded max position error
- **30.0023** = ADF scanner calibration error

Recommended action

1. Verify that the product has the most recent firmware from hp.com.
2. Run the S2 calibration (especially for 30.0023 errors).

Follow the calibration instructions in this document: [HP LaserJet Pro MFP M425, M476, M521 and M570 - Control panel error: "The product is unable to calibrate" and/or vertical streaks on back side of duplex scan or copy](#) (c03799079) (in English) available in Service Access Workbench (SAW) or Channel Service Network (CSN).

3. Verify that the (flat flexible cables (FFC's) are seated correctly on the formatter board.
4. If the error persists, replace the Scanner/ADF Assembly (HP Part #: CF387-60106).
5. If the error persists, escalate to Level 3 so that Technical Marketing has visibility to the problem.

49 Error, Turn off then on

Description

The product has experienced an internal embedded software error. Under most conditions, the product automatically restarts.

Recommended action

1. Reset the printer:
 - a. Turn off the power by using the power switch, and then wait at least 30 seconds.
 - b. Turn on the power and wait for the product to initialize.
2. If you are using a surge protector:
 - a. Power off the printer.
 - b. Remove the surge protector.
 - c. Plug the product directly into the wall socket and turn the product power on.
3. If the error persists, disconnect any network or USB cables and power cycle. If the product returns to Ready, check the FW version and update if a newer version is available.
4. If the error persists, print a [Service Page](#) from the [Reports](#) menu. Also, print an [Error Report](#) from the [2ndary Service Menu](#).

On the Service Page, look at the xxxx portion of the 49.xxxx errors listed:

- If the numbers are all or mostly different, then power quality is a possible problem; try a different wall socket.
 - If the xxxx portion of 49.xxxx contain repeats of the same numbers or groups of numbers, then check the 2ndary Service Error Report printed earlier for indications of a failure in a particular area. The report may indicate whether the error is caused by a network problem or a problem with the job.
5. If the error persists, replace the product.



NOTE: If the 49 Error is caused by the network or a specific file, do not replace the product; it will not resolve the issue. Instead, attempt to isolate the issue in a way that demonstrates the error is caused by something in the environment.

6. If the error persists after product replacement, escalate to Level 3 so that Technical Marketing has visibility to the problem.

50.XXXX Fuser Error

Description

The product has experienced an internal fuser hardware error:

- **50.0000** = Generic Fuser error
- **50.1000** = Low Fuser temperature error
- **50.1100** = High sub thermistor area 3 fuser error
- **50.1200** = Low sub thermistor area 3 fuser error
- **50.2000** = Slow fuser error
- **50.3000** = High fuser temperature error
- **50.4000** = Fuser drive circuit error
- **50.7000** = Fuser open error
- **50.8000** = Low sub thermistor fuser error
- **50.9000** = High sub thermistor fuser error

Recommended action

1. Reset the printer:
 - a. Turn off the power by using the power switch, and then wait at least 30 seconds.
 - b. Turn on the power and wait for the product to initialize.
2. If you are using a surge protector:
 - a. Power off the printer.
 - b. Remove the surge protector.
 - c. Plug the product directly into the wall socket and turn the product power on.
3. If the error persists, replace the Fusing Assembly:

- Fusing assembly - For 110 VAC, (HP Part #: RM2-5476-000CN).
 - Fusing assembly - For 220 VAC, (HP Part #: RM2-5478-000CN).
4. If the error persists, replace the product.

51.XX and 52.XX Error To continue turn off then on

Description

An error with the laser/scanner assembly has occurred in the product.

XX = 00-23: Laser Scanner malfunction

Recommended action

1. Reset the printer:
 - a. Turn off the power by using the power switch, and then wait at least 30 seconds.
 - b. Turn on the power and wait for the product to initialize.
2. If you are using a surge protector:
 - a. Power off the printer.
 - b. Remove the surge protector.
 - c. Plug the product directly into the wall socket and turn the product power on.
3. If the error persists, replace the product.

54.0100 — 54.1599 Error

Description

The Color Plane Registration Sensor has experienced an error.

Recommended action

1. Reset the printer:
 - a. Turn off the power by using the power switch, and then wait at least 30 seconds.
 - b. Turn on the power and wait for the product to initialize.
2. If you are using a surge protector:
 - a. Power off the printer.
 - b. Remove the surge protector.
 - c. Plug the product directly into the wall socket and turn the product power on.
3. Reseat sensor connections on the DC Controller.
4. If the error persists, replace the Color Plane Registration Sensor Assembly (HP Part #: RM1-8029-000CN).
5. If the error persists, replace the product.

55.1 DC controller Memory Error

Description

The DC controller experienced a communication error.

Recommended action

1. Reset the printer:
 - a. Turn off the power by using the power switch, and then wait at least 30 seconds.
 - b. Turn on the power and wait for the product to initialize.
2. If you are using a surge protector:
 - a. Power off the printer.
 - b. Remove the surge protector.
 - c. Plug the product directly into the wall socket and turn the product power on.
3. If the error persists, replace the DC controller PC Board Assembly (HP Part #: RM2-8028-000CN).

57 Fan Error, Turn off then on

Description

The product has experienced a problem with its internal cooling fan.

Recommended action

1. Reset the printer:
 - a. Turn off the power by using the power switch, and then wait at least 30 seconds.
 - b. Turn on the power and wait for the product to initialize.
2. If you are using a surge protector:
 - a. Power off the printer.
 - b. Remove the surge protector.
 - c. Plug the product directly into the wall socket and turn the product power on.
3. If the error persists, replace the internal cooling fan (HP Part #: RK2-3847-000CN).

58.04 Error Turn off then on

Description

The low voltage power supply has experienced an error.

Recommended action

1. Reset the printer:

- a. Turn off the power by using the power switch, and then wait at least 30 seconds.
 - b. Turn on the power and wait for the product to initialize.
2. If you are using a surge protector:
- a. Power off the printer.
 - b. Remove the surge protector.
 - c. Plug the product directly into the wall socket and turn the product power on.
3. Check the voltage label on the back of the product. If the product is rated 220V and is plugged into a 110V outlet, this error might occur. In most cases, no damage is caused to the product.
- If a power transformer is used to convert 220V power to 110V, verify that the transformer power rating is sufficient to operate the product.
4. If the error persists, replace the Low Voltage Power Supply:
- Low voltage power supply PC board assembly - Input voltage 110VAC-127VAC, (HP Part #: RM2-8030-000CN).
 - Low voltage power supply PC board assembly - Input voltage 220VAC-240VAC, (HP Part #: RM2-8032-000CN).

59.XXXX Error Turn off then on

Description

The product has experienced an internal motor error:

- **59.3XXX** = Feed motor start error
- **59.4XXX** = Feed motor rotation error
- **59.8000** = Drum motor start error
- **59.9000** = Developer motor start error

Recommended action

1. Reset the printer:
 - a. Turn off the power by using the power switch, and then wait at least 30 seconds.
 - b. Turn on the power and wait for the product to initialize.
2. If you are using a surge protector:
 - a. Power off the printer.
 - b. Remove the surge protector.
 - c. Plug the product directly into the wall socket and turn the product power on.
3. If the error persists, replace the appropriate motor depending on the error code:

- For **59.3XXX** and **59.4XXX** errors replace the Feed Motor Assy (HP Part #: RM1-5419-000CN).
 - For **59.8000** errors replace the Drum Motor, DC (HP Part #:RL1-1800-000CN).
 - For **59.9000** errors the Developer Motor, DC (HP Part #: RL1-3053-000CN).
4. If the error persists, replace the Driver PCA Assembly (HP Part #: RM1-8032-000CN).
 5. If the error persists, replace the DC controller (HP Part #: RM2-8028-000CN).
 6. If the error persists, replace the product.

60.XXXX Error Turn off then on

Description

One of the trays has experienced a tray lift error:

- **60.0200** = Tray 2 lift error
- **60.0300** = Tray 3 lift error

Recommended action

1. Reset the printer:
 - a. Turn off the power by using the power switch, and then wait at least 30 seconds.
 - b. Turn on the power and wait for the product to initialize.
2. If you are using a surge protector:
 - a. Power off the printer.
 - b. Remove the surge protector.
 - c. Plug the product directly into the wall socket and turn the product power on.
3. If the error persists, replace parts as follows:
 - For **60.0200** error, replace the Tray 2 Paper Cassette (HP Part #: RM2-5469-000CN).
 - For **60.0300** error, replace the 3rd Paper Tray Main Body (HP Part #: CE863-67901).
4. If the **60.0200** error persists, replace the Paper Pick-up Assembly (HP Part #: RM1-8045-000CN).

79 Error Turn off then on

Description

The product has experienced an internal firmware error. Under most conditions, the product automatically restarts.

Recommended action

1. Reset the printer:
 - a. Turn off the power by using the power switch, and then wait at least 30 seconds.
 - b. Turn on the power and wait for the product to initialize.
2. If you are using a surge protector:

- a. Power off the printer.
 - b. Remove the surge protector.
 - c. Plug the product directly into the wall socket and turn the product power on.
3. If the error is intermittent, attempt to isolate the issue to something specific in the customers environment.



NOTE: If the 79 Error is caused by the network or a specific file, do not replace the formatter; it will not resolve the issue. Instead, attempt to isolate the issue in a way that demonstrates the error is caused by something in the environment.

4. If the error is persistent, replace the Formatter PCA:
 - Formatter PCA M476 nw (HP Part #: CF385-60001).
 - Formatter PCA M476 dn (HP Part #: CF386-60002).
 - Formatter PCA M476 dw (HP Part #: CF387-60004).
 - Formatter PCA M476 nw CHINA ONLY (HP Part #: CF385-60002).
 - Formatter PCA M476 dn CHINA ONLY (HP Part #: CF386-60003).
 - Formatter PCA M476 dw CHINA ONLY (HP Part #: CF387-60005).

Device is busy. Try again later.

Description

The product is currently in use.

Recommended action

1. Wait for the product to finish the current job, or to finish initializing.
2. Turn the product off, then on, to see whether it comes to a **Ready** state.
3. Restore the device to the factory default settings. ([Setup Menu](#) -> [Service Menu](#) -> [Restore Defaults](#))
4. If the issue persists, upgrade to the latest firmware version.

Document feeder mispick. Reload.

Description

The product did not pick up the paper in the document feeder.

Recommended action

1. Remove the paper from the document feeder tray, and then reload it.
2. Verify there are no staples or paper clips on the stack of originals. Verify the originals are straightened out from previous folds or curl.
3. If the control panel displays **Document Feeder Loaded** when the originals are not in the input tray of the document feeder, the sensor on the document feeder might be malfunctioning. Replace the Scanner/ADF Assembly (HP Part #: CF387-60106).

Document feeder jam. Clear and reload.

Description

Paper is jammed in the document feeder tray or a sensor has incorrectly detected media in the document feeder paper path.

Recommended action

1. Remove the paper from the document feeder. If the paper rips, use a thick piece of paper (such as a business card) to clean the paper path.
2. Reset the printer:
 - a. Turn off the power by using the power switch, and then wait at least 30 seconds.
 - b. Turn on the power and wait for the product to initialize.
3. If the error persists, replace the Scanner/ADF Assembly (HP Part #: CF387-60106).

Fax is busy. Canceled send.

Description

The fax line to which you were sending a fax was busy. The product has canceled sending the fax.

Recommended action

1. Call the recipient to ensure that the fax machine is on and ready.
2. Verify that the fax number is correct.
3. Verify that the [Redial if Busy](#) option is enabled.
4. Open the [Service](#) menu, and then touch the [Fax Service](#) button. Touch the [Run Fax Test](#) button. This test verifies that the phone cord is connected to the correct port and that the phone line has a signal. The product prints a report with the results.
5. For more information about troubleshooting problems with sending or receiving faxes, see [HP LaserJet Pro MFP M425, MFP M351/M451, MFP M375/M475, M476, MFP M521 and MFP M570 - Solve problems sending or receiving faxes \(includes fax error messages\)\(c03491494\)](#) (in English) available in Service Access Workbench (SAW) or Channel Service Network (CSN).

Fax receive error.

Description

An error occurred while trying to receive a fax.

Recommended action

1. Ask the sender to resend the fax.
2. To verify that the telephone cord is securely connected, disconnect and reconnect the telephone cord.
3. Verify that you are using the telephone cord that came with the product.
4. Open the [Service](#) menu, and touch the [Fax Service](#) button. Touch the [Run Fax Test](#) button. This test verifies that the phone cord is connected to the correct port and that the phone line has a signal. The product prints a report with the results.

5. Decrease the fax speed. Ask the sender to resend the fax.
6. Turn off error-correction mode. Ask the sender to resend the fax.



NOTE: Turning off error-correction mode might reduce the quality of the fax image.

7. Connect the product to a different phone line.
8. For more information about troubleshooting problems with sending or receiving faxes, see [HP LaserJet Pro MFP M425, MFP M351/M451, MFP M375/M475, M476, MFP M521 and MFP M570 - Solve problems sending or receiving faxes \(includes fax error messages\)](#) (c03491494) (in English) available in Service Access Workbench (SAW) or Channel Service Network (CSN).

Additional fax sending/receiving troubleshooting can be found in this document: [HP LaserJet Pro MFP M425, MFP M351/M451, MFP M375/M475, M476, MFP M521 and MFP M570 - Solve problems sending or receiving faxes \(includes fax error messages\)](#)(c03491494) (in English) available in Service Access Workbench (SAW) or Channel Service Network (CSN).

Fax Send error.

Description

An error occurred while trying to send a fax.

Recommended action

1. Resend the fax.
2. Try faxing to another fax number.
3. To verify that the telephone cord is securely connected, disconnect and reconnect the telephone cord.
Check that the telephone cord is securely connected by unplugging and replugging the cord.
4. Verify that you are using the telephone cord that came with the product.
5. Open the [Service](#) menu, and touch the [Fax Service](#) button. Touch the [Run Fax Test](#) button. This test verifies that the phone cord is connected to the correct port and that the phone line has a signal. The product prints a report with the results.
6. Connect the product to a different phone line.
7. Set the fax resolution to [Standard](#) instead of the default of [Fine](#) .
8. For more information about troubleshooting problems with sending or receiving faxes, see [HP LaserJet Pro MFP M425, MFP M351/M451, MFP M375/M475, M476, MFP M521 and MFP M570 - Solve problems sending or receiving faxes \(includes fax error messages\)](#) (c03491494) (in English) available in Service Access Workbench (SAW) or Channel Service Network (CSN).

Additional fax sending/receiving troubleshooting can be found in this document: [HP LaserJet Pro MFP M425, MFP M351/M451, MFP M375/M475, M476, MFP M521 and MFP M570 - Solve problems sending or receiving faxes \(includes fax error messages\)](#)(c03491494) (in English) available in Service Access Workbench (SAW) or Channel Service Network (CSN).

Fax storage is full. Canceling the fax send/receive.

Description

The amount of available memory for storing faxes is insufficient to store an incoming fax.

Recommended action

1. If you are using the [Private Receive](#) feature, print all received faxes to regain some memory.
2. If the issue persists, clear faxes from memory:
 - a. Open the [Service](#) menu.
 - b. Touch the [Fax Service](#) button.
 - c. Touch the [Clear Saved Faxes](#) menu item.

Front door open.**Description**

The toner cartridge door is open.

Recommended action

1. Close the toner cartridge door.
2. If the issue persists, open the toner cartridge door and locate the door open switch in the upper right hand corner of the opening. Manually activate the switch:
 - a. If the **Front door open** message disappears, check for a broken flag on the corresponding part of the front door assembly. If the flag is broken replace the front door assembly (HP Part #: RM2-5301-000CN).
 - b. If manually activating the switch does not clear the message, replace the product. (The door switch is not an orderable part.)

Jam in Tray 1, Clear jam and then press OK**Description**

The product has detected a jam in Tray 1.

Recommended action

1. Clear the jam from the area indicated on the product control panel, and then follow the control panel instructions.
2. Make sure the paper guides in the tray are adjusted correctly for the size of paper.
3. If the jam persists, replace the Tray 1 pick-up roller (HP Part #: RL1-1802-000CN).

Jam in Tray 2, Clear jam and then press OK**Description**

The product has detected a jam in Tray 2.

Recommended action

1. Clear the jam from the area indicated on the product control panel, and then follow the control panel instructions.
2. Make sure the paper guides in the tray are adjusted correctly for the size of paper.
3. If the jam persists, replace the Tray 2 pick-up roller (HP Part #: RM1-8047-000CN).

Jam in Tray 3, Clear jam and then press OK

Description

The product has detected a jam in Tray 3.

Recommended action

1. Clear the jam from the area indicated on the product control panel, and then follow the control panel instructions.
2. Make sure the paper guides in the tray are adjusted correctly for the size of paper.
3. If the jam persists, replace the Tray 3 pick-up roller (HP Part #: RM1-8047-000CN).

Load paper

Description

The tray is empty.

Recommended action

Load paper in the tray.

Load Tray 1 <TYPE> <SIZE>, Press OK to use available media

Description

Device is processing a job, but no trays match.

Recommended action

1. Load paper in the correct orientation.
2. Touch the OK button to use existing tray settings.

Load Tray 1, <PLAIN> <SIZE> / Cleaning mode, OK to start

Description

Cleaning mode paper prompt.

Recommended action

Load a clean sheet of paper in the correct orientation, then touch the OK button to begin the cleaning procedures.

Load tray <X> Press [OK] for available media

Description

The tray is empty.

Recommended action

Load paper into the tray to continue printing. Press the OK button to select a different tray.

No dial tone.

Description

The product could not detect a dial tone.

Recommended action

1. Check for a dial tone on the phone line by touching the [Start Fax](#) button.
2. Unplug the telephone cord from both the product and the wall and replug the cord.
3. Verify that you are using the telephone cord that came with the product.
4. Open the [Service](#) menu, and touch the [Fax Service](#) button. Touch the [Run Fax Test](#) button. This test verifies that the phone cord is connected to the correct port and that the phone line has a signal. The product prints a report with the results.
5. For more information about troubleshooting problems with sending or receiving faxes, see [HP LaserJet Pro MFP M425, MFP M351/M451, MFP M375/M475, M476, MFP M521 and MFP M570 - Solve problems sending or receiving faxes \(includes fax error messages\)](#) (c03491494) (in English) available in Service Access Workbench (SAW) or Channel Service Network (CSN).

Additional fax sending/receiving troubleshooting can be found in this document: [HP LaserJet Pro MFP M425, MFP M351/M451, MFP M375/M475, M476, MFP M521 and MFP M570 - Solve problems sending or receiving faxes \(includes fax error messages\)](#)(c03491494) (in English) available in Service Access Workbench (SAW) or Channel Service Network (CSN).

No fax detected.

Description

The product answered the incoming call but did not detect that a fax machine was calling.

Recommended action

1. Open the [Service](#) menu, and touch the [Fax Service](#) button. Touch the [Run Fax Test](#) button. This test verifies that the phone cord is connected to the correct port and that the phone line has a signal. The product prints a report with the results.
2. For more information about troubleshooting problems with sending or receiving faxes, see [HP LaserJet Pro MFP M425, MFP M351/M451, MFP M375/M475, M476, MFP M521 and MFP M570 - Solve problems sending or receiving faxes \(includes fax error messages\)](#) (c03491494) (in English) available in Service Access Workbench (SAW) or Channel Service Network (CSN).

Additional fax sending/receiving troubleshooting can be found in this document: [HP LaserJet Pro MFP M425, MFP M351/M451, MFP M375/M475, M476, MFP M521 and MFP M570 - Solve problems sending or receiving faxes \(includes fax error messages\)](#)(c03491494) (in English) available in Service Access Workbench (SAW) or Channel Service Network (CSN).

The product is unable to calibrate. Close the lid and remove paper from the document feeder.

Description

The default calibration values for the ADF side 2 scan head are failing to help the unit initialize.

Recommended action

1. Follow the calibration instructions in this document: [HP LaserJet Pro MFP M425, M476, M521 and M570 - Control panel error: "The product is unable to calibrate" and/or vertical streaks on back side of duplex scan or copy \(c03799079\)](#) (in English) available in Service Access Workbench (SAW) or Channel Service Network (CSN).
2. If the error persists, replace the scanner/ADF Assembly (HP Part #: CF387-60106).
3. If the error persists after part replacement, escalate the customer to Level 3 so that Technical Marketing has visibility to the problem.

Unexpected size in tray # Load <size> Press [OK]

Description

The product has detected paper in the tray that does not match the configuration for the tray.





Recommended action

Load the correct paper into the tray, or configure the tray for the size that you have loaded.

Tools for troubleshooting: Event-log messages

The following table contains all the event log codes for this product. Many event log codes correspond to a control panel error message.

Print the event log

1. Make sure the product is in the Ready state.
2. Touch the **Setup**  button.
3. Simultaneously touch the **Left Arrow**  button and the **Cancel**  button.
4. Touch the **Setup**  button.
5. Open the **Secondary Service** menu.
6. Open the **Service Reports** menu.
7. Touch the **Error Report** item.

Event log messages

The following table contains all event log codes for this product. Many event log codes correspond to a control-panel error message.

Some product events do not produce a message that displays on the control panel. Instead, they are only recorded in the event log.

Table 2-18 Event-log messages

Event code	Description
13.0000	Paper jam
41.3000	Unexpected size

Table 2-18 Event-log messages (continued)

Event code	Description
50.1000	Low fuser temperature error
50.2000	Slow fuser error
50.3000	High fuser temperature error
50.4000	Fuser drive circuit error
50.7000	Fuser open error
50.8000	Low sub-thermistor fuser error
50.9000	High sub-thermistor fuser error
51.2000	Black scanner laser error (inline devices only)
51.2100	Cyan scanner laser error (inline devices only)
51.2200	Magenta scanner laser error (inline devices only)
51.2300	Yellow scanner laser error (inline devices only)
54.0100	Environmental sensor error
54.0600	Density sensor error
54.1100	Black density out of range
54.1101	Cyan density out of range
54.1102	Magenta density out of range
54.1103	Yellow density out of range
54.1200	Black density measurement abnormality
54.1201	Cyan density measurement abnormality
54.1202	Magenta density measurement abnormality
54.1203	Yellow density measurement abnormality
54.1400	Color plane registration sensor error (inline devices only)
54.1599	Black CPR pattern cannot be read
54.1501	Cyan CPR pattern cannot be read
54.1502	Magenta CPR pattern cannot be read
54.1503	Yellow CPR pattern cannot be read
54.1500	Yellow toner level sensor error
54.1600	Magenta toner level sensor error
54.1700	Cyan toner level sensor error
54.1800	Black toner level sensor error
54.1900	Bad top-of-page (TOP) sensor
54.2100	Beam detect (BD) error
54.2500	Top-of-page sensor error

Table 2-18 Event-log messages (continued)

Event code	Description
55.0000	Engine internal communication error
55.0601	DC controller NVRAM data error
55.0602	DC controller NVRAM access error
55.1000	DC controller memory error
57.0100	Fan motor error
57.0200	Fan error
59.0160	ITB or main motor rotation error (59.A0)
59.0192	Developer motor rotation error (59.C0)
59.0240	Transfer alienation failure (59.F0)
59.3000	Fuser motor startup error
59.4000	Fuser motor error

Table 2-19 Event-log-only messages

Event code	Description
54.2100	Beam detect (BD) error
54.2500	Top-of-page sensor error
55.4000	Engine time out warning
55.9028	DCC NVRAM restore

Clear jams

Jam locations

Use this illustration to identify locations of jams. In addition, instructions display on the control panel to direct you to the location of jammed paper and how to clear it.



NOTE: Internal areas of the product that might need to be opened to clear jams have green handles or green labels.



1	Document feeder
2	Duplexer
3	Output bin
4	Tray 1
5	Tray 2
6	Tray 3

Loose toner might remain in the product after a jam. This problem typically resolves itself after a few sheets have been printed.

Experiencing frequent or recurring paper jams?

To reduce the number of paper jams, try these solutions.

1. Use only paper that meets HP specifications for this product.
2. Use paper that is not wrinkled, folded, or damaged. If necessary, use paper from a different package.
3. Use paper that has not previously been printed or copied on.
4. Make sure the tray is not overfilled. If it is, remove the entire stack of paper from the tray, straighten the stack, and then return some of the paper to the tray.
5. Make sure the paper guides in the tray are adjusted correctly for the size of paper. Adjust the guides so they are touching the paper stack without bending it.

6. Make sure that the tray is fully inserted in the product.
7. If you are printing on heavy, embossed, or perforated paper, use the manual feed feature and feed sheets one at a time.
8. From the Home screen on the product control panel, scroll to and touch the **Trays** button. Verify that the tray is configured correctly for the paper type and size.
9. Make sure the printing environment is within recommended specifications.

Clear jams in the document feeder

1. Open the document-feeder cover.



2. Gently pull the jammed paper out.



3. Close the document-feeder cover.

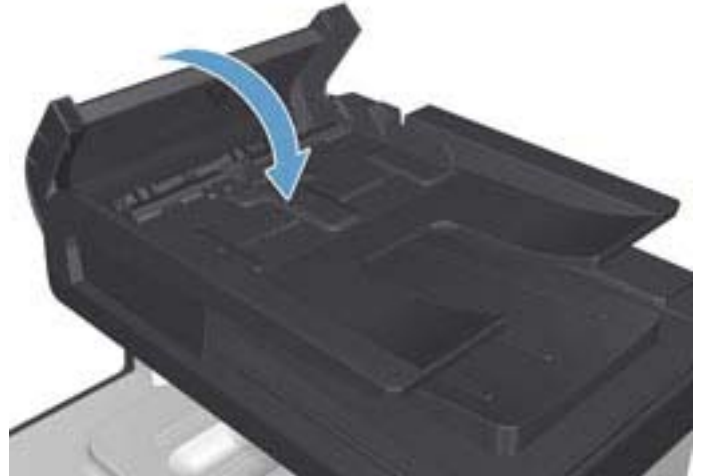

4. Open the scanner lid. If paper is jammed in the scanner lid, gently pull it out.



Clear jams in Tray 1

1. Pull the jammed sheet from tray 1.

NOTE: If the sheet tears, make sure that all of the fragments are removed before you resume printing.

If most of the sheet of paper has been pulled inside the product or no paper is visible, continue with the following steps.

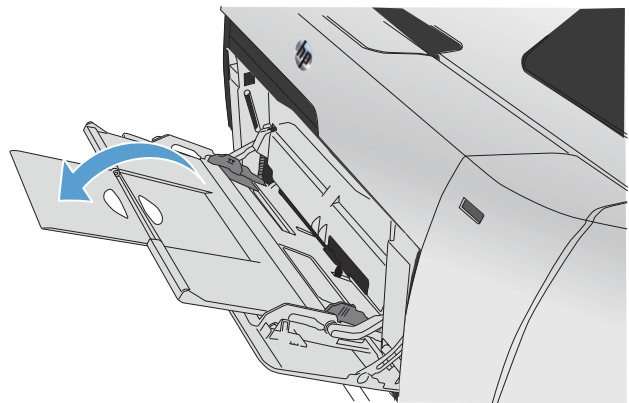

2. Pull out tray 2 and place it on a flat surface.

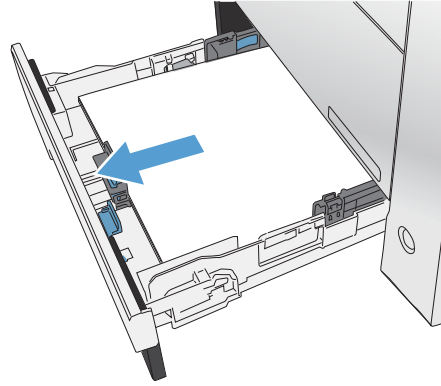

3. Lower the jam-access tray.

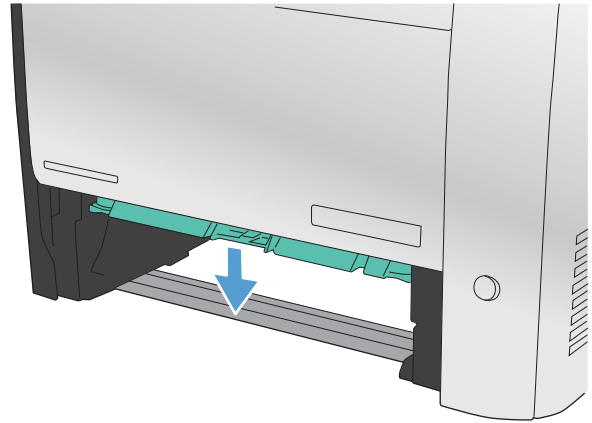

4. Remove the jammed sheet by pulling it straight out.

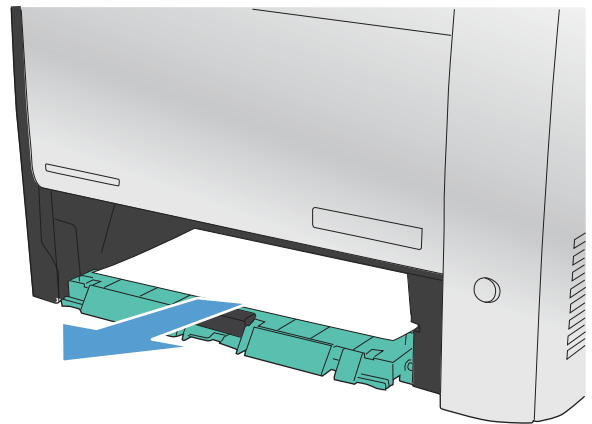

5. Push the jam-access tray up to close it and then replace tray 2.

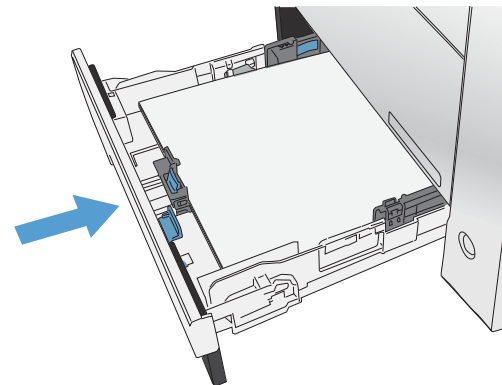



NOTE: To close the tray, push in the middle or with even pressure on both sides. Avoid pushing on one side only.

Clear jams in Tray 2

1. Open tray 2.

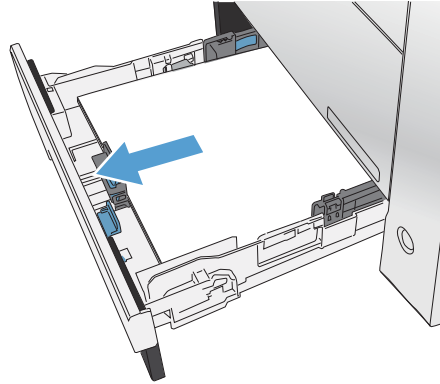

2. Remove the jammed sheet by pulling it straight out.

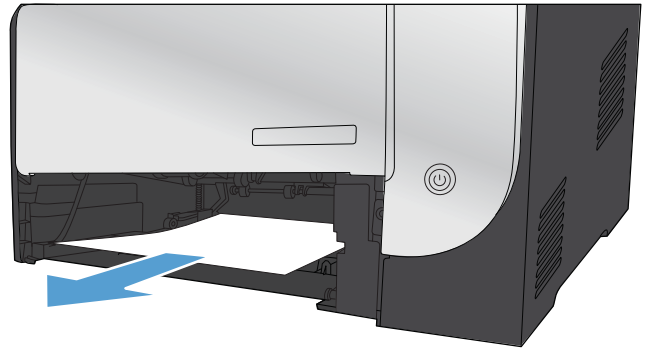

3. Close tray 2.

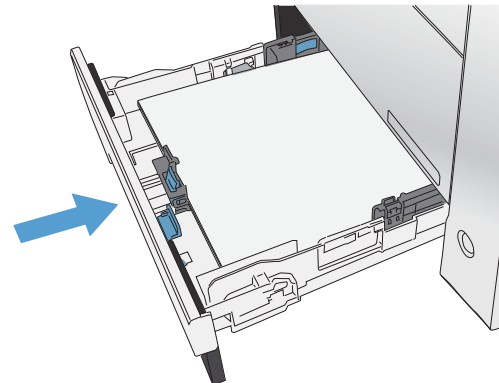

Clear jams in Tray 3 (accessory)

1. Open tray 3.



2. Remove the jammed sheet by pulling it out.



3. Close tray 3.



4. Open the rear door.

CAUTION: The fuser, located in the back of the product, is hot. Wait for the fuser to cool before continuing.

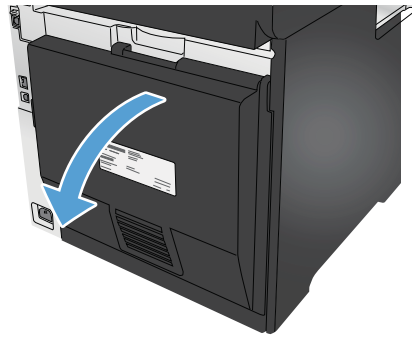

5. Remove any visible paper from the product.

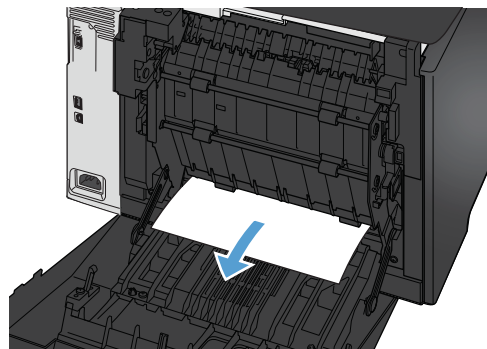

6. Close the rear door.

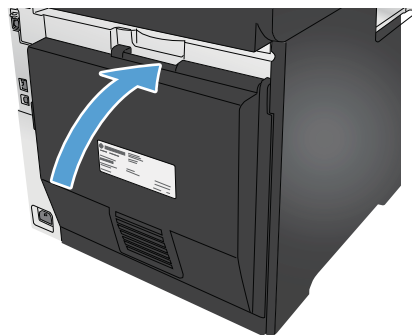

Clear jams in the duplexer

1. Open the rear door.

CAUTION: The fuser, located in the back of the product, is hot. Wait for the fuser to cool before continuing.

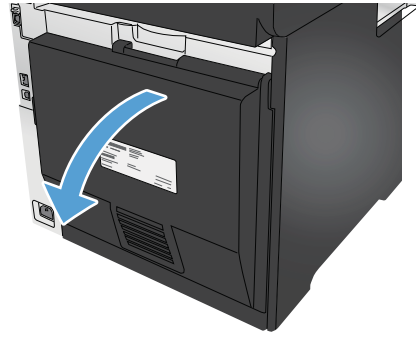

2. If necessary, pull the guide (1) and remove any visible paper (2) from the bottom of the delivery area.

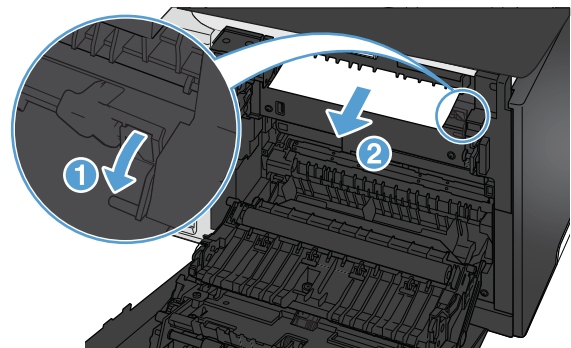

3. If necessary, remove any visible paper from bottom side of the duplexing unit.

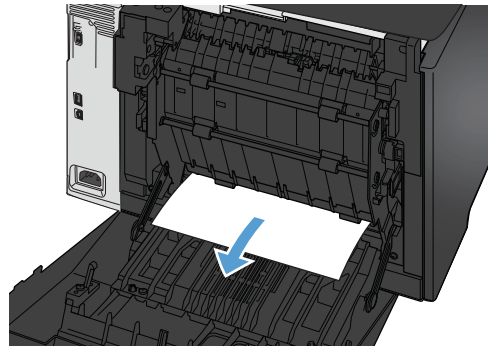

- 4. If you can not see any jammed paper, lift the duplexing unit using the tab on the side of the duplexing unit.

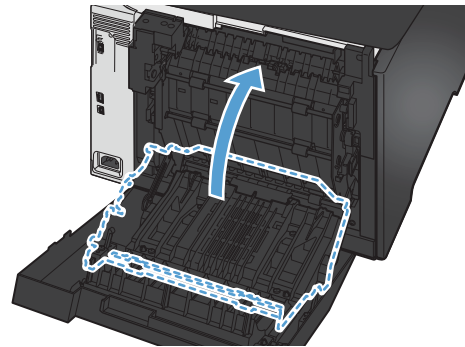

- 5. If you can see the trailing edge of the paper, remove the paper from the product.

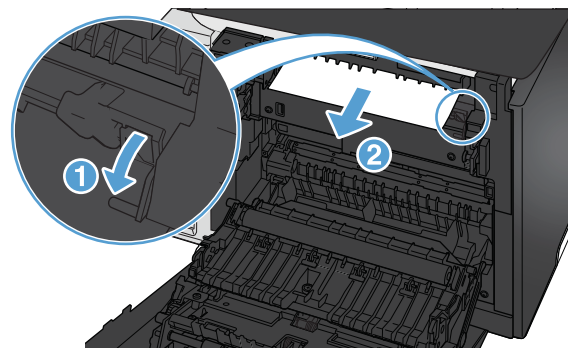

- 6. If you can see the leading edge of the paper, remove it from the product.

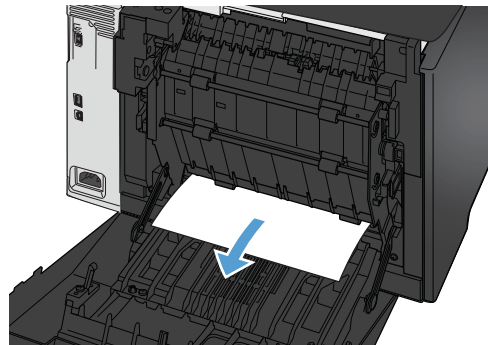

- 7. Close the rear door.

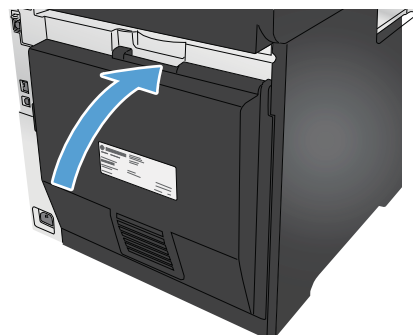

Clear jams in the output bin

1. If paper is visible in the output bin, grasp the leading edge with both hands and slowly remove it.



2. Open the rear door to check for jammed paper.

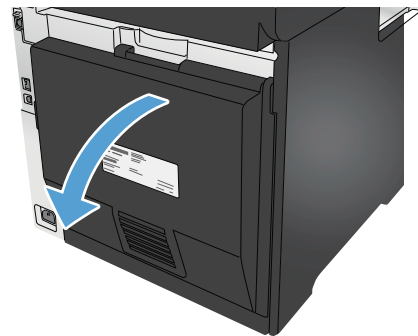

3. Remove any jammed paper. Use both hands to pull out the paper to avoid tearing.
4. Close the rear door.

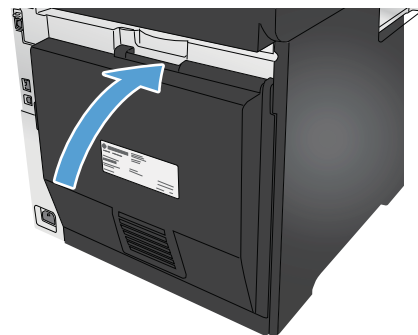

Paper feeds incorrectly or becomes jammed

The product does not pick up paper

If the product does not pick up paper from the tray, try these solutions.

1. Open the product and remove any jammed sheets of paper.
2. Load the tray with the correct size of paper for your job.
3. Make sure the paper size and type are set correctly on the product control panel.
4. Make sure the paper guides in the tray are adjusted correctly for the size of paper. Adjust the guides to the appropriate indentation in the tray.
5. Check the product control panel to see if the product is waiting for you to acknowledge a prompt to feed the paper manually. Load paper, and continue.
6. The pickup roller and separation pad might be contaminated.

The product picks up multiple sheets of paper

If the product picks up multiple sheets of paper from the tray, try these solutions.

1. Remove the stack of paper from the tray and flex it, rotate it 180 degrees, and flip it over. *Do not fan the paper.* Return the stack of paper to the tray.
2. Use only paper that meets HP specifications for this product.
3. Use paper that is not wrinkled, folded, or damaged. If necessary, use paper from a different package.
4. Make sure the tray is not overfilled. If it is, remove the entire stack of paper from the tray, straighten the stack, and then return some of the paper to the tray.
5. Make sure the paper guides in the tray are adjusted correctly for the size of paper. Adjust the guides to the appropriate indentation in the tray.
6. Make sure the printing environment is within recommended specifications.
7. If the multi-feed occurred when pulling paper from Tray 1, you can try loading the paper into Tray 2. The paper feed angle is reduced when printing from Tray 2.

Solve image-quality problems

Solve image quality problems: Image defects table

The following examples depict letter-size paper that has passed through the product short-edge first. These examples illustrate problems that would affect all the pages that you print, whether you print in color or in black only.

Table 2-20 Image defects table





Problem	Sample	Cause	Solution
Print is light or faded on entire page.		Poor contacts exist on the ITB unit and the product grounding unit.	Clean the grounding contacts. If the problem remains after cleaning, check the contacts for damage. Replace any deformed or damaged parts.
		Poor secondary transfer contacts exist on the secondary transfer roller and the ITB.	Clean the contacts. If the problem remains after cleaning, check the contacts for damage. Replace any deformed or damaged parts.
Print is light or faded in a particular color.		Poor primary transfer bias contacts on the ITB unit and product.	Clean the contacts of the color that produces the light print. If the problem remains after cleaning, check the contacts for damage. Replace any deformed or damaged parts.
		Poor primary charging bias contacts with the toner cartridge and product.	
		Poor developing bias contacts with the toner cartridge and product.	
Image is too dark.		The RD sensor is defective.	Replace the RD sensor.
Page is blank.		The high-voltage power-supply lower is defective (no developing bias output).	Replace the high-voltage power-supply lower.

Table 2-20 Image defects table (continued)



Problem	Sample	Cause	Solution
The page is all black or a solid color.		Poor contact exists in the primary charging bias or developing bias contacts between the toner cartridge and the product.	Clean each contact of the color that produces the all black or solid color. If the problem remains after cleaning, check the contacts for damage. Replace any deformed or damaged parts. Replace the affected toner cartridge.
A color is missing from the image.		The toner cartridge might not be seated properly.	Open the toner cartridge drawer and re-seat the toner cartridge.
White spots appear in an image		<p>The primary transfer roller is deformed or has deteriorated.</p> <p>The secondary transfer roller is deformed or has deteriorated.</p>	<p>Replace the ITB.</p> <p>Replace the secondary-transfer-roller.</p>
The back of the page is dirty.		<p>The secondary transfer roller is dirty.</p> <p>The fuser inlet guide or separation guide is dirty.</p> <p>The pressure roller is dirty.</p>	<p>Replace the secondary transfer roller.</p> <p>Clean the dirty parts. If the dirt does not come off, replace the guide.</p> <p>Run the cleaning page several times. If the issue persists, replace the fuser.</p>

Table 2-20 Image defects table (continued)



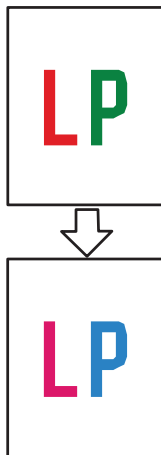
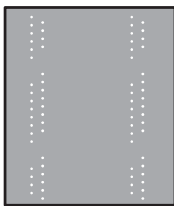

Problem	Sample	Cause	Solution
Vertical streaks or bands appear on the page.		Scratches are present on the circumference of the photosensitive drum.	Replace the toner cartridge of the color that matches the defect.
		Scratches are present on the circumference of the fuser roller.	Replace the fuser.
		Scratches are present on the circumference of the ITB.	Replace the ITB.
		The ITB drive roller is deformed or has deteriorated. The ITB cleaning mechanism is malfunctioning.	
Vertical white lines appear in a particular color.		The laser beam window is dirty.	Clean the window and remove any foreign substances.
		Scratches are present on the circumference of the developing cylinder or photosensitive drum.	Remove the affected toner cartridge and re-install it. The PGCs will clean the glass. If the problem persists, replace the affected toner cartridge.
		White scratch down the page could mean the scanner glass needs to be cleaned.	
		The laser/scanner-unit mirror is dirty.	Replace the laser/scanner assembly.
Vertical white lines appear in all colors.		Horizontal scratches on the fuser roller.	Replace the fuser.
		Scratches are present on the circumference of the ITB.	Remove the affected toner cartridge and re-install it. The PGCs will clean the glass.
		White scratch down the page could mean the scanner glass needs to be cleaned.	Replace the ITB.
Horizontal lines appear on the page.		Repetitive horizontal lines appear.	Use the repetitive defects ruler to identify the dirty roller. Clean the roller. If the roller cannot be cleaned, replace the fuser.
		Horizontal scratches are present on the photosensitive drum.	Replace the toner cartridge of the color that matches the defect.
		Horizontal scratches are present on the fuser roller.	Replace the fuser.

Table 2-20 Image defects table (continued)

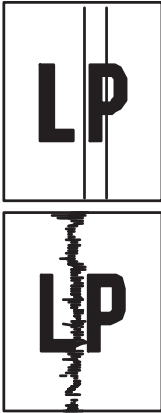

Problem	Sample	Cause	Solution
A horizontal white line displays on the page.		Repetitive horizontal white lines appear.	Use the repetitive defects ruler to identify the dirty roller. Clean the roller. If the roller cannot be cleaned, replace the roller.
		Horizontal scratches are present on the photosensitive drum.	Replace the toner cartridge of the color that matches the defect.
		Scratches are present on the circumference of the ITB.	Replace the ITB.
Image in a particular color does not print in the correct color.		Poor contact exists in the primary charging bias or developing bias contacts between the toner cartridge and the product.	Clean each contact of the color that produces the missing color. If the problem remains after cleaning, check the contacts for damage. Replace any deformed or damaged parts.
		The toner cartridge (primary charging roller, developing roller, or photosensitive drum) is defective.	Replace the toner cartridge of the color that matches the defect.
		The high-voltage power-supply lower is defective (no primary charging bias or developing bias output).	Replace the high-voltage power-supply lower.
		The laser/scanner unit is defective.	Replace the laser/scanner assembly.
Dropouts appear.		The secondary transfer roller is deformed or has deteriorated.	Replace the secondary-transfer-roller.
		The primary charging roller, developing roller, or photosensitive drum is deformed or has deteriorated.	Replace the toner cartridge of the color that matches the defect.
		The fuser roller is deformed or has deteriorated.	Replace the fuser.
		The high-voltage power-supply T PCA is defective (no transfer bias output).	Replace the high-voltage power-supply upper.
The toner is not fully fused to the paper.		The fuser roller or pressure roller is scarred or deformed.	Replace the fuser.
		The thermistor is defective.	Replace the fuser.
		The fuser heater is defective.	

Table 2-20 Image defects table (continued)





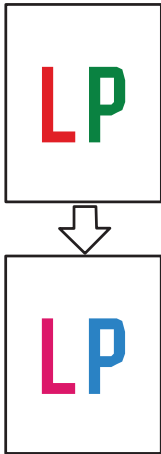

Problem	Sample	Cause	Solution
Some color is misregistered.		The product is incorrectly calibrated.	Calibrate the product.
		The ITB unit is defective.	If the ITB does not rotate smoothly or a cleaning malfunction occurs (ITB is dirty), replace the ITB.
		The drive gear of the ITB motor is worn or chipped.	Check each drive gear between the ITB drive roller and the ITB motor. If the gear is worn or chipped, replace the drive unit.
		The RD sensor is defective.	Open and close the front door several times to clean the RD sensor. If the problem persists, replace the RD sensor.
		The laser/scanner unit is defective.	Replace the laser/scanner assembly.
Toner smears appear on the paper.		The product has residual paper.	Remove the residual paper.
		The fuser inlet guide is dirty.	Clean the fuser inlet guide.
The printed page contains misformed characters.		The product is experiencing page skew.	See the "Text or graphics are skewed on the printed page" row in this table.
		The laser/scanner unit is defective.	Replace the laser/scanner assembly.
Text or graphics are skewed on the printed page.		The registration shutter spring is unhooked.	Check the spring and place it in the correct position.
		The registration shutter spring is deformed.	Replace the secondary transfer assembly.
The printed page contains wrinkles or creases.		The roller or paper feed guide is dirty.	Clean any dirty components.
		A feed roller is deformed or has deteriorated.	Replace any deformed or deteriorated rollers.
		The paper feed guide is damaged.	Replace the paper-feed-guide unit.

Table 2-20 Image defects table (continued)

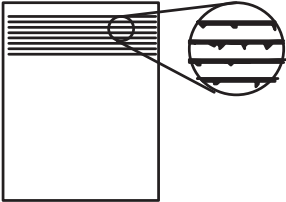
Problem	Sample	Cause	Solution
The front of the page is dirty.		<p>The photosensitive drum is dirty.</p> <p>The fuser roller or pressure roller is dirty.</p>	<p>Replace the toner cartridge.</p> <p>Execute a Pressure roller clean mode procedure. If the dirt does not come off, replace the fuser.</p> <p>NOTE: Cleaning the fuser with HP tough paper provides better results than with plain paper. You might need to execute the cleaning process several times to remove all contaminants on the fuser.</p>
Repetitive horizontal lines			<p>See repetitive image defect ruler. Clean the indicated roller. If the contaminant does not come off, replace appropriate roller or assembly.</p>
Pages have flecks of toner			<p>Execute a cleaning page to clean the contaminant off the fuser. The cleaning page might need to be run several times to clean the fuser. Do not replace the fuser.</p> <p>NOTE: Cleaning the fuser with HP tough paper provides better results than with plain paper. You might need to execute the cleaning process several times to remove all contaminants on the fuser.</p>
Pages have one or more skewed color planes (can appear on the right or left side of the page)			<p>Remove, and then reinstall the toner cartridge associated with the defect.</p>

Improve print quality

If the product is having print-quality problems, try the following solutions in the order presented to resolve the issue.

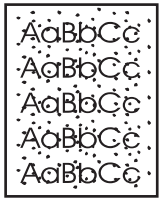
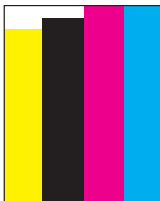
If the product is having scan, fax, or copy quality problems, try the following solutions and also see “Improve scan quality,” “Improve fax quality,” or “Improve copy quality” for further solutions.

- [Print from a different software program](#)
- [Check the paper-type setting for the print job](#)
- [Check toner-cartridge status](#)

- [Print and interpret the print quality page](#)
- [Clean the product](#)
- [Visually inspect the toner cartridge](#)
- [Check paper and the printing environment](#)
- [Calibrate the product to align the colors](#)
- [Check other print job settings](#)
- [Try a different print driver](#)

Print from a different software program

Try printing from a different software program. If the page prints correctly, the problem is with the software program from which you were printing.

Check the paper-type setting for the print job

Check the paper type setting when printing from a software program and the printed pages have smears, fuzzy or dark print, curled paper, scattered dots of toner, loose toner, or small areas of missing toner.

Check the paper type setting (Windows)

1. From the software program, select the **Print** option.
2. Select the product, and then click the **Properties** or **Preferences** button.
3. Click the **Paper/Quality** tab.
4. From the **Paper Type** drop-down list, click the **More...** option.
5. Expand the list of **Type is:** options.
6. Expand the category of paper types that best describes your paper.
7. Select the option for the type of paper you are using, and click the **OK** button.
8. Click the **OK** button to close the **Document Properties** dialog box. In the **Print** dialog box, click the **OK** button to print the job.

Check the paper type setting (Mac OS X)

1. Click the **File** menu, and then click the **Print** option.
2. In the **Printer** menu, select the product.
3. By default, the print driver displays the **Copies & Pages** menu. Open the menus drop-down list, and then click the **Finishing** menu.
4. Select a type from the **Media Type** drop-down list.
5. Click the **Print** button.

Check toner-cartridge status

Check the supplies status page for the following information:

- Estimated percentage of cartridge life remaining
- Approximate pages remaining
- Part numbers for HP toner cartridges
- Number of pages printed

Use the following procedure to print the supplies status page:

1. From the Home screen on the product control panel, touch the Supplies  button.
2. Touch the **Report** button to print the supplies status page.
3. Check the percent of life remaining for the toner cartridges and if applicable, the status of other replaceable maintenance parts.

Print quality problems can occur when using a toner cartridge that is at its estimated end of life. The supplies status page indicates when a supply level is very low. After an HP supply has reached the very low threshold, HP's premium protection warranty on that supply has ended.

The toner cartridge does not need to be replaced now unless the print quality is no longer acceptable. Consider having a replacement available to install when print quality is no longer acceptable.

If you determine that you need to replace a toner cartridge or other replaceable maintenance parts, the supplies status page lists the genuine HP part numbers.

4. Check to see if you are using a genuine HP cartridge.

A genuine HP toner cartridge has the words "HP" or "Hewlett-Packard" on it, or has the HP logo on it. For more information on identifying HP cartridges go to www.hp.com/go/learnaboutsupplies.

Hewlett Packard cannot recommend the use of non-HP supplies, either new or remanufactured. Because they are not HP products, HP cannot influence their design or control their quality. If you are using a refilled or remanufactured toner cartridge and are not satisfied with the print quality, replace the toner cartridge with a genuine HP toner cartridge.

Print and interpret the print quality page

1. From the Home screen, touch the Setup  button.
2. Touch the **Reports** button.
3. Touch the **Print Quality Page** button.

This page contains five bands of color, which are divided into four groups as indicated in the following illustration. By examining each group, you can isolate the problem to a particular toner cartridge.

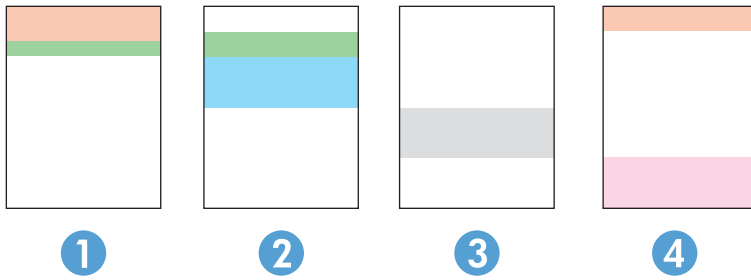

Section	Toner cartridge
1	Yellow
2	Cyan
3	Black
4	Magenta

- If dots or streaks appear in only one of the groups, replace the toner cartridge that correlates with that group.
- If dots appear in more than one group, print a cleaning page. If this does not solve the problem, determine if the dots are always the same color; for example, if magenta dots appear in all five color bands. If the dots are all the same color, replace that toner cartridge.
- If streaks appear in multiple color bands, contact HP. A component other than the toner cartridge is probably causing the problem.

Clean the product

Print a cleaning page

During the printing process paper, toner, and dust particles can accumulate inside the product and can cause print-quality issues such as toner specks or spatter, smears, streaks, lines, or repeating marks.

Use the following procedure to print a cleaning page.

1. From the Home screen on the product control panel, touch the Setup  button.
2. Touch the [Service](#) menu.
3. Touch the [Cleaning Page](#) button.
4. Load plain letter or A4 paper when you are prompted.
5. Touch the [OK](#) button to begin the cleaning process.

The product prints the first side and then prompts you to remove the page from the output bin and reload it in Tray 1, keeping the same orientation. Wait until the process is complete. Discard the page that prints.

Check the scanner glass for dirt and smudges

Over time, specks of debris might collect on the scanner glass and white plastic backing, which can affect performance. Use the following procedure to clean the scanner.

1. Press the power button to turn the product off, and then disconnect the power cable from the electrical outlet.
2. Open the scanner lid.
3. Clean the scanner glass and the white plastic backing underneath the scanner lid with a soft cloth or sponge that has been moistened with nonabrasive glass cleaner.

 **CAUTION:** Do not use abrasives, acetone, benzene, ammonia, ethyl alcohol, or carbon tetrachloride on any part of the product; these can damage the product. Do not place liquids directly on the glass or platen. They might seep and damage the product.

4. Dry the glass and white plastic parts with a chamois or a cellulose sponge to prevent spotting.
5. Connect the power cable to an outlet, and then press the power button to turn the product on.

Visually inspect the toner cartridge

1. Remove the toner cartridge from the product, and verify that the sealing tape has been removed.
2. Check the memory chip for damage.
3. Examine the surface of the imaging drum on the toner cartridge.

 **CAUTION:** Do not touch the roller (imaging drum) on the cartridge. Fingerprints on the imaging drum can cause print-quality problems.

4. If you see any scratches, fingerprints, or other damage on the imaging drum, replace the toner cartridge.
5. If the imaging drum does not appear to be damaged, rock the toner cartridge gently several times and reinstall it. Print a few pages to see if the problem has resolved.

Check paper and the printing environment

Step one: Use paper that meets HP specifications

Some print-quality problems arise from using paper that does not meet HP specifications.

- Always use a paper type and weight that this product supports.
- Use paper that is of good quality and free of cuts, nicks, tears, spots, loose particles, dust, wrinkles, voids, staples, and curled or bent edges.
- Use paper that has not been previously printed on.
- Use paper that does not contain metallic material, such as glitter.
- Use paper that is designed for use in laser printers. Do not use paper that is designed only for use in Inkjet printers.
- Use paper that is not too rough. Using smoother paper generally results in better print quality.

Step two: Check the environment

The environment can directly affect print quality and is a common cause for print-quality or paper-feeding issues. Try the following solutions:

- Move the product away from drafty locations, such as open windows or doors, or air-conditioning vents.
- Make sure the product is not exposed to temperatures or humidity outside of product specifications.
- Do not place the product in a confined space, such as a cabinet.
- Place the product on a sturdy, level surface.
- Remove anything that is blocking the vents on the product. The product requires good air flow on all sides, including the top.
- Protect the product from airborne debris, dust, steam, grease, or other elements that can leave residue inside the product.

Calibrate the product to align the colors

Calibration is a product function that optimizes print quality.

Follow these steps to resolve print quality problems such as misaligned color, colored shadows, blurry graphics, or other print-quality issues.

1. On the product control panel, touch the Setup  button.
2. Open the following menus:
 - [System Setup](#)
 - [Print Quality](#)
 - [Color Calibration](#)
 - [Calibrate Now](#)
3. A **Calibrating** message will display on the product control panel. The calibration process takes a few minutes to complete. Do not turn the product off until the calibration process has finished.
4. Wait while the product calibrates, and then try printing again.

Check other print job settings

When printing from a software program, follow these steps to try to resolve the issue by adjusting other print-driver settings.

Check the EconoMode settings

HP does not recommend the full-time use of EconoMode. If EconoMode is used full-time, the toner supply might outlast the mechanical parts in the toner cartridge. If print quality begins to degrade and is no longer acceptable, consider replacing the toner cartridge.



NOTE: This feature is available with the PCL 6 print driver for Windows. If you are not using that driver, you can enable the feature by using the HP Embedded Web Server.

Follow these steps if the entire page is too dark or too light.

1. From the software program, select the **Print** option.
2. Select the product, and then click the **Properties** or **Preferences** button.
3. Click the **Paper/Quality** tab, and locate the **Print Quality** area.

4. If the entire page is too dark, use these settings:

- Select the **600 dpi** option.
- Select the **EconoMode** check box to enable it.

If the entire page is too light, use these settings:

- Select the **FastRes 1200** option.
- Clear the **EconoMode** check box to disable it.

5. Click the **OK** button to close the **Document Properties** dialog box. In the **Print** dialog, click the **OK** button to print the job.

Adjust color settings (Windows)

Follow these steps if colors on the printed page do not match colors on the computer screen, or if the colors on the printed page are not satisfactory.

Change the color theme

1. From the software program, select the **Print** option.
2. Select the product, and then click the **Properties** or **Preferences** button.
3. Click the **Color** tab.
4. Select the **HP EasyColor** check box to clear it.
5. Select a color theme from the **Color Themes** drop-down list.
 - **Default (sRGB)**: This theme sets the product to print RGB data in raw device mode. When using this theme, manage color in the software program or in the operating system for correct rendering.
 - **Vivid (sRGB)**: The product increases the color saturation in the midtones. Use this theme when printing business graphics.
 - **Photo (sRGB)**: The product interprets RGB color as if it were printed as a photograph using a digital mini lab. The product renders deeper, more saturated colors differently than with the Default (sRGB) theme. Use this theme when printing photos.
 - **Photo (Adobe RGB 1998)**: Use this theme with printing digital photos that use the AdobeRGB color space rather than sRGB. Turn off color management in the software program when using this theme.
 - **None**: No color theme is used.
 - **Custom Profile**: Select this option to use a custom input profile to accurately control color output (for example, to emulate a specific HP Color LaserJet product). Download custom profiles from www.hp.com.
6. Click the **OK** button to close the **Document Properties** dialog box. In the **Print** dialog box, click the **OK** button to print the job.

Change the color options

1. From the software program, select the **Print** option.
2. Select the product, and then click the **Properties** or **Preferences** button.

3. Click the **Color** tab.
 4. Select the **HP EasyColor** check box to clear it.
 5. Click the **Automatic** or **Manual** setting.
 - **Automatic** setting: Select this setting for most color print jobs
 - **Manual** setting: Select this setting to adjust the color settings independently from other settings. Click the **Settings** button to open the manual color-adjustment window.
-
-  **NOTE:** Changing color settings manually can impact output. HP recommends that only color graphics experts change these settings.
-
6. Click the **Print in Grayscale** option to print a color document in black and shades of gray. Use this option to print color documents for photocopying or faxing. Also use this option to print draft copies or to save color toner.
 7. Click the **OK** button to close the **Document Properties** dialog box. In the **Print** dialog box, click the **OK** button to print the job.

Try a different print driver

You might need to use a different print driver when printing from a software program and the printed pages have unexpected lines in graphics, missing text, missing graphics, incorrect formatting, or substituted fonts.

Download any of the following drivers from the HP Web site. In the US, go to www.hp.com/support/colorljMFPM476. Outside the US, go to www.hp.com/support. Select your country/region. Click **Download Drivers & Software**. Enter the product name, and then select **Search**.

HP PCL 6 driver	<ul style="list-style-type: none"> • Provided as the default driver on the product CD. This driver is automatically installed unless you select a different one. • Recommended for all Windows environments • Provides the overall best speed, print quality, and product-feature support for most users • Developed to align with the Windows Graphic Device Interface (GDI) for the best speed in Windows environments • Might not be fully compatible with third-party and custom software programs that are based on PCL 5
HP UPD PS driver	<ul style="list-style-type: none"> • Recommended for printing with Adobe® software programs or with other highly graphics-intensive software programs • Provides support for printing from postscript emulation needs, or for postscript flash font support

HP UPD PCL 5

- Recommended for general office printing in Windows environments
- Compatible with previous PCL versions and older HP LaserJet products
- The best choice for printing from third-party or custom software programs
- The best choice when operating with mixed environments, which require the product to be set to PCL 5 (UNIX, Linux, mainframe)
- Designed for use in corporate Windows environments to provide a single driver for use with multiple product models
- Preferred when printing to multiple product models from a mobile Windows computer

HP UPD PCL 6

- Recommended for printing in all Windows environments
- Provides the overall best speed, print quality, and printer feature support for most users
- Developed to align with Windows Graphic Device Interface (GDI) for best speed in Windows environments
- Might not be fully compatible with third-party and custom software programs that are based on PCL 5

General print-quality issues

The following examples depict letter-size paper that has passed through the product short-edge-first. These examples illustrate problems that would affect all of the pages that you print. The topics that follow list the typical cause and solution for each of these examples.

Table 2-21 General print-quality issues

Problem	Cause	Solution
Print is light or faded.	The paper might not meet HP specifications.	Use paper that meets HP specifications.
	The toner cartridge might be defective or low. If you use a non-HP toner cartridge, no messages appear on the product control panel.	Replace the toner cartridge. If the toner cartridge is not low or empty, inspect the toner roller to see if the roller is damaged. If it is, replace the toner cartridge.
	If the whole page is light, the print density adjustment is too light or EconoMode might be turned on.	Adjust the print density, and disable EconoMode in the print driver.
Toner specks appear.	The paper might not meet HP specifications.	Use paper that meets HP specifications.
	The paper path might need cleaning.	Clean the paper path.

Table 2-21 General print-quality issues (continued)



Problem	Cause	Solution
Dropouts appear.	A single sheet of paper might be defective.	Try reprinting the job.
	The moisture content of the paper is uneven or the paper has moist spots on its surface.	Try different paper, such as high-quality paper that is intended for laser printers.
	The paper lot is flawed. The manufacturing processes can cause some areas to reject toner.	
	The toner cartridge might be defective or low.	Replace the toner cartridge.
Vertical streaks or bands appear on the page.	The toner cartridge might be defective.	Replace the toner cartridge.
		
The amount of background toner shading becomes unacceptable.	The paper might not meet HP specifications.	Use a different paper with a lighter basis weight.
	The print-density setting is too high.	Decrease the print-density setting. This decreases the amount of background shading.
	Very dry (low humidity) conditions can increase the amount of background shading.	Check the product environment.
	The toner cartridge might be defective or low.	Replace the toner cartridge.
Toner smears appear on the paper.	The paper might not meet HP specifications.	Use paper that meets HP specifications.
	If toner smears appear on the leading edge of the paper, the paper guides are dirty, or debris has accumulated in the print path.	Clean the paper guides and the paper path.
	The toner cartridge might be defective.	Replace the toner cartridge.
	The fuser temperature might be too low.	In the print driver, make sure the appropriate paper type is selected.

Table 2-21 General print-quality issues (continued)

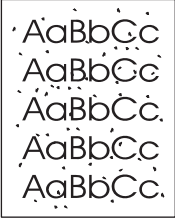

Problem	Cause	Solution
<p>The toner smears easily when touched.</p> 	The product is not set to print on the type of paper on which you want to print.	In the print driver, select the Paper/Quality tab and set Paper Type to match the type of paper on which you are printing. Print speed might be slower if you are using heavy paper.
	The paper might not meet HP specifications.	Use paper that meets HP specifications.
	The paper path might need cleaning.	Clean the paper path.
	The power source might be defective.	Plug the product directly into an AC outlet instead of into a power strip.
	The fuser temperature might be too low.	In the print driver, make sure the appropriate paper type is selected.
<p>Marks repeatedly appear at even intervals on the page.</p> 	The product is not set to print on the type of paper on which you want to print.	In the print driver, select the Paper/Quality tab and set Paper Type to match the type of paper on which you are printing. Print speed might be slower if you are using heavy paper.
	Internal parts might have toner on them.	The problem typically corrects itself after a few more pages.
	The paper path might need cleaning.	Clean the paper path.
	A component might be damaged.	Use the repetitive defect ruler table to determine the problem.
<p>The printed page contains misformed characters.</p> 	The paper might not meet HP specifications.	Use a different paper, such as high-quality paper that is intended for laser printers.
	If characters are incorrectly formed so that they produce a wavy effect, the laser/scanner might need service.	Replace the laser/scanner.

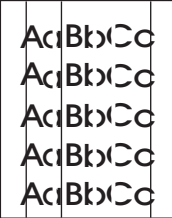
Table 2-21 General print-quality issues (continued)

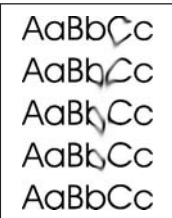

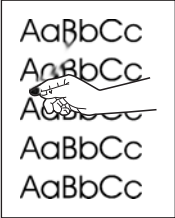

Problem	Cause	Solution
<p>The printed page is curled or wavy.</p> 	The product is not set to print on the type of paper on which you want to print.	<p>In the print driver, select the Paper/Quality tab and set Paper Type to match the type of paper on which you are printing. Print speed might be slower if you are using heavy paper.</p> <p>If the problem persists, select a paper type that uses a lower fuser temperature, such as transparencies or light paper.</p>
	The paper might have been in the input tray too long.	Turn over the stack of paper in the tray. Also, try rotating the paper 180° in the input tray.
	The paper might not meet HP specifications.	Use a different paper, such as high-quality paper that is intended for laser printers.
	Both high temperature and humidity can cause paper curl.	Check the product environment.
	The fuser temperature might be curling the paper.	<p>Select a paper type that uses a lower fuser temperature, such as transparencies or light paper.</p> <p>At the product control panel, turn on the Less paper curl setting in the Service menu.</p>
<p>Text or graphics are skewed on the printed page.</p> 	The paper might be loaded incorrectly or the input tray might be too full.	Verify that the paper is loaded correctly and that the paper guides are not too tight or too loose against the stack.
	The paper might not meet HP specifications.	Use a different paper, such as high-quality paper that is intended for laser printers.
<p>The printed page contains wrinkles or creases.</p> 	The paper might be loaded incorrectly or the input tray might be too full.	<p>Turn over the stack of paper in the input tray, or try rotating the paper 180° in the input tray.</p> <p>Verify that the paper is loaded correctly and that the paper guides are not too tight or too loose against the stack.</p>
	There might be a jam in the paper path.	Clear any jams in the product.
	The paper might not meet HP specifications.	Use a different paper, such as high-quality paper that is intended for laser printers.
	Air pockets inside envelopes can cause them to wrinkle.	Remove the envelope, flatten it, and try printing again.

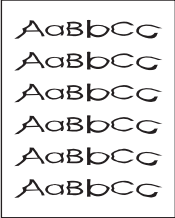
Table 2-21 General print-quality issues (continued)

Problem	Cause	Solution
<p>Toner appears around the printed characters.</p> 	<p>The paper might be loaded incorrectly.</p> <p>If large amounts of toner have scattered around the characters, the paper might have high resistivity.</p>	<p>Turn over the stack of paper in the tray.</p> <p>Use a different paper, such as high-quality paper that is intended for laser printers.</p>
<p>An image that appears at the top of the page (in solid black) repeats farther down the page (in a gray field).</p> 	<p>Software settings might affect image printing.</p> <p>The order of images printed might affect printing.</p> <p>A power surge might have affected the product.</p>	<p>In your software program, change the tone (darkness) of the field in which the repeated image appears.</p> <p>In your software program, rotate the whole page 180° to print the lighter image first.</p> <p>Change the order in which the images are printed. For example, have the lighter image at the top of the page, and the darker image farther down the page.</p> <p>If the defect occurs later in a print job, turn the product off for 10 minutes, and then turn on the product to restart the print job.</p>

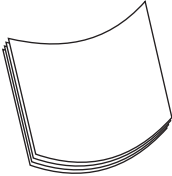
Solve paper-handling problems

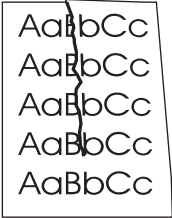
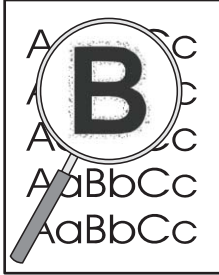
Product feeds incorrect page size

Product feeds incorrect page size	
Cause	Solution
The correct size paper is not loaded in the tray.	Load the correct size paper in the tray.
The correct size paper is not selected in the software program or printer driver.	Confirm that the settings in the software program and printer driver are correct, because the software program settings override the printer driver and control panel settings, and the printer driver settings override the control panel settings.
The correct size paper for the tray is not selected in the product control panel.	From the control panel, select the correct size paper for the tray.
The paper size is not configured correctly for the tray.	Print a configuration page or use the control panel to determine the paper size for which the tray is configured.
The guides in the tray are not against the paper.	Verify that the paper guides are touching the paper.

Product pulls from incorrect tray

Product pulls from incorrect tray	
Cause	Solution
You are using a driver for a different product.	Use a driver for this product.
The specified tray is empty.	Load paper in the specified tray.
The paper size is not configured correctly for the input tray.	Print a configuration page or use the control panel to determine the paper size for which the tray is configured.
The guides in the tray are not against the paper.	Verify that the guides are touching the paper.

Paper does not feed automatically

Paper does not feed automatically	
Cause	Solution
Manual feed is selected in the software program.	Load Tray 1 with paper, or, if the paper is loaded, press the OK button.
The correct size paper is not loaded.	Load the correct size paper.
The input tray is empty.	Load paper into the input tray.
Paper from a previous jam has not been completely removed.	Open the product and remove any paper in the paper path.
The paper size is not configured correctly for the input tray.	Print a configuration page or use the control panel to determine the paper size for which the tray is configured.
The guides in the tray are not against the paper.	Verify that the rear and width paper guides are touching the paper.

Paper does not feed automatically

Cause	Solution
The Manually Feed Prompt item is set to Always . The product always prompts for manual feed, even if the tray is loaded.	Open the tray, reload the media, and then close the tray. Or, change the Manually Feed Prompt setting to Unless loaded , so that the product prompts for manual feed only when the tray is empty.
The Use Requested Tray setting on the product is set to Exclusively , and the requested tray is empty. The product will not use another tray.	Load the requested tray. Or, change the setting from Exclusively to First on the Manage Trays menu. The product can use other trays if no media is loaded in the specified tray.

Paper does not feed from Tray 2 or 3

Paper does not feed from Tray 2 or 3

Cause	Solution
The correct size paper is not loaded.	Load the correct size paper.
The input tray is empty.	Load paper in the input tray.
The correct paper type for the input tray is not selected in the product control panel.	From the product control panel, select the correct paper type for the input tray. Trays configured for a paper type with a specific weight range will not match a print job that specifies an exact weight, even if the specified weight is within the weight range.
Paper from a previous jam has not been completely removed.	Open the product and remove any paper in the paper path. Closely inspect the fuser area for jams.
None of the optional trays appear as input tray options.	The optional trays only display as available if they are installed. Verify that any optional trays are correctly installed. Verify that the printer driver has been configured to recognize the optional trays.
An optional tray is incorrectly installed.	Print a configuration page to confirm that the optional tray is installed. If not, verify that the tray is correctly attached to the product.
The paper size is not configured correctly for the input tray.	Print a configuration page or use the control panel to determine the paper size for which the tray is configured.
The guides in the tray are not against the paper.	Verify that the guides are touching the paper.

Output is curled or wrinkled

Output is curled or wrinkled

Cause	Solution
Paper does not meet the specifications for this product.	Use only paper that meets the HP paper specifications for this product.
Paper is damaged or in poor condition.	Remove paper from the input tray and load paper that is in good condition.

Output is curled or wrinkled

Cause	Solution
Product is operating in an excessively humid environment.	Verify that the printing environment is within humidity specifications.
You are printing large, solid-filled areas.	Large, solid-filled areas can cause excessive curl. Try using a different pattern.
Paper used was not stored correctly and might have absorbed moisture.	Remove paper and replace it with paper from a fresh, unopened package.
Paper has poorly cut edges.	Remove paper, flex it, rotate it 180 degrees or turn it over, and then reload it into the input tray. Do not fan paper. If the problem persists, replace the paper.
The specific paper type was not configured for the tray or selected in the software.	Configure the software for the paper (see the software documentation). Configure the tray for the paper.
The paper has previously been used for a print job.	Do not re-use paper.

Product will not duplex or duplexes incorrectly

Product will not duplex (print 2-sided jobs) or duplexes incorrectly

Cause	Solution
You are trying to duplex on unsupported paper.	Verify that the paper is supported for duplex printing.
The printer driver is not set up for duplex printing.	Set up the printer driver to enable duplex printing.
The first page is printing on the back of preprinted forms or letterhead.	Load preprinted forms and letterhead in Tray 1 with the letterhead or printed side down, with the top of the page leading into the product. For Tray 2 and 3, load the paper printed side up with the top of the page toward the right of the product.
The product model does not support automatic 2-sided printing.	The product model does not support automatic 2-sided printing.
The product configuration is not set for duplexing.	In Windows, run the automatic configuration feature: <ol style="list-style-type: none">1. Click the Start button, point to Settings, and then click Printers (for Windows 2000) or Printers and Faxes (for Windows XP).2. Right-click the HP product icon, and then click Properties or Printing Preferences.3. Click the Device Settings tab.4. Under Installable Options, click Update Now in the Automatic Configuration list.

Clean the product

Clean the pickup and separation rollers

1. Turn off the product, unplug the power cable from the product, and then remove the rollers.
2. Dab a lint-free cloth in isopropyl alcohol, and then scrub the roller.

 **WARNING!** Alcohol is flammable. Keep the alcohol and cloth away from an open flame. Before you close the product and connect the power cable, allow the alcohol to dry completely.

 **NOTE:** In certain areas of California (USA), air pollution control regulations restrict the use of liquid isopropyl alcohol (IPA) as a cleaning agent. In those areas of California, please disregard the previous recommendations and use a dry, lint free cloth, moistened with water, to clean the pickup roller.

3. Use a dry, lint free cloth, to wipe the rollers and remove loose dirt.

Clean the paper path

During the printing process, paper, toner, and dust particles can accumulate inside the product. Over time, this buildup can cause print-quality problems such as toner specks or smearing. This product has a cleaning mode that can correct and prevent these types of problems.

1. From the Home screen on the product control panel, touch the Setup  button.
2. Touch the [Service](#) menu.
3. Touch the [Cleaning Page](#) button.
4. Load plain letter or A4 paper when you are prompted.
5. Touch the [OK](#) button to begin the cleaning process.

Wait until the process is complete. Discard the page that prints.

Clean the scanner glass strip and platen

Over time, specks of debris might collect on the scanner glass and white plastic backing, which can affect performance. Use the following procedure to clean the scanner glass and white plastic backing.

1. Use the power switch to turn off the product, and then unplug the power cable from the electrical socket.
2. Open the scanner lid.

3. Clean the scanner glass and the white plastic backing with a soft cloth or sponge that has been moistened with nonabrasive glass cleaner.

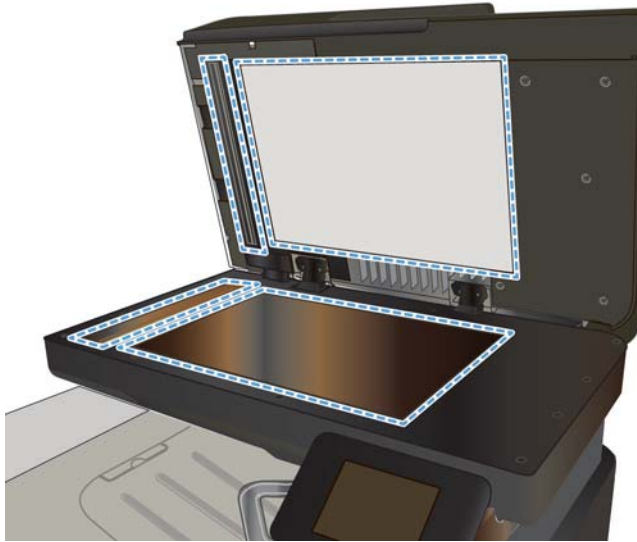

⚠ CAUTION: Do not use abrasives, acetone, benzene, ammonia, ethyl alcohol, or carbon tetrachloride on any part of the product; these can damage the product. Do not place liquids directly on the glass or platen. They might seep and damage the product.

4. Dry the glass and white plastic backing with a chamois or a cellulose sponge to prevent spotting.
5. Connect the product, and then use the power switch to turn on the product.

Clean the document feeder pickup rollers and separation pad

If the product document feeder experiences paper-handling problems, such as jams or multiple-page feeds, clean the document feeder rollers and separation pad.

1. Open the document feeder cover.



2. Use a moist, lint-free cloth to wipe both pickup rollers and the separation pad to remove dirt.

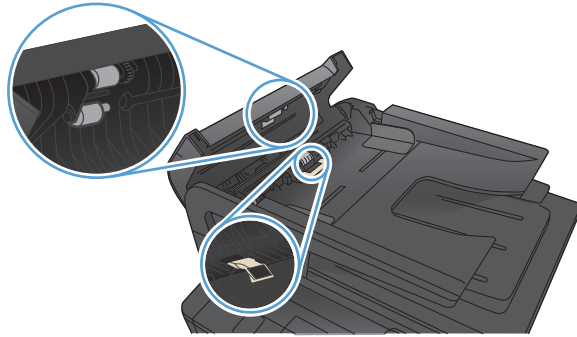

3. Close the document feeder cover.

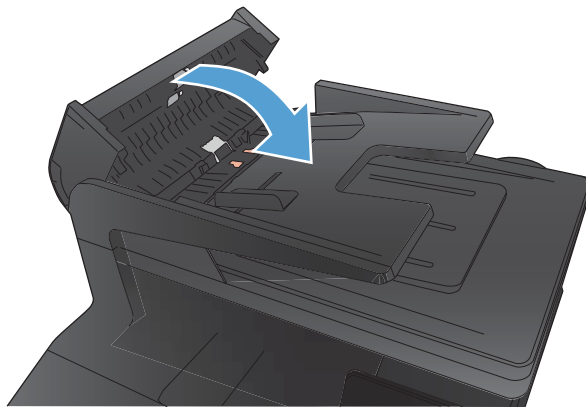

Clean the touchscreen

Clean the touchscreen whenever it is necessary to remove fingerprints or dust. Wipe the touchscreen gently with a clean, water-dampened, lint-free cloth.

CAUTION: Use water only. Solvents or cleaners can damage the touch screen. Do not pour or spray water directly onto the touchscreen.

Solve performance problems

Factors affecting print performance

Table 2-22 Factors affecting print performance

Problem	Cause	Solution
Pages print but, are totally blank.	The sealing tape might still be in the toner cartridges.	Verify that the sealing tape has been completely removed from the toner cartridges.
	The document might contain blank pages.	Check the document that you are printing to see if content appears on all of the pages.
	The product might be malfunctioning.	To check the product, print a Configuration page.
Pages print very slowly. NOTE: The product print speed is effected by various factors (for example, media size or page complexity).	Heavier media types can slow the print job.	Print on a different type of media.
	Complex pages can print slowly.	Proper fusing might require a slower print speed to ensure the best print quality.
	Paper type not set correctly.	Select the type to match the paper.
Pages did not print.	The product might not be pulling media correctly.	Ensure paper is loaded in the tray correctly. If the problem persists, you might need to replace the pickup rollers and the separation pad.
	The media is jamming in the product.	Clear the jam.
	The USB cable might be defective or incorrectly connected.	<ul style="list-style-type: none">• Disconnect the USB cable at both ends and reconnect it.• Try printing a job that has printed in the past.• Try using a different USB cable.
	Other devices are running on your computer.	The product might not share a USB port. If you have an external hard drive or network switchbox that is connected to the same port as the product, the other device might be interfering. To connect and use the product, you must disconnect the other device or you must use two USB ports on the computer.

Print speeds

Print speed is the number of pages that print in one minute. Print speed depends on different engine-process speeds or operational pauses between printed pages during normal product operation. Factors that determine the print speed of the product include the following:

- Page formatting time

The product must pause for each page to be formatted before it prints. Complex pages take more time to format, resulting in reduced print speed. However, most jobs print at full engine speed (35 ppm on Letter-size media or 33 ppm on A4-size media).

- **Media size**

Legal-size media reduces print speed because it is longer than the standard Letter- or A4-size media. A reduce print speed is used when printing on narrow media to prevent the edges of the fuser from overheating.

- **Media mode**

Some media types require a reduced print speed to achieve maximum print quality on that media. For example, glossy, heavy, and specialty media (for example, envelopes or photos) require a reduced print speed. To maximize the print speed for special media types, ensure that you select the correct media type in the print driver.

- **Product temperature**

To prevent product damage, print speed is reduced if the product reaches a specific internal temperature (thermal slow down). The starting temperature of the product, ambient environment temperature, and the print job size effect the number of pages that can be printed before the product reduces the print speed. Thermal slow down reduces print speed by printing four pages and then pausing for an amount of time before printing continues.

- **Other print speed reduction factors**

Other factors (especially during large print jobs) that can cause reduced print speeds include:

- Density control sequence; occurs every 150 pages and takes about 120 seconds.

The product does not print or it prints slowly

The product does not print

If the product does not print at all, try the following solutions.

1. Make sure the product is turned on and that the control panel indicates it is ready.
 - If the control panel does not indicate the product is ready, turn the product off and then on again.
 - If the control panel indicates the product is ready, try sending the job again.
2. If the control panel indicates the product has an error, resolve the error and then try sending the job again.
3. Make sure the cables are all connected correctly. If the product is connected to a network, check the following items:
 - Check the light next to the network connection on the product. If the network is active, the light is green.
 - Make sure that you are using a network cable and not a phone cord to connect to the network.
 - Make sure the network router, hub, or switch is turned on and that it is working correctly.
4. Install the HP software from the CD that came with the product. Using generic printer drivers can cause delays clearing jobs from the print queue.

5. From the list of printers on your computer, right-click the name of this product, click **Properties**, and open the **Ports** tab.
 - If you are using a network cable to connect to the network, make sure the printer name listed on the **Ports** tab matches the product name on the product configuration page.
 - If you are using a USB cable and are connecting to a wireless network, make sure the box is checked next to **Virtual printer port for USB**.
6. If you are using a personal firewall system on the computer, it might be blocking communication with the product. Try temporarily disabling the firewall to see if it is the source of the problem.
7. If your computer or the product is connected to a wireless network, low signal quality or interference might be delaying print jobs.

The product prints slowly

If the product prints, but it seems slow, try the following solutions.

1. Make sure the computer meets the minimum specifications for this product. For a list of specifications, go to this Web site: www.hp.com/support/colorljMFPM476.
2. When you configure the product to print on some paper types, such as heavy paper, the product prints more slowly so it can correctly fuse the toner to the paper. If the paper type setting is not correct for the type of paper you are using, change the setting to the correct paper type.
3. If your computer or the product is connected to a wireless network, low signal quality or interference might be delaying print jobs.

Solve connectivity problems

Solve USB connection problems

If you have connected the product directly to a computer, check the cable.

- Verify that the cable is connected to the computer and to the product.
- Verify that the cable is not longer than 5 m (16.4 ft). Try using a shorter cable.
- Verify that the cable is working correctly by connecting it to another product. Replace the cable if necessary.

Solve wired network problems

Check the following items to verify that the product is communicating with the network. Before beginning, print a configuration page from the product control panel and locate the product IP address that is listed on this page.

- [Poor physical connection](#)
- [The computer is using the incorrect IP address for the product](#)
- [The computer is unable to communicate with the product](#)
- [The product is using incorrect link and duplex settings for the network](#)
- [New software programs might be causing compatibility problems](#)
- [The computer or workstation might be set up incorrectly](#)
- [The product is disabled, or other network settings are incorrect](#)



NOTE: HP does not support peer-to-peer networking, as the feature is a function of Microsoft operating systems and not of the HP print drivers. For more information, go to Microsoft at www.microsoft.com.

Poor physical connection

1. Verify that the product is attached to the correct network port using a cable of the correct length.
2. Verify that cable connections are secure.
3. Look at the network port connection on the back of the product, and verify that the amber activity light and the green link-status light are lit.
4. If the problem continues, try a different cable or port on the hub.

The computer is using the incorrect IP address for the product

1. Open the printer properties and click the **Ports** tab. Verify that the current IP address for the product is selected. The product IP address is listed on the product configuration page.
2. If you installed the product using the HP standard TCP/IP port, select the box labeled **Always print to this printer, even if its IP address changes**.

3. If you installed the product using a Microsoft standard TCP/IP port, use the hostname instead of the IP address.
4. If the IP address is correct, delete the product and then add it again.

The computer is unable to communicate with the product

1. Test network communication by pinging the network.
 - a. Open a command-line prompt on your computer. For Windows, click **Start**, click **Run**, type `cmd`, and then press Enter.
 - b. Type `ping` followed by the IP address for your product.

For Mac OS X, open the Network Utility, and then supply the IP address in the correct field in the **Ping** pane.
 - c. If the window displays round-trip times, the network is working.
2. If the ping command failed, verify that the network hubs are on, and then verify that the network settings, the product, and the computer are all configured for the same network.

The product is using incorrect link and duplex settings for the network

Hewlett-Packard recommends leaving this setting in automatic mode (the default setting). If you change these settings, you must also change them for your network.

New software programs might be causing compatibility problems

Verify that any new software programs are correctly installed and that they use the correct print driver.

The computer or workstation might be set up incorrectly

1. Check the network drivers, print drivers, and the network redirection.
2. Verify that the operating system is configured correctly.

The product is disabled, or other network settings are incorrect

1. Review the configuration page to check the status of the network protocol. Enable it if necessary.
2. Reconfigure the network settings if necessary.

Solve wireless network problems

- [Wireless connectivity checklist](#)
- [The product does not print after the wireless configuration completes](#)
- [The product does not print, and the computer has a third-party firewall installed](#)
- [The wireless connection does not work after moving the wireless router or product](#)
- [Cannot connect more computers to the wireless product](#)
- [The wireless product loses communication when connected to a VPN](#)
- [The network does not appear in the wireless networks list](#)

- [The wireless network is not functioning](#)
- [Perform a wireless network diagnostic test](#)
- [Reduce interference on a wireless network](#)

Wireless connectivity checklist

- Verify that the network cable is not connected.
- Verify that the product and the wireless router are turned on and have power. Also make sure that the wireless radio in the product is turned on.
- Verify that the service set identifier (SSID) is correct. Print a configuration page to determine the SSID. If you are not sure the SSID is correct, run the wireless setup again.
- With secured networks, verify that the security information is correct. If the security information is incorrect, run the wireless setup again.
- If the wireless network is working correctly, try accessing other computers on the wireless network. If the network has Internet access, try connecting to the Internet over a wireless connection.
- Verify that the encryption method (AES or TKIP) is the same for the product as it is for the wireless access point (on networks using WPA/WPA2 security).
- Verify that the product is within the range of the wireless network. For most networks, the product must be within 30 m (100 ft) of the wireless access point (wireless router).
- Verify that obstacles do not block the wireless signal. Remove any large metal objects between the access point and the product. Make sure poles, walls, or support columns containing metal or concrete do not separate the product and wireless access point.
- Verify that the product is located away from electronic devices that might interfere with the wireless signal. Many devices can interfere with the wireless signal including motors, cordless phones, security system cameras, other wireless networks, and some Bluetooth devices.
- Verify that the print driver is installed on the computer.
- Verify that you have selected the correct printer port.
- Verify that the computer and product connect to the same wireless network.
- For Mac OS X, verify that the wireless router supports Bonjour.

The product does not print after the wireless configuration completes

1. Make sure that the product is turned on and in the ready state.
2. Turn off any third-party firewalls on your computer.
3. Make sure that the wireless network is working correctly.
4. Make sure that your computer is working correctly. If necessary, restart the computer.
5. Verify that you can open the product HP Embedded Web Server from a computer on the network.

The product does not print, and the computer has a third-party firewall installed

1. Update the firewall with the most recent update available from the manufacturer.
2. If programs request firewall access when you install the product or try to print, make sure you allow the programs to run.
3. Temporarily turn off the firewall, and then install the wireless product on the computer. Enable the firewall when you have completed the wireless installation.

The wireless connection does not work after moving the wireless router or product

1. Make sure that the router or product connects to the same network that your computer connects to.
2. Print a configuration page.
3. Compare the service set identifier (SSID) on the configuration page to the SSID in the product configuration for the computer.
4. If the numbers are not the same, the devices are not connecting to the same network. Reconfigure the wireless setup for the product.

Cannot connect more computers to the wireless product

1. Make sure that the other computers are within the wireless range and that no obstacles block the signal. For most networks, the wireless range is within 30 m (100 ft) of the wireless access point.
2. Make sure that the product is turned on and in the ready state.
3. Turn off any third-party firewalls on your computer.
4. Make sure that the wireless network is working correctly.
5. Make sure that your computer is working correctly. If necessary, restart the computer.

The wireless product loses communication when connected to a VPN

- Typically, you cannot connect to a VPN and other networks at the same time.

The network does not appear in the wireless networks list

- Make sure the wireless router is turned on and has power.
- The network might be hidden. However, you can still connect to a hidden network.

The wireless network is not functioning

1. Make sure that the network cable is not connected.
2. To verify if the network has lost communication, try connecting other devices to the network.
3. Test network communication by pinging the network.

- a. Open a command-line prompt on your computer. For Windows, click **Start**, click **Run**, type `cmd`, and then press Enter.
 - b. Type `ping` followed by the router IP address.

For Mac OS X, open the Network Utility, and then supply the IP address in the correct field in the **Ping** pane.
 - c. If the window displays round-trip times, the network is working.
4. Make sure that the router or product connects to the same network that the computer connects to.
 - a. Print a configuration page.
 - b. Compare the service set identifier (SSID) on the configuration report to the SSID in the product configuration for the computer.
 - c. If the numbers are not the same, the devices are not connecting to the same network. Reconfigure the wireless setup for the product.

Perform a wireless network diagnostic test

From the product control panel, you can run a diagnostic test that provides information about the wireless network settings.

1. From the Home screen on the product control panel, touch the Setup  button.
2. Open the [Self Diagnostics](#) menu.
3. Touch the [Run Wireless Test](#) button to start the test. The product prints a test page that shows test results.

Reduce interference on a wireless network

The following tips can reduce interference in a wireless network:

- Keep the wireless devices away from large metal objects, such as filing cabinets, and other electromagnetic devices, such as microwaves and cordless telephones. These objects can disrupt radio signals.
- Keep the wireless devices away from large masonry structures and other building structures. These objects can absorb radio waves and lower signal strength.
- Position the wireless router in a central location in line of sight with the wireless products on the network.

Solve fax problems

This section will discuss the following:

- The product does not pick up paper
- The product picks up multiple sheets of paper
- The document feeder jams, skews, or picks up multiple sheets of paper
- Prevent paper jams from the paper trays

Checklist for solving fax problems

- Several possible fixes are available. After each recommended action, retry faxing to see if the problem is resolved.
 - For best results during fax problem solving, make sure the line from the product is connected directly to the wall phone port. Disconnect all other devices that are connected to the product.
1. Verify that the telephone cord is connected to the correct port on the back of the product.
 2. Check the phone line by using the fax test:
 - a. From the Home screen on the product control panel, touch the Setup  button, and then touch the [Service](#) menu.
 - b. Select the [Self Diagnostics](#) menu.
 - c. Select the [Run Fax Test](#) option. The product prints a fax test report.

The report contains the following possible results:

- **Pass:** The report contains all of the current fax settings for review.
 - **Fail:** The report indicates the nature of the error and contains suggestions for how to resolve the issue.
3. Verify that the product firmware is current:
 - a. Print a configuration page from the control panel [Reports](#) menu to obtain the current firmware date code.
 - b. Go to www.hp.com.
 1. Click the **Support & Drivers** link.
 2. Click the **Download drivers and software (and firmware)** link option.
 3. In the **For product** box, enter the product model number, and then click the **Go** button.
 4. Click the link for your operating system.
 5. Scroll to the Firmware section of the table.

- If the listed version matches the version on the configuration page, you have the most current version.
- If the versions are different, download the firmware upgrade file and upgrade the firmware on the product following the on-screen instructions.



NOTE: The product must be connected to a computer with internet access to upgrade firmware.

- Resend the fax.

4. Verify that the fax was set up when the product software was installed.

From the computer, in the HP program folder, run the Fax Setup Utility.

5. Verify that the telephone service supports analog fax.

- If using ISDN or digital PBX, contact your service provider for information about configuring to an analog fax line.
- If using a VoIP service, change the **Fax Speed** setting to **Slow(V.29)** from the control panel. Ask if your service provider supports fax and for the recommended fax modem speed. Some companies might require an adapter.
- If you are using a DSL service, make sure that a filter is included on the phone-line connection to the product. Contact the DSL service provider, or purchase a DSL filter if you do not have one. If a DSL filter is installed, try another filter because filters can be defective.

6. If the error persists, find more detailed problem-solving solutions in the sections that follow this one.

Perform a fax diagnostic test

From the product control panel, you can run a diagnostic test that provides information about the product fax settings.

1. From the Home screen on the product control panel, touch the Setup  button.
2. Open the following menus:
 - **Service**
 - **Fax Service**
3. Touch the **Run Fax Test** button to start the test. The product prints a test page that shows test results.

Solve general fax problems

This section will discuss the following:

- Faxes are sending slowly
- Fax quality is poor
- Fax cuts off or prints on two pages

Faxes are sending slowly

The product is experiencing poor phone line quality.

- Retry sending the fax when the line conditions have improved.
- Check with the phone service provider that the line supports fax.
- Turn off the [Error Correction](#) setting.
 - a. Open the [Setup Menu](#) menu.
 - b. Open the [Service](#) menu.
 - c. Open the [Fax Service](#) menu.
 - d. Open the [Error Correction](#) menu.
 - e. Select the [Off](#) setting.

 **NOTE:** This can reduce image quality.

- Use white paper for the original. Do not use colors such as gray, yellow, or pink.
- Increase the [Fax Speed](#) setting.
 - a. Open the [Setup Menu](#) menu.
 - b. Open the [Fax Setup](#) menu.
 - c. Open the [Advanced Setup](#) menu.
 - d. Open the [Fax Speed](#) menu.
 - e. Select the correct setting.
- Divide large fax jobs into smaller sections, and then fax them individually.
- Change the fax settings on the control panel to a lower resolution.
 - a. Open the [Setup Menu](#) menu.
 - b. Open the [Fax Setup](#) menu.
 - c. Open the [Advanced Setup](#) menu.
 - d. Open the [Fax Resolution](#) menu.
 - e. Select the correct setting.

Fax quality is poor

Fax is blurry or light.

- Increase fax resolution when sending faxes. Resolution does not affect received faxes.
 - a. Open the [Setup Menu](#) menu.
 - b. Open the [Fax Setup](#) menu.
 - c. Open the [Advanced Setup](#) menu.
 - d. Open the [Fax Resolution](#) menu.
 - e. Select the correct setting.



NOTE: Increasing resolution slows transmission speed.

- Turn on the [Error Correction](#) setting from the control panel.
 - a. Open the [Setup Menu](#) menu.
 - b. Open the [Service](#) menu.
 - c. Open the [Fax Service](#) menu.
 - d. Open the [Error Correction](#) menu.
 - e. Select the [On](#) setting.
- Check the toner cartridges and replace if necessary.
- Ask the sender to darken the contrast setting on the sending fax machine, and then resend the fax.

Fax cuts off or prints on two pages

- Set the [Default Paper Size](#) setting. Faxes print on a single size of paper based on the [Default Paper Size](#) settings.
 - a. Open the [Setup Menu](#) menu.
 - b. Open the [System Setup](#) menu.
 - c. Open the [Paper Setup](#) menu.
 - d. Open the [Default Paper Size](#) menu.
 - e. Select the correct setting.
- Set the paper type and size for the tray used for faxes.
- Turn on the [Fit to Page](#) setting to print longer length faxes on letter or A4 size paper.
 - a. Open the [Setup Menu](#) menu.
 - b. Open the [Fax Setup](#) menu.
 - c. Open the [Advanced Setup](#) menu.
 - d. Open the [Fit to Page](#) menu.
 - e. Select the [On](#) setting.



NOTE: If the [Fit to Page](#) setting is off and the [Default Paper Size](#) setting is set to letter, a legal size original prints on two pages.

Solve problems receiving faxes

- [The fax does not respond](#)
- [An error message displays on the control panel](#)
- [A fax is received but does not print](#)
- [Sender receives a busy signal](#)

- [No dial tone](#)
- [Cannot send or receive a fax on a PBX line](#)



The fax does not respond

The fax has a dedicated phone line

- Set the [Answer Mode](#) option to the [Automatic](#) setting from the control panel.
 - a. From the Home screen on the product control panel, touch the Setup  button.
 - b. Open the [Fax Setup](#) menu.
 - c. Open the [Basic Setup](#) menu.
 - d. Open the [Answer Mode](#) menu.
 - e. Select the [Automatic](#) setting.

An answering machine is connected to the product

- Set the [Answer Mode](#) option to the [TAM](#) setting and connect the answering machine to the “telephone” port.
 - a. From the Home screen on the product control panel, touch the Setup  button.
 - b. Open the [Fax Setup](#) menu.
 - c. Open the [Basic Setup](#) menu.
 - d. Open the [Answer Mode](#) menu.
 - e. Select the [TAM](#) setting.



If the [TAM](#) setting is unavailable, set the [Answer Mode](#) option to the [Automatic](#) setting.
- Set the [Rings to Answer](#) setting to at least one ring more than the number of rings for which the answering machine is set.
 - a. From the Home screen on the product control panel, touch the Setup  button.
 - b. Open the [Fax Setup](#) menu.
 - c. Open the [Basic Setup](#) menu.
 - d. Open the [Rings to Answer](#) menu.
 - e. Select the correct setting.
- Connect the answering machine to the “telephone” port.
- If the product has a telephone handset connected, set the [Answer Mode](#) option to the [Fax/Tel](#) setting to route calls to the correct device. When detecting a voice call, the product generates a ring tone that alerts you to pick up the telephone handset.
 - a. From the Home screen on the product control panel, touch the Setup  button.
 - b. Open the [Fax Setup](#) menu.

- c. Open the [Basic Setup](#) menu.
- d. Open the [Answer Mode](#) menu.
- e. Select the [Fax/Tel](#) setting.

The Answer Mode setting is set to the Manual setting

- Touch the [Start Fax](#) button on the product control panel.

Voice mail is available on the fax line

- Add a distinctive ring service to your telephone line and change the [Distinctive Ring](#) setting on the product to match the ring pattern supplied by the telephone company. Contact your telephone company for information.
 - a. From the Home screen on the product control panel, touch the [Setup](#)  button.
 - b. Open the [Fax Setup](#) menu.
 - c. Open the [Basic Setup](#) menu.
 - d. Open the [Distinctive Ring](#) menu.
 - e. Select the correct setting.
- Buy a dedicated line for faxing.
- Set the [Answer Mode](#) option to the [Manual](#) setting.
 - a. From the Home screen on the product control panel, touch the [Setup](#)  button.
 - b. Open the [Fax Setup](#) menu.
 - c. Open the [Basic Setup](#) menu.
 - d. Open the [Answer Mode](#) menu.
 - e. Select the [Manual](#) setting.

 **NOTE:** You must be present to receive faxes.

The product is connected to a DSL phone service

- Check the installation and features. A DSL modem requires a high-pass filter on the phone line connection to the product. Contact your DSL service provider for a filter or buy a filter.
- Verify that the filter is connected.
- Replace the existing filter to make sure that it is not defective.

The product uses a fax over IP or VoIP phone service

- Set the [Fax Speed](#) option to the [Slow\(V.29\)](#) or [Medium\(V.17\)](#) setting.
 - a. From the Home screen on the product control panel, touch the [Setup](#)  button.
 - b. Open the [Fax Setup](#) menu.

- c. Open the [Advanced Setup](#) menu.
 - d. Open the [Fax Speed](#) menu.
 - e. Select the correct setting.
- Contact your service provider to make sure that fax is supported and for a recommended fax speed settings. Some companies might require an adapter.

An error message displays on the control panel

The No Fax Detected message displays



NOTE: This error does not always refer to a missed fax. If a voice call is made to a fax number by mistake and the caller hangs up, the **No Fax Detected** message displays on the control panel.

- Ask the sender to resend the fax.
- Make sure that the telephone cord from the product is connected to the wall telephone jack.
- Try a different phone cord.
- Connect the product phone cord to a jack for another phone line.
- Make sure the telephone line and phone wall jack are active by connecting a telephone and checking for a dial tone.
- Make sure that the telephone cord is connected to the “line” port on the product.
- Check the phone line by running a fax test from the control panel.
- If the error persists, contact HP. See www.hp.com/support/colorljMFPM476 or the support flyer that came in the product box.

The Communication Error message appears

- Ask the sender to send the fax again or send at a later time when line conditions have improved.
- Disconnect the product telephone cord from the wall, connect a telephone to the phone jack on the wall, and try making a call. Plug the product phone cord into a jack for another phone line.
- Try a different phone cord.
- Set the [Fax Speed](#) option to the [Slow\(V.29\)](#) or [Medium\(V.17\)](#) setting.
 - a. From the Home screen on the product control panel, touch the Setup  button.
 - b. Open the [Fax Setup](#) menu.
 - c. Open the [Advanced Setup](#) menu.
 - d. Open the [Fax Speed](#) menu.
 - e. Select the correct setting.
- Turn off the [Error Correction](#) feature to prevent automatic error correction.



NOTE: Turning off the [Error Correction](#) feature can reduce image quality.

- a. From the Home screen on the product control panel, touch the Setup  button.
 - b. Open the [Service](#) menu.
 - c. Open the [Fax Service](#) menu.
 - d. Open the [Error Correction](#) menu.
 - e. Select the [Off](#) setting.
- Print the [Fax Activity Log](#) report from the control panel to determine if the error occurs with a specific fax number.
 - a. Touch the [Fax](#) button, and then touch the [Fax Menu](#) button.
 - b. Open the [Fax Reports](#) menu.
 - c. Open the [Fax Activity Log](#) menu.
 - d. Select the [Print Log Now](#) option.
 - If the error persists, contact HP. See www.hp.com/support/colorljMFP476 or the support flyer that came in the product box.

The Fax storage is full. message appears

- Turn the product off then on.
- Print all of the faxes, and then have the sender resend the fax.
- Ask the sender to divide a large fax job into smaller sections, and then fax them individually.
- Make sure that the resolution of the sending fax machine is not set to the [Photo](#) setting or the [Superfine](#) setting.
 - a. From the Home screen on the product control panel, touch the Setup  button.
 - b. Open the [Fax Setup](#) menu.
 - c. Open the [Advanced Setup](#) menu.
 - d. Open the [Fax Resolution](#) menu.
 - e. Select the correct setting.
- Cancel all fax jobs or clear the faxes from memory.

The Fax is busy. message appears

- The product cannot receive a fax while attempting to send one. Cancel the fax send and try sending at a later time.
- Allow the product to try sending the fax again.

A fax is received but does not print

The Private Receive feature is on

- When the [Private Receive](#) feature is activated, received faxes are stored in memory. A password is required to print the stored faxes.
- Enter the password to print the fax. If you do not know the password, contact the product administrator.



NOTE: Memory errors might occur if the faxes are not printed. The product will not answer if the memory is full.

Sender receives a busy signal

A handset is connected to the product

- Make sure the phone is hung up.
- Change the [Answer Mode](#) option to match the product setup.
 - a. From the Home screen on the product control panel, touch the Setup  button.
 - b. Open the [Fax Setup](#) menu.
 - c. Open the [Basic Setup](#) menu.
 - d. Open the [Answer Mode](#) menu.
 - e. Select the setting that matches the product setup.

Set the [Answer Mode](#) option to the [Fax/Tel](#) setting to automatically receive faxes. The [Fax/Tel](#) setting automatically detects whether the incoming transmission is a fax or a voice call and routes the call to the appropriate device.

A phone line splitter is being used

- If you are using a phone line splitter, remove the splitter and set up the phone as a downstream phone.
- Make sure the phone is hung up.
- Make sure the phone is not being used for a voice call when faxing.

No dial tone

- If using a phone line splitter, remove the phone line splitter and set up the phone as a downstream phone.

Cannot send or receive a fax on a PBX line

- If you are using a PBX phone line, contact your PBX administrator to configure an analog fax line for your product.



Solve problems sending faxes

This section will discuss the following:

- An error message displays on the control panel
- The control panel displays a Ready message with no attempt to send the fax
- The control panel displays the message "Storing page 1" and does not progress beyond that message
- Faxes can be received, but not sent
- Product is password protected
- Unable to use fax functions from the control panel
- Unable to use speed dials
- Unable to use group dials
- Receive a recorded error message from the phone company when trying to send a fax
- Unable to send a fax when a phone is connected to the product

An error message displays on the control panel

The Communication Error message appears

- Allow the product to retry sending the fax. Re-sending temporarily reduces the fax speed.
- Disconnect the product telephone cord from the wall, connect a telephone to the phone jack on the wall, and try making a call. Connect the product phone cord to a jack for another phone line.
- Try a different phone cord.
- From the control panel, change the **Fax Speed** option to the **Medium(V.17)** setting or **Slow(V.29)** setting.
 - From the Home screen on the product control panel, touch the Setup  button.
 - Open the **Fax Setup** menu.
 - Open the **Advanced Setup** menu.
 - Open the **Fax Speed** menu.
 - Select the correct setting.
- Turn off the **Error Correction** option.
 - From the Home screen on the product control panel, touch the Setup  button.
 - Open the **Service** menu.
 - Open the **Fax Service** menu.
 - Open the **Error Correction** menu.
 - Select the **Off** setting.



NOTE: Turning off the **Error Correction** option can reduce image quality.

- If the error persists, contact HP. See www.hp.com/support/colorljMFPM476 or the support flyer that came in the product box.

No dial tone.



- Make sure that the telephone cord is connected to the correct port on the product.
- Make sure that the telephone cord from the product is connected directly to the wall telephone jack.
- Check for a dial tone on the phone line by using the **Start Fax** button.
- Disconnect the product telephone cord from the wall, connect a telephone to the phone jack on the wall, and try making a voice call.
- Disconnect the telephone cord from both the product and the wall and reconnect the cord.
- Make sure that you are using the telephone cord that came with the product.
- Connect the product phone cord to a jack for another phone line.
- Check the phone line by using the **Run Fax Test** option from the **Service** menu on the control panel.
 - a. From the Home screen on the product control panel, touch the Setup  button.
 - b. Open the **Service** menu.
 - c. Open the **Fax Service** menu.
 - d. Select the **Run Fax Test** item.

The Fax is busy. message appears

- Try sending the fax again.
- Call the recipient to ensure that the fax machine is on and ready.
- Check that you are dialing the correct fax number.
- Check for a dial tone on the phone line by using the **Start Fax** button.
- Make sure that the phone line is working by disconnecting the product, connecting a telephone to the phone line, and making a voice call.
- Connect the product phone cord to a jack for another phone line, and try sending the fax again.
- Try a different phone cord.
- Send the fax at a later time.
- If the error persists, contact HP. See www.hp.com/support/colorljMFPM476 or the support flyer that came in the product box.

The No fax answer. message appears

- Try to resend the fax.
- Call the recipient to ensure that the fax machine is on and ready.
- Check that you are dialing the correct fax number.
- Disconnect the product telephone cord from the wall, connect a telephone to the phone jack on the wall, and try making a voice call.
- Connect the product phone cord to a jack for another phone line.

- Try a different phone cord.
- Make sure that the phone cord from the wall telephone jack is connected to the line  port.
- Check the phone line by using the **Run Fax Test** option from the **Service** menu on the control panel.
 - a. From the Home screen on the product control panel, touch the Setup  button.
 - b. Open the **Service** menu.
 - c. Open the **Fax Service** menu.
 - d. Select the **Run Fax Test** item.
- If the error persists, contact HP. See www.hp.com/support/colorljMFP476 or the support flyer that came in the product box.

Document feeder paper jam

- Verify that the paper meets product size requirements. The product does not support pages longer than 381 mm (15 in) for faxing.
- Copy or print the original to letter, A4, or legal size paper, and then resend the fax.

The Fax storage is full. message appears

- Turn the product off then on.
- Print stored faxes that have not been printed.
 - a. Touch the **Fax** button, and then touch the **Fax Menu** button.
 - b. Open the **Receive Options** menu.
 - c. Select the **Print Private Faxes** item.
 - d. Provide the password when the product prompts you.
- Delete stored faxes from memory.
 - a. From the Home screen on the product control panel, touch the Setup  button.
 - b. Open the **Service** menu.
 - c. Open the **Fax Service** menu.
 - d. Select the **Clear Saved Faxes** item.
- Divide the large fax job into smaller sections, and then fax them individually.

Scanner error

- Verify that the paper meets product size requirements. The product does not support pages longer than 381 mm (15 in) for faxing.
- Copy or print the original onto letter, A4, or legal size paper and then resend the fax.

The control panel displays a Ready message with no attempt to send the fax

- Check the fax activity log for errors.

- a. Touch the [Fax](#) button, and then touch the [Fax Menu](#) button.
- b. Open the [Fax Reports](#) menu.
- c. Open the [Fax Activity Log](#) menu.
- d. Select the [Print Log Now](#) option.
- If a phone is connected to the product, make sure that the phone is hung up.
- Disconnect all other lines between the fax and the product.
- Connect the product directly into the wall telephone jack and resend the fax.

The control panel displays the message "Storing page 1" and does not progress beyond that message

- Delete stored faxes from memory.
 - a. From the Home screen on the product control panel, touch the Setup  button.
 - b. Open the [Service](#) menu.
 - c. Open the [Fax Service](#) menu.
 - d. Select the [Clear Saved Faxes](#) item.

Faxes can be received, but not sent

Send fax and nothing happens.

1. Check for a dial tone on the phone line by using the [Start Fax](#) button.
2. Turn the product off then on.
3. Use the control panel or the HP Fax Setup Wizard to configure the fax time, date, and fax header information.
 - a. From the Home screen on the product control panel, touch the Setup  button.
 - b. Open the [Fax Setup](#) menu.
 - c. Open the [Basic Setup](#) menu.
 - d. Open the [Fax Header](#) menu.
 - e. Enter the correct settings.
4. Verify that any extension phones on the line are hung up.
5. If using a DSL service, make sure that the phone line connection to the product includes a high-pass filter.

Product is password protected

If a network administrator has set a product password, then you must obtain the password in order to use the product fax features.

Unable to use fax functions from the control panel

- The product might be password protected. Use the HP Embedded Web Server, HP Toolbox software, or the control panel to set a password.
- If you do not know the password for the product, contact your system administrator.
- Verify with the system administrator that the fax functionality has not been disabled.

Unable to use speed dials

- Make sure that the fax number is valid.
- If an outside line requires a prefix, turn on the [Dial Prefix](#) option or include the prefix in the speed dial number.
 - a. From the Home screen on the product control panel, touch the Setup  button.
 - b. Open the [Fax Setup](#) menu.
 - c. Open the [Basic Setup](#) menu.
 - d. Open the [Dial Prefix](#) menu.
 - e. Select the [On](#) setting.

Unable to use group dials

- Make sure that the fax number is valid.
- If an outside line requires a prefix, turn on the [Dial Prefix](#) option or include the prefix in the speed dial number.
 - a. From the Home screen on the product control panel, touch the Setup  button.
 - b. Open the [Fax Setup](#) menu.
 - c. Open the [Basic Setup](#) menu.
 - d. Open the [Dial Prefix](#) menu.
 - e. Select the [On](#) setting.
- Set up all entries in the group with speed dial entries.
 - a. Open an unused speed dial entry.
 - b. Enter the fax number for the speed dial.
 - c. Touch the [OK](#) button to save the speed dial.

Receive a recorded error message from the phone company when trying to send a fax

- Make sure you dial the fax number correctly, and make sure that the phone service is not blocked. For example, some phone services might prevent long distance calling.
- If an outside line requires a prefix, turn on the [Dial Prefix](#) option or include the prefix in the speed dial number.

- a. From the Home screen on the product control panel, touch the Setup  button.
- b. Open the [Fax Setup](#) menu.
- c. Open the [Basic Setup](#) menu.
- d. Open the [Dial Prefix](#) menu.
- e. Select the [On](#) setting.

 **NOTE:** To send a fax without a prefix, when the [Dial Prefix](#) option is turned on, send the fax manually.

- Send a fax to an international number
 - a. If a prefix is required, manually dial the telephone number with the prefix.
 - b. Enter the country/region code before dialing the phone number.
 - c. Wait for pauses as you hear the tones on the phone.
 - d. Send the fax manually from the control panel.

Unable to send a fax when a phone is connected to the product

- Make sure that the telephone is hung up.
- Make sure that the telephone is not being used for a voice call when faxing.
- Disconnect the phone from the line, and then try sending the fax.

Fax trace report

A fax T.30 trace report has information that can help resolve fax transmission problems. If you call HP for help in resolving these problems, print a T.30 trace report before you call.

1. From the Home screen on the product control panel, touch the Setup  button.
2. Touch the [Service](#) menu.
3. Touch the [Fax Service](#) menu.
4. Touch the [Print T.30 Trace](#) button, and then touch the [Now](#) button.



NOTE: This procedure prints a report for the last fax job, successful or not. To generate a report for each unsuccessful fax job, select the [If Error](#) setting. To generate a report for each fax job, select the [At End of Call](#) setting.

Fax error report printing

Use the following instructions to print fax logs and reports:

Print all fax reports

Use this procedure to print all of the following reports at one time:

- Last Call Report
- Fax Activity Log
- Phone Book Report
- Junk Fax List
- Billing Report (when Billing Codes are turned on)
- Configuration Report
- Usage Page

1. From the Home screen on the product control panel, touch the [Fax](#) button.
2. Touch the [Fax Menu](#) button.
3. Touch the [Fax Reports](#) button.
4. Touch the [Print All fax Reports](#) button.

Print individual fax reports

1. From the Home screen on the product control panel, touch the [Fax](#) button.
2. Touch the [Fax Menu](#) button.
3. Touch the [Fax Reports](#) button.
4. Touch the name of the report that you want to print.

Set the fax error report

A fax error report is a brief report that indicates the product experienced a fax job error. You can set it to print after the following events:

- Every fax error (the factory-set default)
- Send fax error
- Receive fax error
- Never



NOTE: With this option, you will have no indication that a fax failed to be transmitted unless you print a fax activity log.

1. From the Home screen on the product control panel, touch the **Fax** button.
2. Touch the **Fax Menu** button.
3. Touch the **Fax Reports** button.
4. Touch the **Fax Error Report** button, and then touch the printing option that you want to use.

Set the fax-error-correction mode

Usually, the product monitors the signals on the telephone line while it is sending or receiving a fax. If the product detects an error during the transmission and the error-correction setting is **On**, the product can request that the portion of the fax be resent. The factory-set default for error correction is **On**.

You should turn off error correction only if you are having trouble sending or receiving a fax, and you are willing to accept the errors in the transmission. Turning off the setting might be useful when you are trying to send a fax overseas or receive one from overseas, or if you are using a satellite telephone connection.

1. From the Home screen on the product control panel, touch the **Setup**  button.
2. Touch the **Service** menu.
3. Touch the **Fax Service** menu.
4. Touch the **Error Correction** button, and then touch the **On** button.

Change the fax speed

The fax-speed setting is the modem protocol that the product uses to send faxes. It is the worldwide standard for full-duplex modems that send and receive data across telephone lines at up to 33,600 bits per second (bps). The factory-set default for the fax-speed setting is **Fast(V.34)**.

You should change the setting only if you are having trouble sending a fax to or receiving a fax from a particular device. Decreasing the fax speed might be useful when you are trying to send a fax overseas, or receive one from overseas, or if you are using a satellite telephone connection.

1. From the Home screen on the product control panel, touch the **Setup**  button.
2. Touch the **Fax Setup** menu.
3. Touch the **Advanced Setup** menu.
4. Scroll to and touch the **Fax Speed** button, and then touch the speed setting that you want to use.

Solve email problems

If [Scan to E-mail](#) problems occur, try these solutions:

- Make sure this feature has been set up. If this feature has not been set up, use the setup wizard in the HP Device Toolbox (Windows) or HP Utility for Mac OS X software to set it up.
- Make sure the Scan to Email feature is enabled. If it has been disabled, enable the feature through the HP Device Toolbox (Windows) or HP Utility for Mac OS X software.
- Make sure the product is connected to a computer or to a network.

Cannot connect to the email server

- Make sure the SMTP server name is correct. Check this setting with your system administrator or Internet Service Provider.
- If the product cannot establish a secure connection to the SMTP server, try without the secure connection or try a different server or port. Check this setting with your system administrator or Internet Service Provider.
- If the SMTP server requires authentication, make sure a valid user name and password are used.
- If the SMTP server uses an authentication method that is not supported, try a different server. Check this setting with your system administrator or Internet Service Provider.

The email failed

- Verify that email addresses entered are correct.
- If the size of the email was too large, send fewer pages or reduce the scan resolution.

Unable to scan

- If you are prompted for a PIN, enter the correct PIN for the outgoing profile.
- Make sure at least one email address is selected in the [To](#) field.

Validate LDAP gateway

The LDAP implementation enables an administrator to configure and setup the LDAP feature using the product's Embedded Web Server or Web JetAdmin. There are no provisions for configuring LDAP using the product control panel, Telnet, or PMS/SNMP.

Access control for LaserJet Pro devices

The concepts of Authentication versus Authorization are linked yet distinct. You can't have one without the other.

- Authentication is the act of determining “who” is standing at the control panel.
- Authorization is the act of enforcing “what” that person is allowed to do.

The HP LaserJet Pro LDAP solution brings both, and together the set provides “Access Control” to the device.

The HP LaserJet Pro LDAP feature provides both and yet is a subset of what the HP LaserJet Enterprise devices offer. The HP LaserJet Pro solution can allow up to 8 functions to be restricted from public access. Each restricted function will allow a user to sign in with either their network user name and password, or sign in with the single 4- to 8-digit access code assigned to the device.

Product resets

Restore the factory-set defaults

Restoring the factory-set defaults returns most of the settings to the factory defaults. It will not reset the page count or tray size, but it might reset the language. To restore the product to the factory-default settings, follow these steps.

1. **Touchscreen control panels:** Touch the Setup Setup  button to open the Setup menu.
2. Open the **Service** menu.
3. Select the **Restore defaults** item, and then press the **OK** button.

The product automatically restarts.

NVRAM initialization

 **CAUTION:** All HP Jetdirect settings are also reset. Be sure to print a configuration page before performing an NVRAM initialization. Make note of the IP address that is listed on the Jetdirect configuration page. You need to restore the IP address after performing an NVRAM initialization.

An NVRAM initialization erases all data stored in the unprotected NVRAM sections. Performing an NVRAM initialization resets the following settings and information:

- All menu settings are reset to factory default values.
- All localization settings, including language and country/region, are reset.

After performing an NVRAM initialization, reconfigure any computers that print to this product so that the computers can recognize the product.

1. Turn the product off.
2. Press and hold the lower right quadrant of the touchscreen. Keep the quadrant depressed as you turn the product on.
3. When the **Permanent Storage Init.** message appears on the display, release the buttons.
4. When the product has finished the NVRAM initialization, it returns to the Ready state.

Super NVRAM initialization

A super NVRAM initialization restores the product to the “generic product mode” in which it arrived from the factory. This means that you will have to reset the language and country/region settings when the product starts after the initialization. A super NVRAM initialization erases all data stored in the protected and unprotected NVRAM sections.

1. Turn the product off.
2. Press and hold the lower left quadrant of the touchscreen. Keep the quadrant depressed as you turn the product on.
3. When the **Permanent Storage Init.** message appears on the display, release the buttons.
4. When the super NVRAM initialization has been completed, the product enters the generic product mode.

Firmware upgrades

Use the following references to update the product firmware, depending on your configuration:

- *HP LaserJet Enterprise and HP LaserJet Enterprise MFP - Update firmware using a USB flash drive or the Embedded Web Server (EWS)* (Ref: c03847902)
- *HP LaserJet Enterprise Printers and MFPs - Update firmware using Web Jetadmin* (Ref: c03840402)

www.hp.com/support/colorljMFPM476

A Product specifications

- [Product dimensions](#)
- [Power consumption, electrical specifications, and acoustic emissions](#)
- [Environmental specifications](#)
- [Certificate of Volatility](#)

Product dimensions

Table A-1 Physical specifications

Product	Height	Depth	Width	Weight
M476nw	499 mm (19.6 in)	470 mm (18.5 in)	420 mm (16.5 in)	28.2 kg (62 lb)
M476dw, M476dn	499 mm (19.6 in)	484 mm (19.1 in)	420 mm (16.5 in)	29.3 kg (64.5 lb)

Power consumption, electrical specifications, and acoustic emissions

See www.hp.com/go/lj400mfpM476nw_regulatory-environmental or www.hp.com/go/lj400mfpM476dn_regulatory-environmental for current information.

CAUTION: Power requirements are based on the country/region where the product is sold. Do not convert operating voltages. This will damage the product and void the product warranty.

Environmental specifications

Table A-2 Operating-environment specifications

Environment	Recommended	Allowed
Temperature	17° to 25°C (62.6° to 77°F)	15° to 30°C (59° to 86°F)
Relative humidity	30% to 70% relative humidity (RH)	10% to 80% RH
Altitude	Not applicable	0 to 3048 m (0 to 10,000 ft)

Certificate of Volatility

Figure A-1 Certificate of Volatility (1 of 2)

Hewlett-Packard Certificate of Volatility				
Model: HP Color LaserJet Pro MFP M476 Printer series		Part Number: M476nw – CF385A M476dn – CF386A M476dw – CF387A		Address: Hewlett Packard Company 11311 Chinden Blvd Boise, ID 83714
Volatile Memory				
Does the device contain volatile memory (Memory whose contents are lost when power is removed)? <input checked="" type="checkbox"/> Yes <input type="checkbox"/> No If Yes please describe the type, size, function, and steps to clear the memory below				
Type (SRAM, DRAM, etc): DDR	Size: 256 MB	User Modifiable: <input type="checkbox"/> Yes <input checked="" type="checkbox"/> No	Function: Used for temporary storage during the process of jobs, and for applications that are running on the OS.	Steps to clear memory: When the printer is powered off, the memory is erased.
Type (SRAM, DRAM, etc):	Size:	User Modifiable: <input type="checkbox"/> Yes <input type="checkbox"/> No	Function:	Steps to clear memory:
Type (SRAM, DRAM, etc):	Size:	User Modifiable: <input type="checkbox"/> Yes <input type="checkbox"/> No	Function:	Steps to clear memory:
Non-Volatile Memory				
Does the device contain non-volatile memory (Memory whose contents are retained when power is removed)? <input checked="" type="checkbox"/> Yes <input type="checkbox"/> No If Yes please describe the type, size, function, and steps to clear the memory below				
Type (Flash, EEPROM, etc): EEPROM	Size: 128kb	User Modifiable: <input type="checkbox"/> Yes <input checked="" type="checkbox"/> No	Function: Device configuration, page statistics.	Steps to clear memory: n/a
Type (Flash, EEPROM, etc): Flash	Size: 2 Gb	User Modifiable: <input type="checkbox"/> Yes <input checked="" type="checkbox"/> No	Function: Device FW, fax file system	Steps to clear memory: n/a
Type (Flash, EEPROM, etc): None	Size:	User Modifiable: <input type="checkbox"/> Yes <input checked="" type="checkbox"/> No	Function:	Steps to clear memory:
Mass Storage				
Does the device contain mass storage memory (Hard Disk Drive, Tape Backup)? <input type="checkbox"/> Yes <input checked="" type="checkbox"/> No If Yes please describe the type, size, function, and steps to clear the memory below				
Type (HDD, Tape, etc):	Size:	User Modifiable: <input type="checkbox"/> Yes <input type="checkbox"/> No	Function:	Steps to clear memory:

Figure A-2 Certificate of Volatility (2 of 2)

Type (HDD, Tape, etc):	Size:	User Modifiable: <input type="checkbox"/> Yes <input type="checkbox"/> No	Function:	Steps to clear memory:
USB				
Does the item accept USB input and if so, for what purpose (i.e Print Jobs, device firmware updates, scan upload)? <input checked="" type="checkbox"/> Yes <input type="checkbox"/> No If Yes please describe below				
Description: Print jobs, scan to USB thumb drive, device firmware updates. USB can be disabled.				
Can any data other than scan upload be sent to the USB device? <input type="checkbox"/> Yes <input checked="" type="checkbox"/> No If Yes please describe below				
RF/RFID				
Does the item use RF or RFID for receive or transmit of any data including remote diagnostics. (e.g. Cellular phone, Bluetooth) <input checked="" type="checkbox"/> Yes <input type="checkbox"/> No If Yes please describe below				
Purpose: Wireless information string.				
Frequency: 13.56 MHz		Bandwidth: 106 – 848kbps		
Modulation: 7-30%		Effective Radiate Power (ERP): Not an intentional radiator. Load modulation as passive tag emulation.		
Specifications:				
Other Transmission Capabilities				
Does the device employ any other methods of non-wired access to transmit or receive any data whatsoever (e.g. anything other than standard hard wired TCP/IP, direct USB, or parallel connections)? <input checked="" type="checkbox"/> Yes <input type="checkbox"/> No If Yes please describe below:				
Purpose: Wirelss network connectivity				
Frequency: 2.4 GHz		Bandwidth: 802.11n 20 Mhz		
Modulation:		Effective Radiate Power (ERP): 802.11n 15+-1.5dBm		
Specifications: 802.11n/a/b/g				
Other Capabilities				
Does the device employ any other method of communications such as a Modem to transmit or receive any data whatsoever? <input checked="" type="checkbox"/> Yes <input type="checkbox"/> No If Yes please describe below:				
Purpose: Fax modem for receipt and sending of faxes				
Specifications: 33.6 kbs				
Author Information				
Name: Debbie Tuckness	Title: Technical Marketing Engineer	Email: Debbie.tuckness@hp.com	Business Unit: IPG	
				Date Prepared: 01-15-14

Index

A

- ACL (advanced control language) 6
- acoustic specifications 162
- ADF
 - duplex operation 30
 - jam 31
 - jam clearance 32
 - jam detection 31
 - operation 30
 - paper path 30
 - paper-present sensor 30, 31
 - sensors 30
- advanced control language (ACL) 6

B

- background shading,
 - troubleshooting 121
- bands and streaks,
 - troubleshooting 121
- bands, troubleshooting 109
- billing filters
 - fax 37
 - tone 37
- blank pages, troubleshooting 107, 131

C

- cables
 - USB, troubleshooting 131
- calibrate
 - colors 117
- cartridges
 - drum rotation check 47
 - image-formation system 16
 - supplies status page 66
- cautions iii
- characters, troubleshooting 111, 122

- checklist
 - fax troubleshooting 139
 - problem source 44
 - wireless connectivity 136
- checks
 - drum rotation 47
 - half self-test 48
- circuit diagram 57
- clean
 - touchscreen 130
- cleaning
 - glass 115, 128
 - paper path 115, 128
- cleaning stage
 - drum 22
 - ITB 21
- CO operations 33
- color
 - troubleshooting 110
- color options
 - changing, Windows 118
- color theme
 - changing, Windows 118
- color usage log 66
- colors
 - calibrate 117
- components 2
 - diagram 50
- configuration page 46, 66
- configuration report 43
- control panel
 - clean touchscreen 130
 - cleaning page, printing 128
 - Copy menu 77
 - demo page, printing 66
 - doesn't illuminate 40
 - Fax menu 75
 - fax reports, printing 66
 - Fax Setup menu 67

- HP Web Services menu 65
- menu map, printing 66
- menus 65
- message types 78
- messages, troubleshooting 79
- Network Setup menu 74
- Quick Forms menu 75
- Reports menu 66
- Self Diagnostics menu 66
- Service menu 72
- Setup menu 65
- System Setup menu 69
- controls
 - hook switch control 36
- conventions, document iii
- Copy menu
 - control panel 77
- copying
 - sequence 28
- creases, troubleshooting 111, 123
- crooked pages 123
 - troubleshooting 111
- curled paper 123
- current control, fax line 36

D

- dark image, troubleshooting 107
- data path
 - fax 35
- DC controller
 - engine control system 7
 - laser/scanner system
 - operations 15
 - pickup-and-feed system
 - operations 23
- default settings, restoring
 - NVRAM initialization 158
- defaults
 - restoring 158

- demo page 46
- developing stage 18
- device
 - downstream detection, fax 36
- diagrams
 - troubleshooting 50
- dialing
 - pulse 36
- distinctive ring 34
- document conventions iii
- document feeder
 - jams 97
- dots, troubleshooting 120
- downstream device detection
 - fax 36
- drive components
 - diagrams 50
- drivers
 - usage page 66
- drum
 - rotation functional check 47
- drum, image formation operations 17

E

- EconoMode setting 117
- electrical specifications 162
- engine control
 - DC controller 8
- error messages
 - control panel 79
 - error report 92
 - event log 92
- error messages, fax 142, 147
- error report, fax
 - printing 155
- error-correction setting, fax 155
- event log 46

F

- factory defaults, restoring
 - NVRAM initialization 158
- faded print 107, 120
- fans
 - location 52
- fax
 - billing (metering) tone filters 37
 - card 35
 - data path 35
 - distinctive ring 34

- downstream current detection 36
- error report, printing 155
- error-correction 155
- flash memory storage 37
- functions 33
- hook state 36
- hook switch control 36
- line current control 36
- operations 33
- page storage 37
- PSTN operations 33
- pulse dialing 36
- receiving 33
- reports, printing all 154
- ring detect 36
- safety isolation 35
- safety protection circuitry 35
- solve general problems 140
- subsystem 35
- unable to receive 142
- unable to send 147
- V.34 setting 155
- voice over IP (VoIP) services 34
- fax card
 - CODEC 35
 - DSP 35
 - fax subsystem 35
 - hook switch control 36
 - pulse dialing 36
 - regional versions 35
 - ring detect 36
- Fax menu
 - control panel 75
- fax ports, locating 49
- fax security
 - security features, computer 33
 - security features, network 33
- Fax Setup menu
 - control panel 67
- fax subsystem
 - fax card 35
 - operations 35
- fax troubleshooting
 - checklist 139
- flash memory, fax 37
- fonts
 - lists, printing 66
- formatter connections
 - locating 49

- fuser
 - assembly diagrams 50
- fuser control 10
- fusing stage 20

G

- glass, cleaning 115, 128
- gray background, troubleshooting 121

H

- half self-test check 48
- high-voltage power supply 14
- hook state
 - fax 36
- hook switch control 36
- HP Jetdirect print server
 - NVRAM initialization 158
- HP Web Services menu
 - control panel 65

I

- image formation
 - cleaning stage 22
 - developing stage 18
 - fusing stage 20
 - latent-image stage 17
 - process 16
 - systems 16
 - transfer stage 19
- image quality
 - troubleshooting defects 64
- image quality issues
 - examples and solutions 107
- image transfer stage 19
- image-formation system
 - testing 48
- initialization
 - NVRAM 158
- interface ports
 - locating 49
- ITB
 - assembly diagrams 50

J

- jam detection
 - detection operations 25
- jams
 - causes of 95
 - document feeder, clearing 97
 - tracking number of 66

- Jetdirect print server
 - NVRAM initialization 158
- L**
- laser
 - beam exposure stage 18
 - scanner system operations 15
- latent-image formation stage 17
- LDAP gateway
 - validating 157
- LEDM (low-end data model) 6
- LEDs, troubleshooting 46
- light print, troubleshooting 107, 120
- lightness
 - faded print, troubleshooting 120
- line current control, fax 36
- lines, troubleshooting 109, 121
 - printed pages 121
- logs, fax
 - error 155
 - printing all 154
- loose toner, troubleshooting 110, 122
- low-end data model (LEDM) 6
- M**
- media
 - feed stage 19
 - jam detection operations 25
- memory
 - flash, fax 37
 - NVRAM initialization 158
- menu structure
 - printing 42
- menus, control panel
 - demo page, printing 66
 - fax reports, printing 66
 - map, printing 66
- messages
 - control panel 79
- motors
 - doesn't rotate 40
 - location 52
- N**
- network
 - configuring 74
- network port
 - locating 49
- Network Setup menu
 - control panel 74
- networks
 - configuration page 66
 - security features 33
 - settings report 66
- notes iii
- NVRAM initialization 158
- O**
- off-hook 36
- on-hook 36
- operations
 - engine control system 3
 - fax 33
 - fax card in subsystem 35
 - fax subsystem 35
 - fax, PSTN 33
 - image-formation system 16
 - jam detection 25
 - laser/scanner system 15
 - pickup-and-feed system 23
 - product systems 7
 - PSTN 33
 - scanning and image capture system 27
 - sequence of 3
- P**
- page count 66
- pages
 - blank 131
 - not printing 131
 - printing slowly 131
 - skewed 111, 123
- paper
 - curled, troubleshooting 123
 - jam detection operations 25
 - jams 95
 - selecting 116
 - wrinkled 111, 123
- paper jams. *See* jams
- paper pickup problems
 - solving 106
- PCAs, diagrams 54
- PCL font list 66
- photosensitive drum
 - image formation operations 17
 - rotation functional checks 47
- pickup roller
 - locating 53
- pickup-and-feed system
 - operations 23
- ports
 - locating 49
- power
 - consumption 162
 - fax line current control 36
 - supplies diagrams 50
 - troubleshooting 40
- power failure 40
- power saving 10
- power supply 9
 - protective function 9
- power-on
 - scanner sequence 27
- power-on checks 45
- primary charging stage 17
- print cartridges
 - image-formation system 16
- print quality troubleshooting tools
 - image defects table 107
 - repetitive image defect ruler 64
- printing
 - troubleshooting 131
- problem-solving
 - no response 132
 - slow response 133
- product
 - fax, functions 33
 - operation sequence 3, 8
- protocol settings, fax 155
- PS font list 66
- PSTN operations 33
- pulse dialing 36
- Q**
- quality
 - troubleshooting repetitive image defects 64
- quick forms
 - printing 75
- Quick Forms menu
 - control panel 75
- R**
- receiving faxes 33
 - distinctive ring 34
 - error report, printing 155

- regional versions
 - fax card 35
 - repetitive defects, troubleshooting 64, 124
 - reports
 - color usage log 66
 - configuration report 43, 66
 - default info page 66
 - Demo Page 66
 - diagnostics page 66
 - error 92
 - fax 66
 - menu structure 66
 - network summary 66
 - PCL font list 66
 - PCL6 font list 66
 - print quality page 66
 - PS font list 66
 - service page 66
 - supplies status 66
 - usage page 66
 - Reports menu
 - control panel 66
 - reports, fax
 - error 155
 - printing all 154
 - resets
 - NVRAM initialization 158
 - restoring
 - factory defaults 158
 - restoring default settings
 - NVRAM initialization 158
 - ring detect
 - fax card 36
 - RING operations 33
 - rollers
 - image formation operations 17
 - locating 53
 - rotation check, drum 47
- S**
- safety
 - protection circuitry, fax 35
 - isolation, fax 35
 - scanner
 - glass cleaning 115, 128
 - scanner operation 28
 - scatter, troubleshooting 124
 - security features
 - computer 33
 - network 33
 - Self Diagnostics menu
 - control panel 66
 - sending faxes
 - error report, printing 155
 - sensors
 - jam detection 25
 - separation rollers
 - locating 53
 - separation stage, image formation 20
 - sequence of operations 3
 - Service menu
 - control panel 72
 - service page 66
 - settings
 - network report 66
 - Setup menu
 - accessing 65
 - skewed pages 123
 - troubleshooting 111
 - smearred toner, troubleshooting 111, 121
 - solve
 - fax problems 147
 - solve problems 39
 - fax 140
 - specifications
 - electrical and acoustic 162
 - specks, troubleshooting 120
 - spots, troubleshooting 120
 - status
 - supplies, printing report 66
 - status page 46
 - storing
 - fax pages in flash memory 37
 - streaks, troubleshooting 109, 121
 - supplies status 113
 - supplies status page 66
 - System Setup menu
 - control panel 69
 - systems 7
 - major 2
- T**
- table, repetitive defect 64
 - tests
 - drum rotation 47
 - half self-test check 48
 - text, troubleshooting 111, 122
 - timing diagram 56
 - TIP operations 33
 - tips iii
 - toner
 - loose, troubleshooting 110, 122
 - scatter, troubleshooting 124
 - smearred, troubleshooting 111, 121
 - specks, troubleshooting 120
 - toner cartridge
 - checking for damage 116
 - toner cartridges
 - supplies status page 66
 - toner-cartridge status 113
 - touchscreen, clean 130
 - transfer stage 19
 - Tray 1
 - clear jams 98
 - Tray 2
 - clear jams 100
 - Tray 3
 - clear jams 101
 - troubleshooting 39
 - basic steps 40
 - blank pages 131
 - checklist 40
 - configuration page 46
 - configuration report 43
 - control panel messages 79
 - control-panel checks 45
 - curled paper 123
 - demo page 46
 - diagrams 50
 - drum rotation check 47
 - duplexing 127
 - event log 46
 - faded print 120
 - fax error-correction setting 155
 - faxes 139
 - half self-test 48
 - image formation 48
 - jams 95
 - LED diagnostics 46
 - lines, printed pages 109, 121
 - loose toner 122
 - network problems 134

- NVRAM initialization 158
- pages not printing 131
- pages printing slowly 131
- power 40
- problem source 44
- receive fax 142
- repetitive defects 124
- reports and tools 46
- send fax 147
- skewed pages 111, 123
- status page 46
- text 111, 122
- toner scatter 124
- toner smear 111, 121
- toner specks 120
- USB cables 131
- USB connection 134
- wired network 134
- wireless network 135
- wrinkles 111, 123
- troubleshooting tools
 - control panel LEDs 46
 - drum rotational check 47
 - Engine diagnostics 47
 - half self-test check 48
 - network LEDs 46

U

- usage page 66
- USB connection
 - troubleshooting 134
- USB port
 - locating 49
 - troubleshooting 131

V

- V.34 setting 155
- vertical lines, troubleshooting 109, 121
- voice over IP (VoIP) services 34

W

- warnings iii
- wavy paper, troubleshooting 123
- Web Services menu
 - control panel 65
- white spots, troubleshooting 108
- wireless network
 - troubleshooting 135
- wireless network interference 138
- wrinkles, troubleshooting 111, 123

