



# **CX510 Series**

---

## **User's Guide**

**September 2014**

**[www.lexmark.com](http://www.lexmark.com)**

---

Machine type(s):

7527

Model(s):

636, 637

# Contents

- Safety information.....7**
- Learning about the printer.....9**
  - Finding information about the printer.....9
  - Selecting a location for the printer.....10
  - Printer configurations.....11
  - Understanding the basic functions of the scanner.....12
  - Using the ADF and scanner glass.....13
- Understanding the printer control panel.....14**
  - Using the printer control panel.....14
  - Understanding the home screen.....14
  - Understanding the colors of the Sleep button and indicator lights.....16
  - Using the touch-screen buttons.....17
- Setting up and using the home screen applications.....19**
  - Finding the IP address of the computer.....19
  - Finding the IP address of the printer.....19
  - Accessing the Embedded Web Server.....19
  - Customizing the home screen.....20
  - Understanding the different applications.....20
  - Activating the home screen applications.....21
    - Finding information about the home screen applications.....21
    - Setting up Forms and Favorites .....21
    - Setting up Card Copy .....22
    - Using MyShortcut .....22
    - Setting up Multi Send .....23
    - Setting up Scan to Network .....23
  - Setting up Remote Operator Panel.....24
  - Exporting and importing a configuration.....25
- Additional printer setup.....26**
  - Installing internal options.....26
  - Installing hardware options.....32
  - Attaching cables.....35
  - Setting up the printer software.....36

Networking.....37  
 Verifying printer setup.....41

**Loading paper and specialty media.....42**

Setting the paper size and type.....42  
 Configuring Universal paper settings.....42  
 Loading the 250- and 550-sheet tray.....42  
 Loading the manual feeder.....45  
 Loading the 650-sheet duo tray.....46  
 Loading the multipurpose feeder.....47  
 Linking and unlinking trays.....49

**Paper and specialty media guide.....52**

Using specialty media.....52  
 Paper guidelines.....55  
 Supported paper sizes, types, and weights.....58

**Printing.....62**

Printing forms.....62  
 Printing a document.....62  
 Printing from a flash drive or mobile device.....64  
 Printing confidential and other held jobs.....66  
 Printing information pages.....68  
 Canceling a print job.....68

**Copying.....69**

Making copies.....69  
 Copying photos.....70  
 Copying on specialty media.....70  
 Creating a copy shortcut using the printer control panel.....71  
 Customizing copy settings.....72  
 Placing information on copies.....77  
 Canceling a copy job.....78  
 Understanding the copy options.....78

**E-mailing.....82**

Setting up the printer to e-mail.....82  
 Creating an e-mail shortcut.....83

E-mailing a document.....	84
Customizing e-mail settings.....	85
Canceling an e-mail.....	86
Understanding the e-mail options.....	86
<b>Faxing.....</b>	<b>89</b>
Setting up the printer to fax.....	89
Sending a fax.....	103
Creating shortcuts.....	106
Customizing fax settings.....	106
Canceling an outgoing fax.....	108
Holding and forwarding faxes.....	108
Understanding the fax options.....	109
<b>Scanning.....</b>	<b>112</b>
Using Scan to Network.....	112
Scanning to an FTP address.....	112
Scanning to a computer or flash drive.....	114
Understanding the scan options.....	116
<b>Understanding the printer menus.....</b>	<b>119</b>
Menus list.....	119
Supplies menu.....	120
Paper menu.....	120
Reports menu.....	130
Network/Ports.....	131
Security menu.....	139
Settings menu.....	145
<b>Saving money and the environment.....</b>	<b>195</b>
Saving paper and toner.....	195
Saving energy.....	196
Recycling.....	199
<b>Securing the printer.....</b>	<b>201</b>
Using the security lock feature.....	201
Statement of Volatility.....	201
Erasing volatile memory.....	202

Erasing non-volatile memory.....202

Erasing printer hard disk memory.....203

Configuring printer hard disk encryption.....203

Finding printer security information.....204

**Maintaining the printer.....205**

Cleaning printer parts.....205

Checking the status of parts and supplies.....207

Estimated number of remaining pages.....207

Ordering supplies.....208

Storing supplies.....210

Replacing supplies.....211

Moving the printer.....230

**Managing the printer.....232**

Finding advanced networking and administrator information.....232

Checking the virtual display.....232

Setting up e-mail alerts.....232

Viewing reports.....232

Configuring supply notifications from the Embedded Web Server.....233

Copying printer settings to other printers.....234

Restoring factory default settings.....234

**Clearing jams.....235**

Avoiding jams.....235

Understanding jam messages and locations.....236

[x]-page jam, clear standard bin [203.xx].....237

[x]-page jam, open front door to clear fuser [20y.xx].....240

[x]-page jam, open front door [20y.xx].....243

[x]-page jam, open front door to clear duplex [23y.xx].....244

[x]-page jam, open tray [x] [24y.xx].....245

[x]-page jam, clear manual feeder [251.xx].....246

[x]-page jam, clear multipurpose feeder [250.xx].....247

[x]-page jam, open automatic feeder top cover [28y.xx].....249

**Troubleshooting.....250**

Understanding the printer messages.....250

Solving printer problems.....264

Solving print problems.....270

Solving copy problems.....297

Solving fax problems.....300

Solving scanner problems.....307

Solving home screen application problems.....311

Embedded Web Server does not open.....311

Contacting customer support.....313

**Notices.....314**

Product information.....314

Edition notice.....314

Power consumption.....318

**Index.....331**

## Safety information

Connect the power cord directly to an appropriately rated and properly grounded electrical outlet that is near the product and easily accessible.

 **CAUTION—POTENTIAL INJURY:** Do not use this product with extension cords, multioutlet power strips, multioutlet extenders, or other types of surge or UPS devices. The power rating capacity of these types of accessories can be easily overloaded by a laser printer and may result in poor printer performance, property damage, or potential fire.

Do not place or use this product near water or wet locations.

 **CAUTION—POTENTIAL INJURY:** This product uses a laser. Use of controls or adjustments or performance of procedures other than those specified herein may result in hazardous radiation exposure.

This product uses a printing process that heats the print media, and the heat may cause the media to release emissions. You must understand the section in your operating instructions that discusses the guidelines for selecting print media to avoid the possibility of harmful emissions.

 **CAUTION—HOT SURFACE:** The inside of the printer might be hot. To reduce the risk of injury from a hot component, allow the surface to cool before touching.

 **CAUTION—POTENTIAL INJURY:** The lithium battery in this product is not intended to be replaced. There is a danger of explosion if a lithium battery is incorrectly replaced. Do not recharge, disassemble, or incinerate a lithium battery. Discard used lithium batteries according to the manufacturer's instructions and local regulations.

 **CAUTION—POTENTIAL INJURY:** The printer weight is greater than 18 kg (40 lb) and requires two or more trained personnel to lift it safely.

 **CAUTION—POTENTIAL INJURY:** Before moving the printer, follow these guidelines to avoid personal injury or printer damage:

- Turn the printer off using the power switch, and then unplug the power cord from the electrical outlet.
- Disconnect all cords and cables from the printer before moving it.
- Lift the printer off the optional tray, and then set it aside instead of trying to lift the tray and printer at the same time.

**Note:** Use the handholds located on both sides of the printer to lift it.

Use only the power cord provided with this product or the manufacturer's authorized replacement.

Use only the telecommunications (RJ-11) cord provided with this product or a 26 AWG or larger replacement when connecting this product to the public switched telephone network.

 **CAUTION—SHOCK HAZARD:** If you are accessing the controller board or installing optional hardware or memory devices sometime after setting up the printer, then turn the printer off, and unplug the power cord from the electrical outlet before continuing. If you have any other devices attached to the printer, then turn them off as well, and unplug any cables going into the printer.

 **CAUTION—SHOCK HAZARD:** Make sure that all external connections (such as Ethernet and telephone system connections) are properly installed in their marked plug-in ports.

This product is designed, tested, and approved to meet strict global safety standards with the use of specific manufacturer's components. The safety features of some parts may not always be obvious. The manufacturer is not responsible for the use of other replacement parts.

 **CAUTION—POTENTIAL INJURY:** Do not cut, twist, bind, crush, or place heavy objects on the power cord. Do not subject the power cord to abrasion or stress. Do not pinch the power cord between objects such as furniture and walls. If any of these things happen, a risk of fire or electrical shock results. Inspect the power cord regularly for signs of such problems. Remove the power cord from the electrical outlet before inspecting it.

Refer service or repairs, other than those described in the user documentation, to a service representative.

 **CAUTION—SHOCK HAZARD:** To avoid the risk of electrical shock when cleaning the exterior of the printer, unplug the power cord from the electrical outlet and disconnect all cables from the printer before proceeding.

 **CAUTION—SHOCK HAZARD:** Do not use the fax feature during a lightning storm. Do not set up this product or make any electrical or cabling connections, such as the fax feature, power cord, or telephone, during a lightning storm.

 **CAUTION—TIPPING HAZARD:** Floor-mounted configurations require additional furniture for stability. You must use either a printer stand or printer base if you are using multiple input options. If you purchased a multifunction printer (MFP) that scans, copies, and faxes, then you may need additional furniture. For more information, see [www.lexmark.com/multifunctionprinters](http://www.lexmark.com/multifunctionprinters).

 **CAUTION—POTENTIAL INJURY:** To reduce the risk of equipment instability, load each tray separately. Keep all other trays closed until needed.

**SAVE THESE INSTRUCTIONS.**



# Learning about the printer

## Finding information about the printer

What are you looking for?	Find it here
Initial setup instructions: <ul style="list-style-type: none"> <li>• Connecting the printer</li> <li>• Installing the printer software</li> </ul>	Setup documentation—The setup documentation came with the printer and is also available at <a href="http://support.lexmark.com">http://support.lexmark.com</a> .
Additional setup and instructions for using the printer: <ul style="list-style-type: none"> <li>• Selecting and storing paper and specialty media</li> <li>• Loading paper</li> <li>• Configuring printer settings</li> <li>• Viewing and printing documents and photos</li> <li>• Setting up and using the printer software</li> <li>• Configuring the printer on a network</li> <li>• Caring for and maintaining the printer</li> <li>• Troubleshooting and solving problems</li> </ul>	<i>User's Guide</i> and <i>Quick Reference Guide</i> —The guides are available at <a href="http://support.lexmark.com">http://support.lexmark.com</a> . <b>Note:</b> These guides are also available in other languages.
Information on setting up and configuring the accessibility features of your printer	<i>Lexmark Accessibility Guide</i> —This guide is available at <a href="http://support.lexmark.com">http://support.lexmark.com</a> .
Help using the printer software	Windows or Mac Help—Open a printer software program or application, and then click <b>Help</b> .  Click  to view context-sensitive information. <b>Notes:</b> <ul style="list-style-type: none"> <li>• Help is automatically installed with the printer software.</li> <li>• The printer software is located in the printer program folder or on the desktop, depending on your operating system.</li> </ul>

What are you looking for?	Find it here
<p>The latest supplemental information, updates, and customer support:</p> <ul style="list-style-type: none"> <li>• Documentation</li> <li>• Driver downloads</li> <li>• Live chat support</li> <li>• E-mail support</li> <li>• Voice support</li> </ul>	<p>Lexmark support Web site—  <a href="http://support.lexmark.com">http://support.lexmark.com</a></p> <p><b>Note:</b> Select your country or region, and then select your product to view the appropriate support site.</p> <p>Support telephone numbers and hours of operation for your country or region can be found on the support Web site or on the printed warranty that came with your printer.</p> <p>Record the following information (located on the store receipt and at the back of the printer), and have it ready when you contact customer support so that they may serve you faster:</p> <ul style="list-style-type: none"> <li>• Machine Type number</li> <li>• Serial number</li> <li>• Date purchased</li> <li>• Store where purchased</li> </ul>
<p>Warranty information</p>	<p>Warranty information varies by country or region:</p> <ul style="list-style-type: none"> <li>• <b>In the U.S.</b>—See the Statement of Limited Warranty included with this printer, or go to <a href="http://support.lexmark.com">http://support.lexmark.com</a>.</li> <li>• <b>In other countries and regions</b>—See the printed warranty that came with this printer.</li> </ul>

## Selecting a location for the printer



**CAUTION—POTENTIAL INJURY:** The printer weight is greater than 18 kg (40 lb) and requires two or more trained personnel to lift it safely.

When selecting a location for the printer, leave enough room to open trays, covers, and doors. If you plan to install any options, then leave enough room for them also. It is important to:

- Set up the printer near a properly grounded and easily accessible electrical outlet.
- Make sure airflow in the room meets the latest revision of the ASHRAE 62 standard or the CEN Technical Committee 156 standard.
- Provide a flat, sturdy, and stable surface.
- Keep the printer:
  - Clean, dry, and free of dust.
  - Away from stray staples and paper clips.
  - Away from the direct airflow of air conditioners, heaters, or ventilators.
  - Free from direct sunlight and humidity extremes.
- Observe the recommended temperatures and avoid fluctuations:

Ambient temperature	15.6 to 32.2°C (60 to 90°F)
Storage temperature	-40 to 43°C (-40 to 110°F)

- Allow the following recommended amount of space around the printer for proper ventilation:

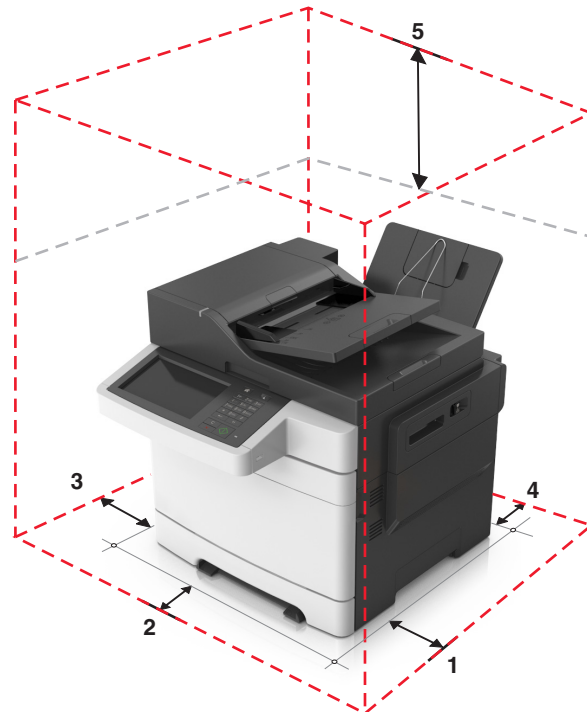

1	Right side	304.8 mm (12 in.)
2	Front	508 mm (20 in.)
3	Left side	76.2 mm (3 in.)
4	Rear	101.6 mm (4 in.)
5	Top	291.7 mm (11.5 in.)

## Printer configurations



**CAUTION—TIPPING HAZARD:** Floor-mounted configurations require additional furniture for stability. You must use either a printer stand or printer base if you are using multiple input options. If you purchased a multifunction printer (MFP) that scans, copies, and faxes, then you may need additional furniture. For more information, see [www.lexmark.com/multifunctionprinters](http://www.lexmark.com/multifunctionprinters).

## Basic models

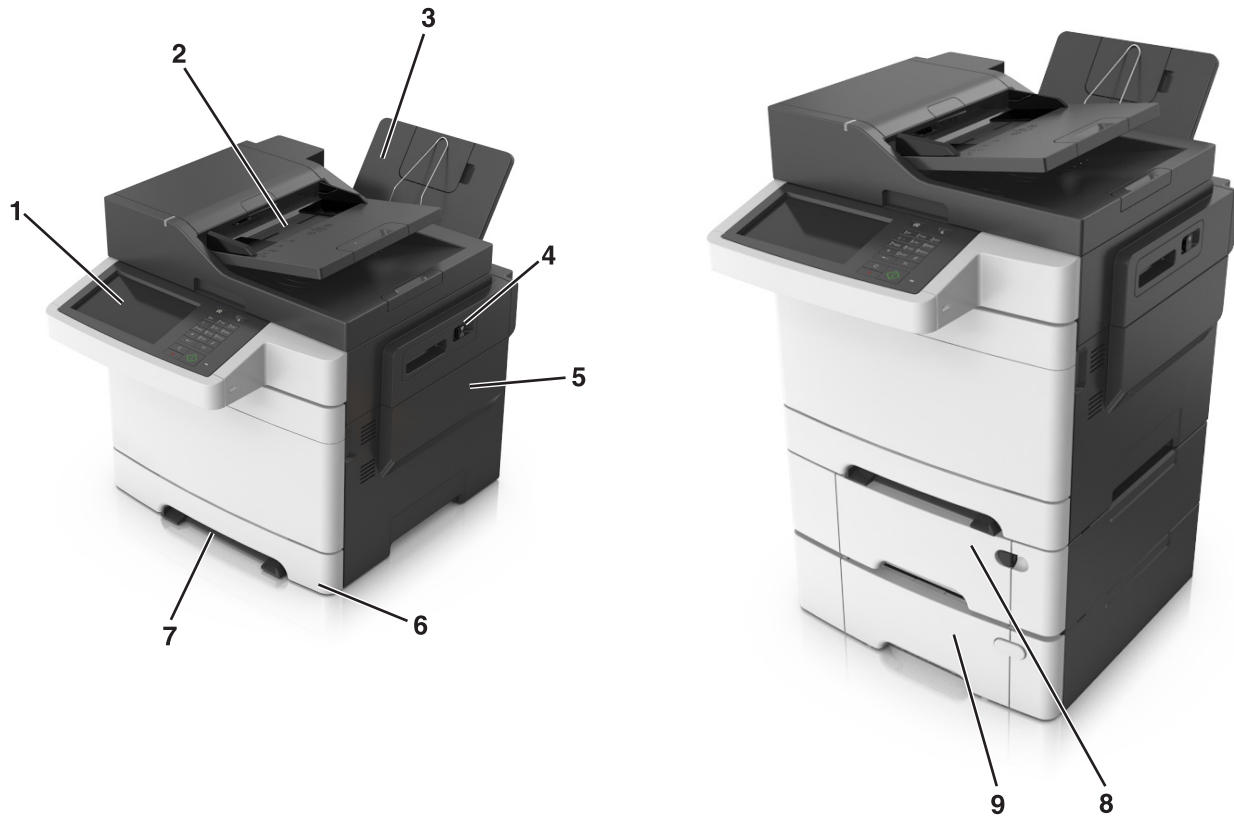



1	Printer control panel
2	Automatic document feeder (ADF)
3	Standard bin
4	Top door latch
5	Right side cover
6	Standard 250-sheet tray (Tray 1)
7	Manual feeder
8	Optional 650-sheet duo tray with integrated multipurpose feeder (Tray 2)
9	Optional 550-sheet tray (Tray 3)

## Understanding the basic functions of the scanner

- Make quick copies or set the printer to perform specific copy jobs.
- Send a fax using the printer control panel.
- Send a fax to multiple fax destinations at the same time.
- Scan documents and send them to your computer, an e-mail address, or an FTP destination.
- Scan documents and send them to another printer (PDF through an FTP).

## Using the ADF and scanner glass

Automatic document feeder (ADF)	Scanner glass
 <p>Use the ADF for multiple-page documents including two-sided (duplex) pages.</p>	 <p>Use the scanner glass for single-page documents, book pages, small items (such as postcards or photos), transparencies, photo paper, or thin media (such as magazine clippings).</p>

### Using the ADF

When using the ADF:

- Load the document into the ADF tray faceup, short edge first.
- Load up to 50 sheets of plain paper into the ADF tray.
- Scan sizes from 105 x 148 mm (4.1 x 5.8 inches) wide to 216 x 355 mm (8.5 x 14 inches) long.
- Scan media weights from 52 to 120 g/m<sup>2</sup> (14 to 32 lb).
- Do not load postcards, photos, small items, transparencies, photo paper, or thin media (such as magazine clippings) into the ADF tray. Place these items on the scanner glass.

### Using the scanner glass

When using the scanner glass:

- Place a document facedown on the scanner glass in the corner with the green arrow.
- Scan or copy documents from 216 x 296.9 mm (8.5 x 11.69 inches) dimension.
- Copy books up to 12.7 mm (0.5 inch) thick.

## Understanding the printer control panel

### Using the printer control panel

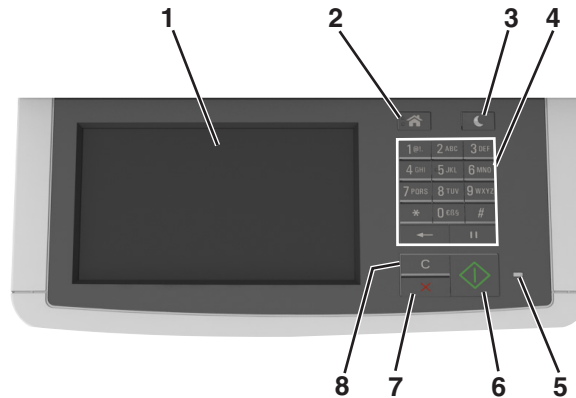

	Use the	To
1	Display	<ul style="list-style-type: none"> <li>View printing, copying, e-mailing, faxing, and scanning options.</li> <li>View printer status and error messages.</li> </ul>
2	Home button	Go to the home screen.
3	Sleep button	Enable Sleep mode or Hibernate mode.
4	Keypad	Enter numbers, letters, or symbols.
5	Indicator light	Check the status of the printer.
6	Start button	Start a job, depending on which mode is selected.
7	Stop or cancel button	Cancel all printer activity.
8	Clear all / Reset button	Reset the default settings of a function, such as printing, copying, or e-mailing.

### Understanding the home screen

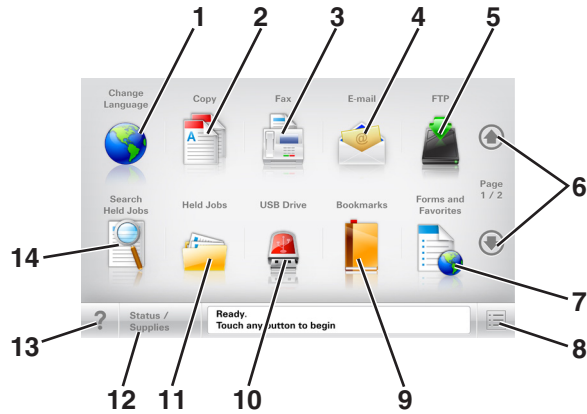

When the printer is turned on, the display shows a basic screen, referred to as the home screen. Touch the home screen buttons and icons to initiate an action such as copying, faxing, or scanning; to open the menu screen; or to respond to messages.

**Note:** Your home screen may vary depending on your home screen customization settings, administrative setup, and active embedded solutions.



Touch	To
1	Change Language Launch the Change Language pop-up window that lets you change the primary language of the printer.
2	Copy Access the Copy menus and make copies.
3	Fax Access the Fax menus and send fax.
4	E-mail Access the E-mail menus and send e-mails.
5	FTP Access the File Transfer Protocol (FTP) menus and scan documents directly to an FTP server.
6	Arrows Scroll up or down.
7	Forms and Favorites Quickly find and print frequently used online forms.
8	Menu icon Access the printer menus. <b>Note:</b> The menus are available only when the printer is in Ready state.
9	Bookmarks Create, organize, and save a set of bookmarks (URL) into a tree view of folders and file links. <b>Note:</b> The tree view supports only bookmarks created from this function, and not from any other application.
10	USB Drive View, select, print, scan, or e-mail photos and documents from a flash drive. <b>Note:</b> This icon appears only when you return to the home screen while a memory card or flash drive is connected to the printer.
11	Held Jobs Display all current held jobs.
12	Status/Supplies <ul style="list-style-type: none"> <li>Show a warning or error message whenever the printer requires intervention to continue processing.</li> <li>Access the messages screen for more information on the message, and how to clear it.</li> </ul>
13	Tips Open a context-sensitive Help dialog.
14	Search Held Jobs Search for one or more of the following items: <ul style="list-style-type: none"> <li>User name for held or confidential print jobs</li> <li>Job names for held jobs, excluding confidential print jobs</li> <li>Profile names</li> <li>Bookmark container or print job names</li> <li>USB container or print job names for supported file types</li> </ul>

## Features

Feature	Description
Menu trail line Example: <u>Menus</u> > <u>Settings</u> > <u>Copy Settings</u> > Number of Copies	A menu trail line is located at the top of each menu screen. This feature shows the path taken to arrive at the current menu.  Touch any of the underlined words to return to that menu.  Number of Copies is not underlined because it is the current screen. If you touch an underlined word on the “Number of Copies” screen before the number of copies is set and saved, then the selection is not saved, and it does not become the default setting.
Attendance message alert  	If an attendance message affects a function, then this icon appears and the red indicator light blinks.
Warning  	If an error condition occurs, then this icon appears.
Status message bar	<ul style="list-style-type: none"> <li>• Show the current printer status such as <b>Ready</b> or <b>Busy</b>.</li> <li>• Show printer conditions such as <b>Toner Low</b> or <b>Cartridge Low</b>.</li> <li>• Show intervention messages so the printer can continue processing.</li> </ul>
Printer IP address Example: 123 . 123 . 123 . 123	The IP address of your network printer is located at the upper left corner of the home screen and appears as four sets of numbers separated by periods. You can use the IP address when accessing the Embedded Web Server so you can view and remotely configure printer settings even when you are not physically near the printer.

## Understanding the colors of the Sleep button and indicator lights

The colors of the Sleep button and indicator lights on the printer control panel signify a certain printer status or condition.

Indicator light	Printer status
Off	The printer is off or in Hibernate mode.
Blinking green	The printer is warming up, processing data, or printing.
Solid green	The printer is on, but idle.
Blinking red	The printer requires user intervention.

Sleep button light	Printer status
Off	The printer is off, idle or in Ready state.
Solid amber	The printer is in Sleep mode.
Blinking amber	The printer is entering or waking from Hibernate mode.



Sleep button light	Printer status
Blinking amber for 0.1 second, then goes completely off for 1.9 seconds in a slow, pulsing pattern	The printer is in Hibernate mode.

## Using the touch-screen buttons

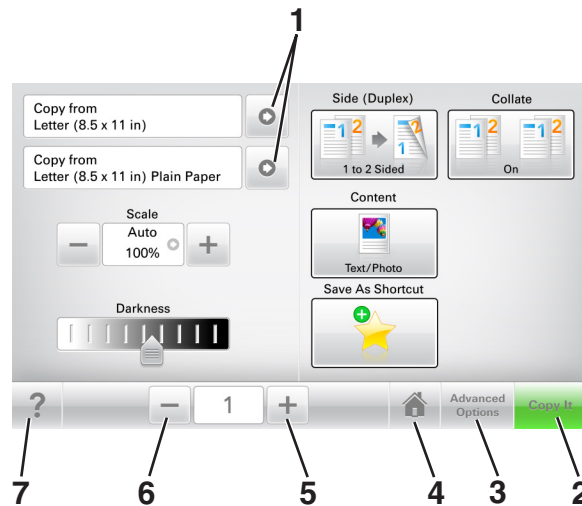

**Note:** Your home screen, icons, and buttons may vary, depending on your home screen customization settings, administrative setup, and active embedded solutions.



	Touch	To
1	Arrows	View a list of options.
2	Copy It	Print a copy.
3	Advanced Options	Select a copy option.
4	Home	Go to the home screen.
5	Increase	Select a higher value.
6	Decrease	Select a lower value.
7	Tips	Open a context-sensitive Help dialog.

## Other touch-screen buttons

Touch	To
Accept 	Save a setting.

Touch	To
<p data-bbox="149 275 224 302">Cancel</p> 	<ul data-bbox="594 279 1393 348" style="list-style-type: none"><li>• Cancel an action or a selection.</li><li>• Exit a screen and return to the previous screen without saving changes.</li></ul>
<p data-bbox="149 447 212 474">Reset</p> 	<p data-bbox="581 447 873 474">Reset values on the screen.</p>

# Setting up and using the home screen applications

## Notes:

- Your home screen may vary depending on your home screen customization settings, administrative setup, and active embedded applications. Some applications are supported only in some printer models.
- There may be additional solutions and applications available for purchase. For more information, go to [www.lexmark.com](http://www.lexmark.com) or contact the place where you purchased the printer.

## Finding the IP address of the computer

### For Windows users

- 1 In the Run dialog box, type `cmd` to open the command prompt.
- 2 Type `ipconfig`, and then look for the IP address.

### For Macintosh users

- 1 From System Preferences in the Apple menu, select **Network**.
- 2 Select your connection type, and then click **Advanced > TCP/IP**.
- 3 Look for the IP address.

## Finding the IP address of the printer

**Note:** Make sure your printer is connected to a network or to a print server.

You can find the printer IP address:

- From the top left corner of the printer home screen.
- From the TCP/IP section in the Network/Ports menu.
- By printing a network setup page or menu settings page, and then finding the TCP/IP section.

**Note:** An IP address appears as four sets of numbers separated by periods, such as 123.123.123.123.

## Accessing the Embedded Web Server

The Embedded Web Server is the printer Web page that lets you view and remotely configure printer settings even when you are not physically near the printer.

- 1 Obtain the printer IP address:
  - From the printer control panel home screen
  - From the TCP/IP section in the Network/Ports menu
  - By printing a network setup page or menu settings page, and then finding the TCP/IP section

**Note:** An IP address appears as four sets of numbers separated by periods, such as 123 . 123 . 123 . 123 .

- 2 Open a Web browser, and then type the printer IP address in the address field.

### 3 Press **Enter**.

**Note:** If you are using a proxy server, then temporarily disable it to load the Web page correctly.

## Customizing the home screen

### 1 Open a Web browser, and then type the printer IP address in the address field.

**Note:** View the printer IP address on the printer home screen. The IP address appears as four sets of numbers separated by periods, such as 123.123.123.123.

### 2 Do one or more of the following:

- Show or hide the icons of basic printer functions.
  - a Click **Settings > General Settings > Home screen customization**.
  - b Select the check boxes to specify which icons appear on the home screen.

**Note:** If you clear a check box beside an icon, then the icon does not appear on the home screen.

- c Click **Submit**.
- Customize the icon for an application. For more information, see [“Finding information about the home screen applications” on page 21](#) or see the documentation that came with the application.

## Understanding the different applications

Use	To
<b>Card Copy</b>	Scan and print both sides of a card on a single page. For more information, see <a href="#">“Setting up Card Copy” on page 22</a> .
<b>Fax</b>	Scan a document, and then send it to a fax number. For more information, see <a href="#">“Faxing” on page 89</a> .
<b>Forms and Favorites</b>	Quickly find and print frequently used online forms directly from the printer home screen. For more information, see <a href="#">“Setting up Forms and Favorites” on page 21</a> .
<b>Multi Send</b>	Scan a document, and then send it to multiple destinations. For more information, see <a href="#">“Setting up Multi Send” on page 23</a> .
<b>MyShortcut</b>	Create shortcuts directly on the printer home screen. For more information, see <a href="#">“Using MyShortcut” on page 22</a> .
<b>Scan to E-mail</b>	Scan a document, and then send it to an e-mail address. For more information, see <a href="#">“E-mailing” on page 82</a> .
<b>Scan to Computer</b>	Scan a document, and then save it to a predefined folder on a host computer. For more information, see <a href="#">“Setting up Scan to Computer” on page 116</a> .
<b>Scan to FTP</b>	Scan documents directly to a File Transfer Protocol (FTP) server. For more information, see <a href="#">“Scanning to an FTP address” on page 112</a> .
<b>Scan to Network</b>	Scan a document, and then send it to a network shared folder. For more information, see <a href="#">“Setting up Scan to Network” on page 23</a> .

## Activating the home screen applications

### Finding information about the home screen applications

Your printer comes with preinstalled home screen applications. Before you can use these applications, you must first activate and set up these applications using the Embedded Web Server. For more information on accessing the Embedded Web Server, see [“Accessing the Embedded Web Server” on page 19](#).

For more information on configuring and using the home screen applications, do the following:

- 1 Go to <http://support.lexmark.com>.
- 2 Click **Software Solutions**, and then select either of the following:
  - **Scan to Network**—This lets you find information about the Scan to Network application.
  - **Other Applications**—This lets you find information about the other applications.
- 3 Click the **Manuals** tab, and then select the document for the home screen application.

### Setting up Forms and Favorites

**Note:** A later version of this *User's Guide* may contain a direct link to the *Administrator's Guide* of this application. To check for updates of this *User's Guide*, go to <http://support.lexmark.com>.

Use	To
	<p>Streamline work processes by letting you quickly find and print frequently used online forms directly from the printer home screen.</p> <p><b>Note:</b> The printer must have permission to access the network folder, FTP site, or Web site where the bookmark is stored. From the computer where the bookmark is stored, use sharing, security, and firewall settings to allow the printer at least a <i>read</i> access. For help, see the documentation that came with your operating system.</p>

- 1 Open a Web browser, and then type the printer IP address in the address field.

**Note:** View the printer IP address on the printer home screen. The IP address appears as four sets of numbers separated by periods, such as 123.123.123.123.

- 2 Click **Settings > Apps > Apps Management > Forms and Favorites**.
- 3 Click **Add**, and then customize the settings.

**Notes:**

- See the mouse-over help beside each field for a description of the setting.
- To make sure the location settings of the bookmark are correct, type the correct IP address of the host computer where the bookmark is located. For more information on obtaining the IP address of the host computer, see [“Finding the IP address of the computer” on page 19](#).
- Make sure the printer has access rights to the folder where the bookmark is located.

- 4 Click **Apply**.

To use the application, touch **Forms and Favorites** on the printer home screen, and then navigate through form categories, or search for forms based on a form number, name, or description.

## Setting up Card Copy

**Note:** A later version of this *User's Guide* may contain a direct link to the *Administrator's Guide* of this application. To check for updates of this *User's Guide*, go to <http://support.lexmark.com>.

Use	To
	<p>Quickly and easily copy insurance, identification, and other wallet-size cards.</p> <p>You can scan and print both sides of a card on a single page, saving paper and showing the information on the card in a more convenient manner.</p>

**1** Open a Web browser, and then type the printer IP address in the address field.

**Note:** View the printer IP address on the printer home screen. The IP address appears as four sets of numbers separated by periods, such as 123.123.123.123.

**2** Click **Settings > Apps > Apps Management > Card Copy**.

**3** Change the default scanning options, if necessary.

- **Default tray**—Select the default tray to be used for printing scan images.
- **Default number of copies**—Specify the number of copies that should automatically print when the application is used.
- **Default contrast setting**—Specify a setting to increase or decrease the level of contrast when a copy of the scanned card is printed. Select **Best for Content** if you want the printer to adjust the contrast automatically.
- **Default scale setting**—Set the size of the scanned card when printed. The default setting is 100% (full size).
- **Color Output**—Select the check box to print the scanned card in color, or clear it to scan in black and white.
- **Resolution setting**—Adjust the quality of the scanned card.

**Notes:**

- When scanning a card, make sure the scan resolution is not more than 200 dpi for color, and 400 dpi for black and white.
- When scanning multiple cards, make sure the scan resolution is not more than 150 dpi for color, and 300 dpi for black and white.

- **Print Borders**—Select the check box to print the scan image with a border around it.

**4** Click **Apply**.

To use the application, touch **Card Copy** on the printer home screen, and then follow the instructions.

## Using MyShortcut

**Note:** A later version of this *User's Guide* may contain a direct link to the *Administrator's Guide* of this application. To check for updates of this *User's Guide*, go to <http://support.lexmark.com>.

Use	To
	Create shortcuts on the printer home screen, with settings for up to 25 frequently used copy, fax, or e-mail jobs.

To use the application, touch **MyShortcut**, and then follow the instructions on the printer display.

## Setting up Multi Send

**Note:** A later version of this *User's Guide* may contain a direct link to the *Administrator's Guide* of this application. To check for updates of this *User's Guide*, go to <http://support.lexmark.com>.

Use	To
	Scan a document, and then send the scanned document to multiple destinations. <b>Note:</b> Make sure there is enough space in the printer hard disk.

- 1 Open a Web browser, and then type the printer IP address in the address field.

**Note:** View the printer IP address on the printer home screen. The printer IP address appears as four sets of numbers separated by periods, such as 123.123.123.123.

- 2 Click **Settings** > **Apps** > **Apps Management** > **Multi Send**.

- 3 From the Profiles section, click **Add**, and then customize the settings.

**Notes:**

- See the mouse-over help beside each field for a description of the setting.
- If you select **FTP** or **Share Folder** as a destination, then make sure the location settings of the destination are correct. Type the correct IP address of the host computer where the specified destination is located. For more information on obtaining the IP address of the host computer, see [“Finding the IP address of the computer” on page 19](#).

- 4 Click **Apply**.

To use the application, touch **Multi Send** on the printer home screen, and then follow the instructions on the printer display.

## Setting up Scan to Network

**Note:** A later version of this *User's Guide* may contain a direct link to the *Administrator's Guide* of this application. To check for updates of this *User's Guide*, go to <http://support.lexmark.com>.

Use	To
	<p>Scan a document and send it to a shared network folder. You can define up to 30 unique folder destinations.</p> <p><b>Notes:</b></p> <ul style="list-style-type: none"> <li>• The printer must have permission to write to the destinations. From the computer where the destination is specified, use sharing, security, and firewall settings to allow the printer at least a <i>write</i> access. For help, see the documentation that came with your operating system.</li> <li>• The Scan to Network icon appears only when one or more destinations are defined.</li> </ul>

- 1 Open a Web browser, and then type the printer IP address in the address field.

**Note:** View the printer IP address on the printer home screen. The IP address appears as four sets of numbers separated by periods, such as 123.123.123.123.

- 2 Do either of the following:
  - Click **Set up Scan to Network** > **Click here**.
  - Click **Settings** > **Apps** > **Apps Management** > **Scan to Network**.

- 3 Specify the destinations, and then customize the settings.

**Notes:**

- See the mouse-over help beside some of the fields for a description of the setting.
- To make sure the location settings of the destination are correct, type the correct IP address of the host computer where the specified destination is located. For more information on obtaining the IP address of the host computer, see [“Finding the IP address of the computer” on page 19](#).
- Make sure the printer has access rights to the folder where the specified destination is located.

- 4 Click **Apply**.

To use the application, touch **Scan to Network** on the printer home screen, and then follow the instructions on the printer display.

## Setting up Remote Operator Panel

This application enables you to interact with the printer control panel even when you are not physically near the network printer. From your computer, you can view the printer status, release held print jobs, create bookmarks, and do other print-related tasks.

- 1 Open a Web browser, and then type the printer IP address in the address field.

**Note:** View the printer IP address on the printer home screen. The IP address appears as four sets of numbers separated by periods, such as 123.123.123.123.

- 2 Click **Settings** > **Remote Operator Panel Settings**.
- 3 Select the **Enable** check box, and then customize the settings.
- 4 Click **Submit**.

To use the application, click **Remote Operator Panel** > **Launch VNC Applet**.



## Exporting and importing a configuration

You can export configuration settings into a text file, and then import the file to apply the settings to other printers.

- 1 Open a Web browser, and then type the printer IP address in the address field.

**Note:** View the printer IP address on the printer home screen. The IP address appears as four sets of numbers separated by periods, such as 123.123.123.123.

- 2 To export or import a configuration for one application, do the following:

- a Click **Settings > Apps > Apps Management**.

- b From the list of installed applications, click the name of the application you want to configure.

- c Click **Configure**, and then do either of the following:

- To export a configuration to a file, click **Export**, and then follow the instructions on the computer screen to save the configuration file.

**Notes:**

- When saving the configuration file, you can type a unique file name or use the default name.
- If a "JVM Out of Memory" error occurs, then repeat the export process until the configuration file is saved.

- To import a configuration from a file, click **Import**, and then browse to the saved configuration file that was exported from a previously configured printer.

**Notes:**

- Before importing the configuration file, you can choose to preview it first or load it directly.
- If a timeout occurs and a blank screen appears, then refresh the Web browser, and then click **Apply**.

- 3 To export or import a configuration for multiple applications, do the following:

- a Click **Settings > Import/Export**.

- b Do either of the following:

- To export a configuration file, click **Export Embedded Solutions Settings File**, and then follow the instructions on the computer screen to save the configuration file.

- To import a configuration file, do the following:

- 1 Click **Import Embedded Solutions Settings File > Choose File**, and then browse to the saved configuration file that was exported from a previously configured printer.

- 2 Click **Submit**.

# Additional printer setup

## Installing internal options

 **CAUTION—SHOCK HAZARD:** If you are accessing the controller board or installing optional hardware or memory devices sometime after setting up the printer, then turn the printer off, and unplug the power cord from the electrical outlet before continuing. If you have any other devices attached to the printer, then turn them off as well, and unplug any cables going into the printer.

**Warning—Potential Damage:** Controller board electronic components are easily damaged by static electricity. Touch a metal surface on the printer before touching any controller board electronic components or connectors.

## Available internal options

- Memory card
  - DDR3 DIMM
- Flash memory
  - Fonts
  - Firmware
    - Forms and Barcode
    - Prescribe
    - IPDS
- Printer hard disk

**Note:** To install a printer hard disk, contact customer support at <http://support.lexmark.com> or your service representative.

## Accessing the controller board

 **CAUTION—SHOCK HAZARD:** If you are accessing the controller board or installing optional hardware or memory devices sometime after setting up the printer, then turn the printer off, and unplug the power cord from the electrical outlet before continuing. If you have any other devices attached to the printer, then turn them off as well, and unplug any cables going into the printer.

**Note:** This task requires a flat-head screwdriver.

- 1 At the back of the printer, turn the screws counterclockwise to remove them.

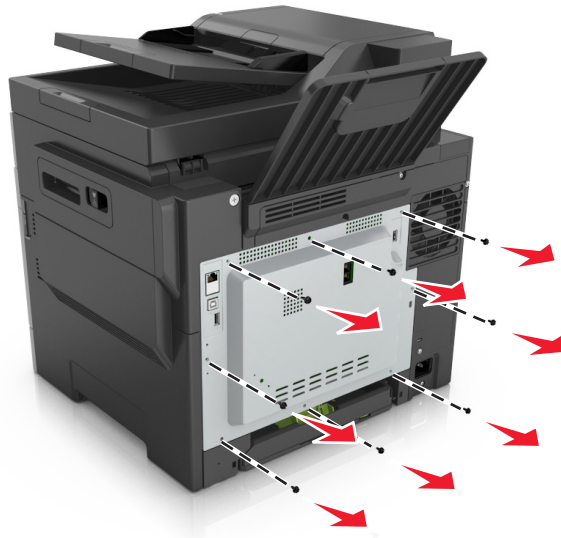

- 2 Slightly open the controller board access cover, and then shift to the right to remove it.

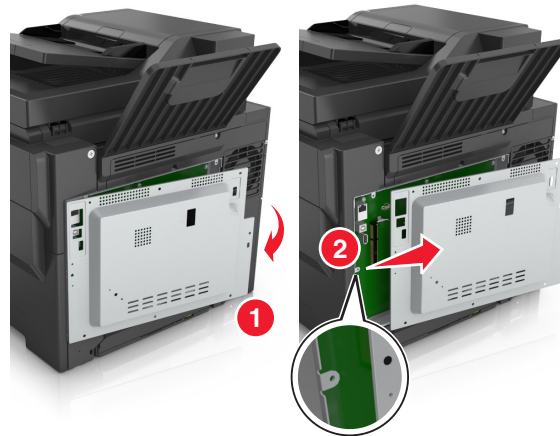

- 3 Locate the appropriate connector on the controller board.

**Warning—Potential Damage:** Controller board electronic components are easily damaged by static electricity. Touch a metal surface on the printer before touching any controller board electronic components or connectors.

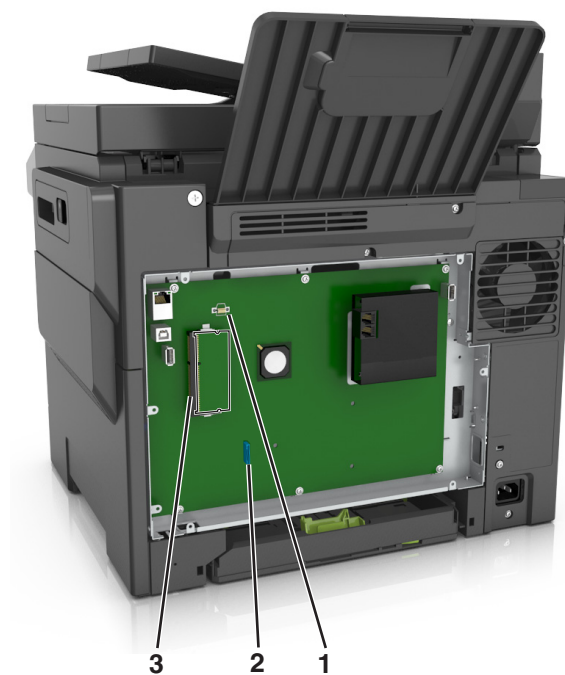

1	Flash memory or font card connector
2	Printer hard disk connector
3	Memory card connector

4 Reattach the cover.

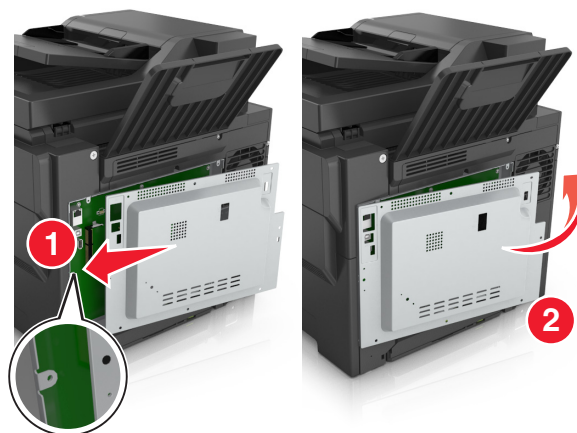

- 5 Turn the screws clockwise to lock the cover.

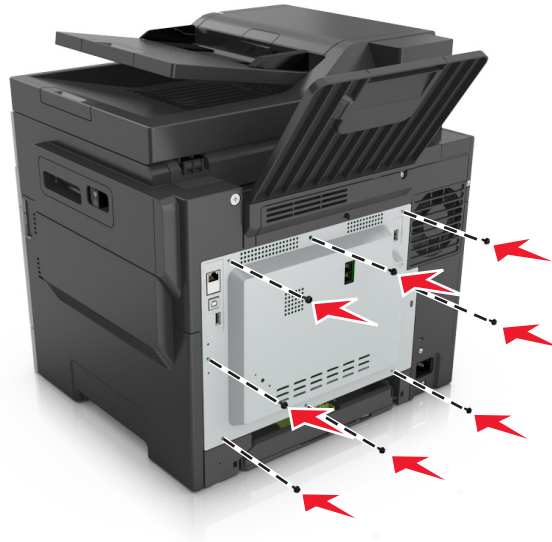

## Installing a memory card

**⚠ CAUTION—SHOCK HAZARD:** If you are accessing the controller board or installing optional hardware or memory devices sometime after setting up the printer, then turn the printer off, and unplug the power cord from the electrical outlet before continuing. If you have any other devices attached to the printer, then turn them off as well, and unplug any cables going into the printer.

- 1 Access the controller board.

For more information, see [“Accessing the controller board” on page 26](#).

- 2 Unpack the memory card.

**Warning—Potential Damage:** Do not touch the connection points along the edge of the card. Doing so may cause damage.

- 3 Align the notch (1) on the memory card with the ridge (2) on the connector.

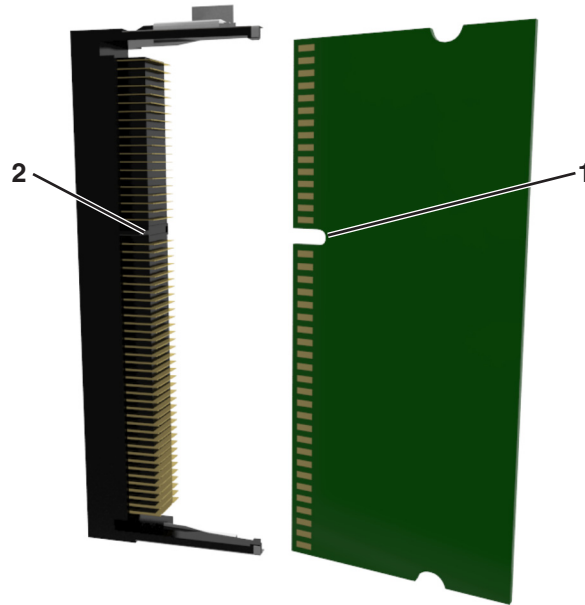

- 4 Push the memory card straight into the connector, and then push the card toward the controller board wall until it *clicks* into place.

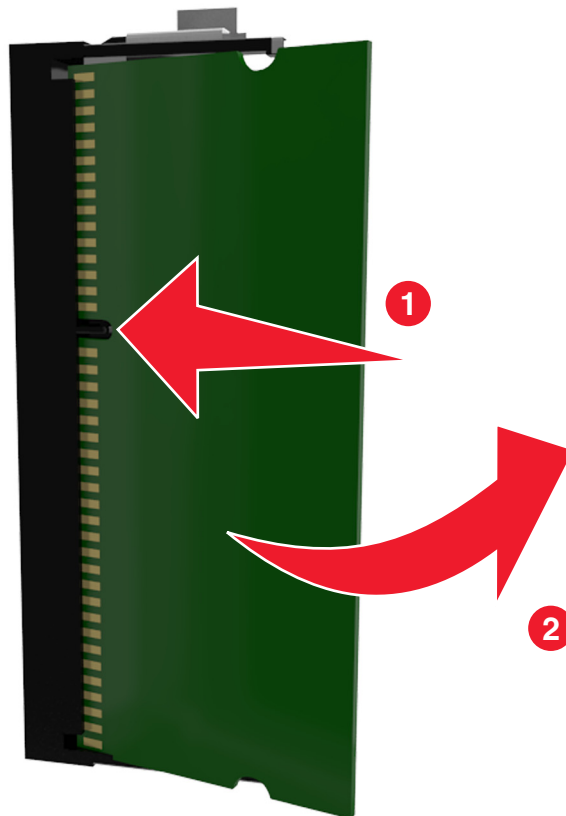

- 5 Close the controller board access cover.

## Installing an optional card

**⚠ CAUTION—SHOCK HAZARD:** If you are accessing the controller board or installing optional hardware or memory devices sometime after setting up the printer, then turn the printer off, and unplug the power cord from the electrical outlet before continuing. If you have other devices attached to the printer, then turn them off as well, and unplug any cables going into the printer.

**Warning—Potential Damage:** Controller board electronic components are easily damaged by static electricity. Touch a metal surface on the printer before touching any controller board electronic components or connectors.

**1** Access the controller board.

For more information, see [“Accessing the controller board” on page 26](#).

**2** Unpack the optional card.

**Warning—Potential Damage:** Avoid touching the connection points along the edge of the card.

**3** Holding the card by its sides, align the plastic pins (1) on the card with the holes (2) on the controller board.

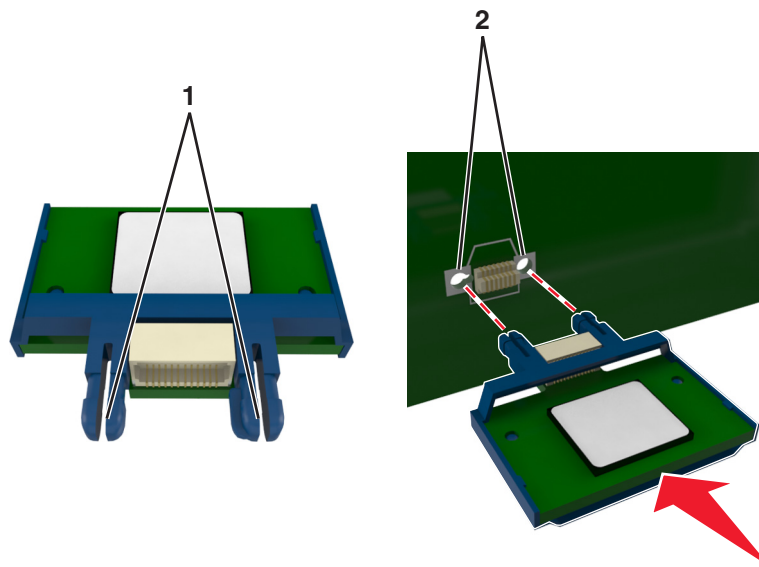

- 4 Push the card firmly into place as shown in the illustration.

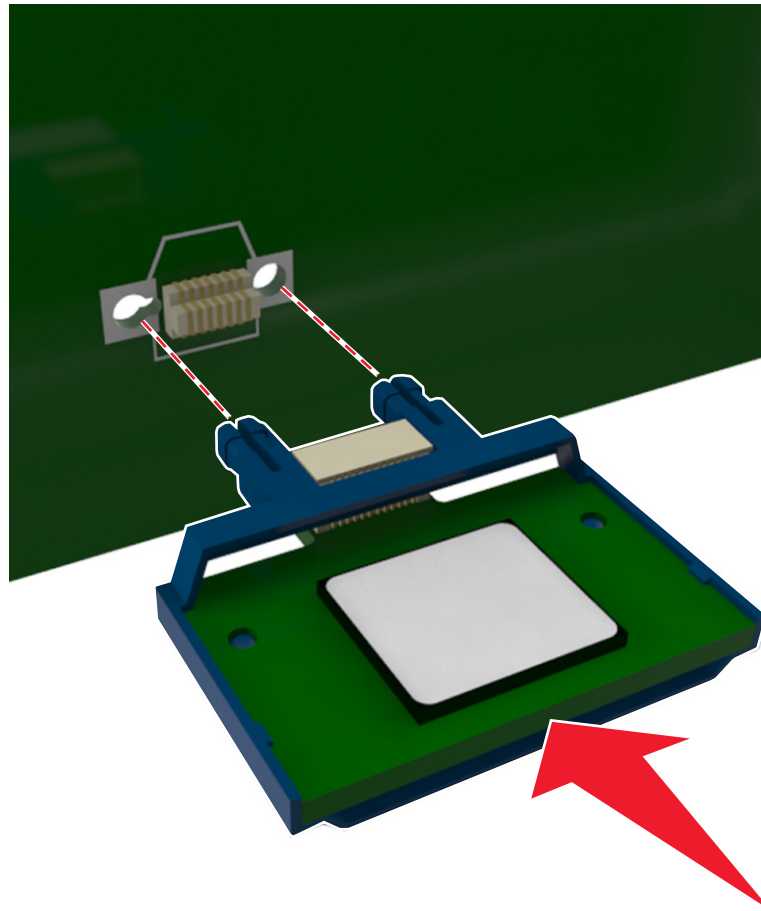

**Warning—Potential Damage:** Improper installation of the card may cause damage to the card and the controller board.

**Note:** The entire length of the connector on the card must touch and be flushed against the controller board.

- 5 Close the controller board access door.

**Note:** When the printer software and any hardware options are installed, it may be necessary to manually add the options in the printer driver to make them available for print jobs. For more information, see [“Adding available options in the print driver” on page 37](#).

## Installing hardware options

### Order of installation

**CAUTION—POTENTIAL INJURY:** The printer weight is greater than 18 kg (40 lb) and requires two or more trained personnel to lift it safely.



**CAUTION—SHOCK HAZARD:** If you are accessing the controller board or installing optional hardware or memory devices sometime after setting up the printer, then turn the printer off, and unplug the power cord from the electrical outlet before continuing. If you have any other devices attached to the printer, then turn them off as well, and unplug any cables going into the printer.

Install the printer and any optional tray in the following order:

- Optional 550-sheet tray (Tray 3)
- Optional 650-sheet duo tray with integrated multipurpose feeder (Tray 2)
- Printer

## Installing optional trays

The printer supports two optional input sources: a 550-sheet tray (Tray 3) and a 650-sheet duo tray (Tray 2) with an integrated multipurpose feeder.

**CAUTION—POTENTIAL INJURY:** The printer weight is greater than 18 kg (40 lb) and requires two or more trained personnel to lift it safely.

**CAUTION—SHOCK HAZARD:** If you are accessing the controller board or installing optional hardware or memory devices sometime after setting up the printer, then turn the printer off, and unplug the power cord from the electrical outlet before continuing. If you have any other devices attached to the printer, then turn them off as well, and unplug any cables going into the printer.

- 1 Unpack the optional tray and the dust cover, and then remove all packing material.

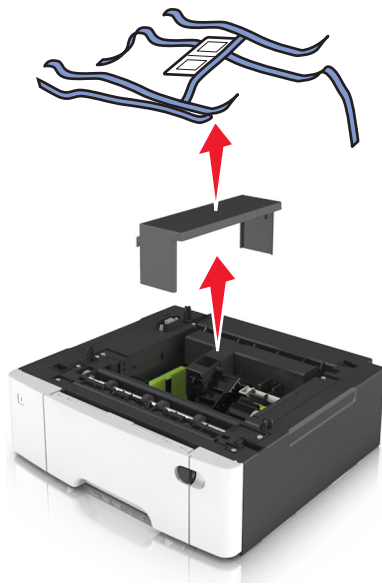

- 2 Place the tray near the printer.
- 3 Align the 650-sheet duo tray with the 550-sheet tray, and then lower it into place.

### Notes:

- If you are installing both the optional trays, then the 550-sheet tray (Tray 3) must always be below the 650-sheet tray (Tray 2).
- The standard 250-sheet tray can be labeled as Tray 1 by using the tray number label that came with the optional tray.

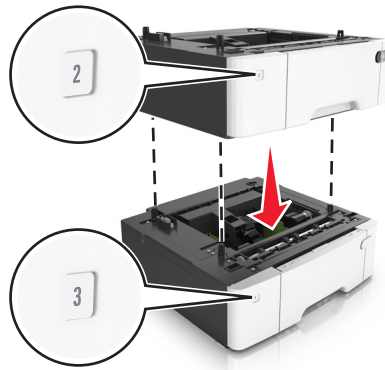

**4** Align the printer with the 650-sheet duo tray, and then lower the printer into place.



## 5 Install the dust covers.

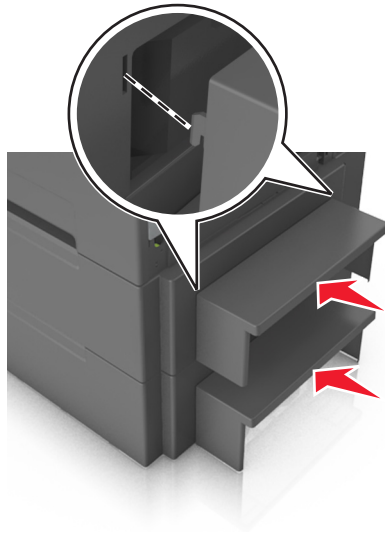

**Note:** When the printer software and any hardware options are installed, you may need to manually add the options in the printer driver to make them available for print jobs. For more information, see [“Adding available options in the print driver” on page 37.](#)

## Attaching cables

**⚠ CAUTION—POTENTIAL INJURY:** Do not use the fax feature during a lightning storm. Do not set up this product or make any electrical or cabling connections, such as the fax feature, power cord, or telephone, during a lightning storm.

Connect the printer to the computer using a USB cable or to the network using an Ethernet cable.

Make sure to match the following:

- The USB symbol on the cable with the USB symbol on the printer
- The appropriate Ethernet cable to the Ethernet port

**Warning—Potential Damage:** Do not touch the USB cable, any network adapter, or the printer in the area shown while actively printing. Loss of data or a malfunction can occur.

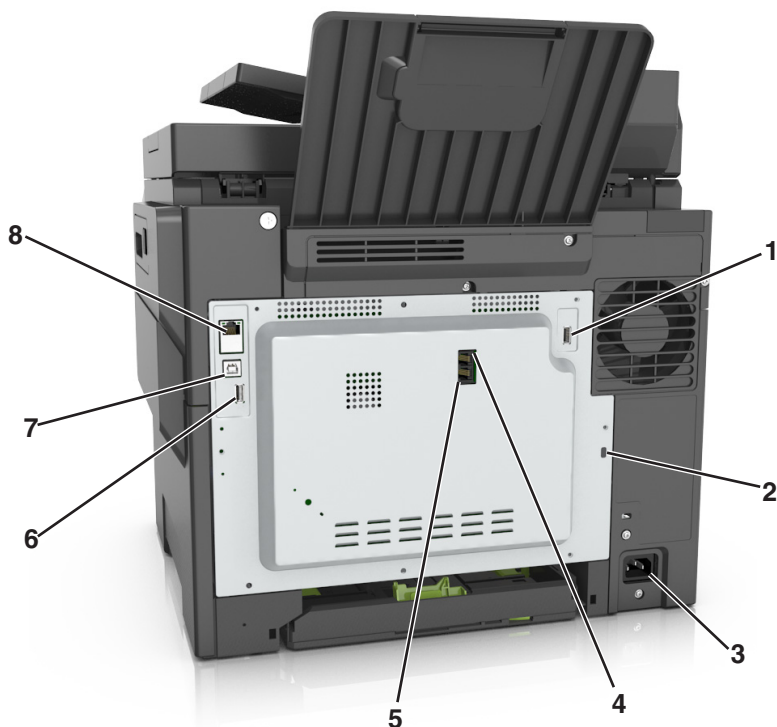

	Use the	To
1	USB wireless port	Attach an optional wireless network adapter.
2	Security lock port	Lock the controller board.
3	Printer power cord socket	Connect the printer to a properly grounded electrical outlet.
4	LINE port	Connect the printer to an active telephone line through a standard wall jack (RJ-11), DSL filter, or VoIP adapter, or any other adapter that allows you to access the telephone line to send and receive faxes.
5	EXT port	Connect additional devices (telephone or answering machine) to the printer and the telephone line. Use this port if you do not have a dedicated fax line for the printer and if this connection method is supported in your country or region. <b>Note:</b> Remove the adapter plug to access the port.
6	Rear USB port	Attach a keyboard.
7	USB printer port	Connect the printer to a computer using a USB cable.
8	Ethernet port	Connect the printer to an Ethernet network.

## Setting up the printer software

### Installing the printer

- 1 Obtain a copy of the software installer package.
- 2 Run the installer, and then follow the instructions on the computer screen.

- 3 For Macintosh users, add the printer.

**Note:** Obtain the printer IP address from the TCP/IP section in the Network/Ports menu.

## Adding available options in the print driver

### For Windows users

- 1 Open the printers folder.

#### In Windows 8

From the Search charm, type **run**, and then navigate to:

**Run > type control printers > OK**

#### In Windows 7 or earlier

- a Click , or click **Start** and then click **Run**.
  - b Type **control printers**.
  - c Press **Enter**, or click **OK**.
- 2 Select the printer you want to update, and then do either of the following:
    - For Windows 7 or later, select **Printer properties**.
    - For earlier versions, select **Properties**.
  - 3 Navigate to the Configuration tab, and then select **Update Now - Ask Printer**.
  - 4 Apply the changes.

### For Macintosh users

- 1 From System Preferences in the Apple menu, navigate to your printer, and then select **Options & Supplies**.
- 2 Navigate to the list of hardware options, and then add any installed options.
- 3 Apply the changes.

## Networking

### Notes:

- Purchase a MarkNet™ N8352 wireless network adapter before setting up the printer on a wireless network. For information on installing the wireless network adapter, see the instruction sheet that came with the adapter.
- A Service Set Identifier (SSID) is a name assigned to a wireless network. Wired Equivalent Privacy (WEP), Wi-Fi Protected Access (WPA), WPA2, and 802.1X - RADIUS are types of security used on a network.

## Preparing to set up the printer on an Ethernet network

To configure your printer to connect to an Ethernet network, organize the following information before you begin:

**Note:** If your network automatically assigns IP addresses to computers and printers, continue on to installing the printer.

- A valid, unique IP address for the printer to use on the network
- The network gateway
- The network mask
- A nickname for the printer (optional)

**Note:** A printer nickname can make it easier for you to identify your printer on the network. You can choose to use the default printer nickname, or assign a name that is easier for you to remember.

You will need an Ethernet cable to connect the printer to the network and an available port where the printer can physically connect to the network. Use a new network cable when possible to avoid potential problems caused by a damaged cable.

## Preparing to set up the printer on a wireless network

### Notes:

- Make sure your wireless network adapter is installed in your printer and working properly. For more information, see the instruction sheet that came with the wireless network adapter.
- Make sure your access point (wireless router) is turned on and is working properly.

Make sure you have the following information before setting up the printer on a wireless network:

- **SSID**—The SSID is also referred to as the network name.
- **Wireless Mode (or Network Mode)**—The mode is either infrastructure or ad hoc.
- **Channel (for ad hoc networks)**—The channel defaults to automatic for infrastructure networks.

Some ad hoc networks will also require the automatic setting. Check with your system support person if you are not sure which channel to select.

- **Security Method**—There are four basic options for Security Method:

- WEP key

If your network uses more than one WEP key, then enter up to four in the provided spaces. Select the key currently in use on the network by selecting the default WEP transmit key.

- WPA or WPA2 preshared key or passphrase

WPA includes encryption as an additional layer of security. The choices are AES or TKIP. Encryption must be set for the same type on the router and on the printer, or the printer will not be able to communicate on the network.

- 802.1X–RADIUS

If you are installing the printer on an 802.1X network, then you may need the following:

- Authentication type
- Inner authentication type
- 802.1X user name and password
- Certificates

- No security

If your wireless network does not use any type of security, then you will not have any security information.

**Note:** We do not recommend using an unsecured wireless network.

**Notes:**

- If you do not know the SSID of the network that your computer is connected to, then launch the wireless utility of the computer network adapter, and then look for the network name. If you cannot find the SSID or the security information for your network, then see the documentation that came with the access point, or contact your system support person.
- To find the WPA/WPA2 preshared key or passphrase for the wireless network, see the documentation that came with the access point, see the Embedded Web Server associated with the access point, or consult your system support person.

## Connecting the printer using the Wireless Setup Wizard

Before you begin, make sure that:

- A wireless network adapter is installed in the printer and is working properly. For more information, see the instruction sheet that came with the wireless network adapter.
- An Ethernet cable is disconnected from the printer.
- Active NIC is set to Auto. To set this to Auto, navigate to:

 > **Network/Ports** > **Active NIC** > **Auto** > **Submit**

**Note:** Make sure to turn off the printer, then wait for at least five seconds, and then turn the printer back on.

- 1 From the printer control panel, navigate to:

 > **Network/Ports** > **Network [x]** > **Network [x] Setup** > **Wireless** > **Wireless Connection Setup**

- 2 Select a wireless connection setup.

Use	To
<b>Search for networks</b>	Show available wireless connections. <b>Note:</b> This menu item shows all broadcast secured or unsecured SSIDs.
<b>Enter a network name</b>	Manually type the SSID. <b>Note:</b> Make sure to type the correct SSID.
<b>Wi-Fi Protected Setup</b>	Connect the printer to a wireless network using Wi-Fi Protected Setup.

- 3 Follow the instructions on the printer display.

## Connecting the printer to a wireless network using Wi-Fi Protected Setup

Before you begin, make sure that:

- The access point (wireless router) is Wi-Fi Protected Setup (WPS) certified or WPS-compatible. For more information, see the documentation that came with your access point.
- A wireless network adapter installed in your printer is attached and working properly. For more information, see the instruction sheet that came with the wireless network adapter.

## Using the Push Button Configuration method

- 1 From the printer control panel, navigate to:



> **Network/Ports** > **Network [x]** > **Network [x] Setup** > **Wireless** > **Wireless Connection Setup** > **Wi-Fi Protected Setup** > **Start Push Button Method**

- 2 Follow the instructions on the printer display.

## Using the Personal Identification Number (PIN) method

- 1 From the printer control panel, navigate to:



> **Network/Ports** > **Network [x]** > **Network [x] Setup** > **Wireless** > **Wireless Connection Setup** > **Wi-Fi Protected Setup** > **Start PIN Method**

- 2 Copy the eight-digit WPS PIN.
- 3 Open a Web browser, and then type the IP address of your access point in the address field.

### Notes:

- The IP address appears as four sets of numbers separated by periods, such as 123.123.123.123.
- If you are using a proxy server, then temporarily disable it to load the Web page correctly.

- 4 Access the WPS settings. For more information, see the documentation that came with your access point.
- 5 Enter the eight-digit PIN, and then save the setting.

## Connecting the printer to a wireless network using the Embedded Web Server

Before you begin, make sure that:

- Your printer is connected temporarily to an Ethernet network.
- A wireless network adapter is installed in your printer and working properly. For more information, see the instruction sheet that came with the wireless network adapter.

- 1 Open a Web browser, and then type the printer IP address in the address field.

### Notes:

- View the printer IP address on the printer control panel. The IP address appears as four sets of numbers separated by periods, such as 123.123.123.123.
- If you are using a proxy server, then temporarily disable it to load the Web page correctly.

- 2 Click **Settings** > **Network/Ports** > **Wireless**.
- 3 Modify the settings to match the settings of your access point (wireless router).  
**Note:** Make sure to enter the correct SSID, security method, preshared key or passphrase, network mode, and channel.
- 4 Click **Submit**.
- 5 Turn off the printer, and then disconnect the Ethernet cable. Then wait for at least five seconds, and then turn the printer back on.
- 6 To verify if your printer is connected to the network, print a network setup page. Then in the Network Card [x] section, see if the status is Connected.



## Verifying printer setup

When all hardware and software options are installed and the printer is turned on, verify that the printer is set up correctly by printing the following:

- **Menu settings page**—Use this page to verify that all printer options are installed correctly. A list of installed options appears toward the bottom of the page. If an option you installed is not listed, then it is not installed correctly. Remove the option, and then install it again.
- **Network setup page**—If your printer has Ethernet or wireless capability and is attached to a network, then print a network setup page to verify the network connection. This page also provides important information that aids network printing configuration.

### Printing a menu settings page

From the home screen, navigate to:



> **Reports > Menu Settings Page**

### Printing a network setup page

If the printer is attached to a network, then print a network setup page to verify the network connection. This page also provides important information that aids network printing configuration.

- 1 From the home screen, navigate to:



> **Reports > Network Setup Page**

- 2 Check the first section of the network setup page, and confirm that the status is **Connected**.

If the status is **Not Connected**, then the LAN drop may not be active, or the network cable may be malfunctioning. Consult a system support person for a solution, and then print another network setup page.

## Loading paper and specialty media

Proper selection and loading of media can improve how reliably documents print. For more information, see [“Avoiding jams” on page 235](#) and [“Storing paper” on page 58](#).

### Setting the paper size and type

From the home screen navigate to:



> **Paper Menu** > **Paper Size/Type** > select a tray > select the paper size or type > **Submit**

### Configuring Universal paper settings

The Universal paper size is a user-defined setting that lets you print on paper sizes that are not preset in the printer menus.

#### Notes:

- The smallest supported Universal size is 76 x 127 mm (3 x 5 inches) and is loaded only in the multipurpose feeder and manual feeder.
- The largest supported Universal size is 215.9 x 359.9 mm (8.5 x 14.17 inches) and is loaded only in the multipurpose feeder and manual feeder.

1 From the home screen, navigate to:



> **Paper Menu** > **Universal Setup** > **Units of Measure** > select a unit of measure

2 Touch **Portrait Width** or **Portrait Height**.

3 Select the width or height, and then touch **Submit**.

### Loading the 250- and 550-sheet tray

The printer has one 250-sheet tray (Tray 1) with an integrated manual feeder. The 250-sheet tray, the 650-sheet duo tray, and the 550-sheet tray support the same paper sizes and types and are loaded in the same way.



**CAUTION—POTENTIAL INJURY:** To reduce the risk of equipment instability, load each tray separately. Keep all other trays closed until needed.

1 Pull out the tray completely.

**Note:** Do not remove trays while a job is printing or while **Busy** appears on the display. Doing so may cause a jam.



- 2 If the paper is longer than letter-size paper, then squeeze and then slide the length guide at the back of the tray to extend it.

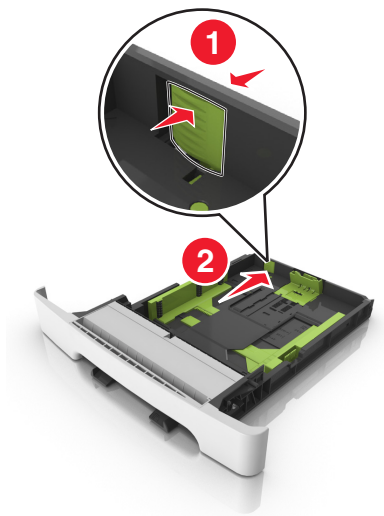

- 3 Squeeze, and then slide the length guide tab to the correct position for the size of the paper being loaded.

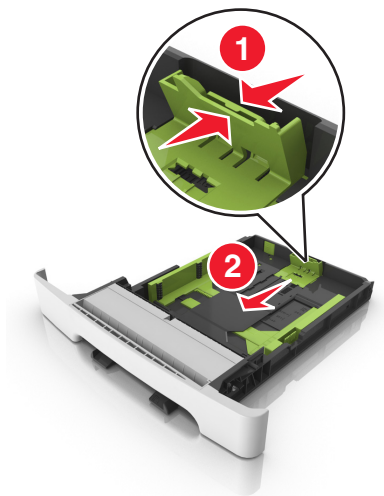

**Note:** Use the paper size indicators on the bottom of the tray to help position the guide.

- 4 Squeeze, and then slide the width guide tab to the correct position for the size of the paper being loaded.



**Note:** Use the paper size indicators on the bottom of the tray to help position the guides.

- 5 Flex the sheets back and forth to loosen them, and then fan them. Do not fold or crease the paper. Straighten the edges on a level surface.

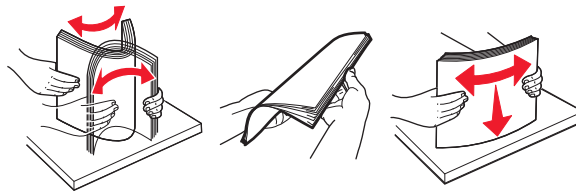

- 6 Load the paper stack with the recommended printable side faceup.

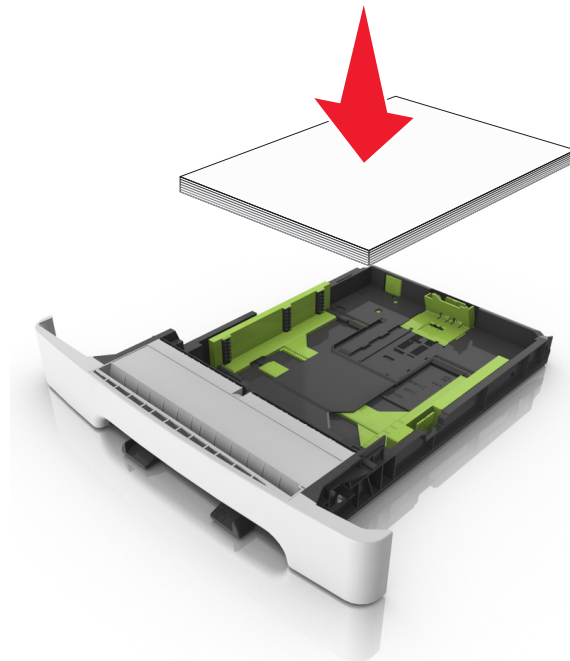

- 7 Place the paper guides securely against the edges of the paper.

8 Insert the tray.



9 From the printer control panel, set the paper size and paper type in the Paper menu to match the paper loaded in the tray.

**Note:** Mixing paper sizes or paper types in a tray may cause jams.

## Loading the manual feeder

The standard 250-sheet tray has an integrated manual feeder that can be used to print on different types of paper one sheet at a time.

1 Load a sheet of paper into the manual feeder:

- Printable side facedown for one-sided printing
- Printable side faceup for two-sided (duplex) printing

**Note:** There are different ways for loading letterhead depending on the mode of printing.

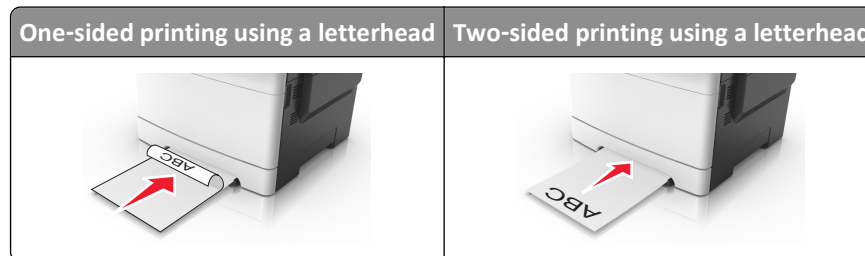

- Load envelope with the flap side up and against the right side of the paper guide.



2 Feed paper into the manual feeder only to the point where its leading edge can contact the paper guides.

**Note:** To achieve the best possible print quality, use only high-quality media designed for laser printers.

3 Adjust the paper guides to the width of the paper loaded.

**Warning—Potential Damage:** Do not force the paper into the feeder. Forcing the paper may cause jams.



## Loading the 650-sheet duo tray

The 650-sheet duo tray (Tray 2) consists of a 550-sheet tray and an integrated 100-sheet multipurpose feeder. The tray is loaded in the same way as the 250-sheet tray and the optional 550-sheet tray, and supports the same paper types and sizes. The only differences are the look of the guide tabs and the location of the paper size indicators.

**⚠ CAUTION—POTENTIAL INJURY:** To reduce the risk of equipment instability, load each tray separately. Keep all other trays closed until needed.

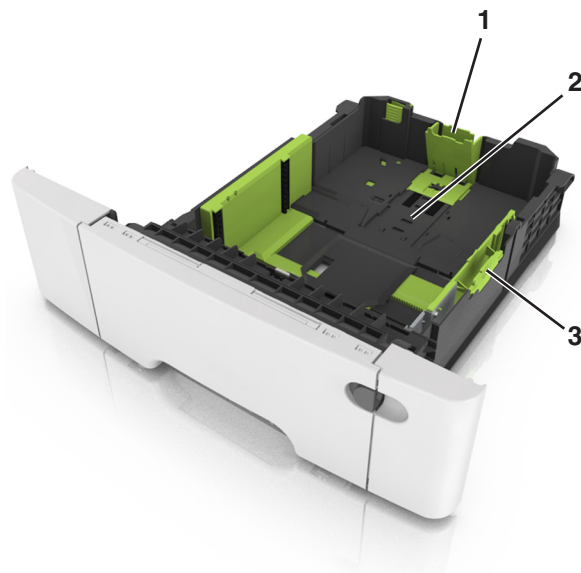

1	Length guide tab
2	Paper size indicator
3	Width guide tab

## Loading the multipurpose feeder

- 1 Push the multipurpose feeder latch to the left.

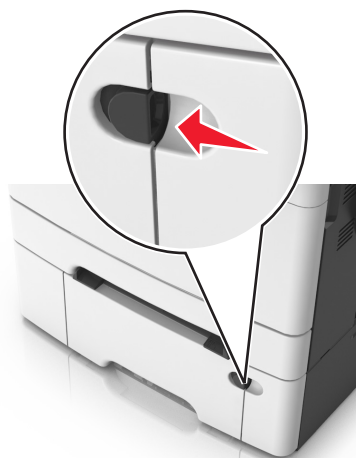

- 2 Open the multipurpose feeder.



- 3 Pull the multipurpose feeder extender.

**Note:** Guide the extender gently so that the multipurpose feeder is fully extended and open.



4 Prepare the paper for loading.

- Flex the sheets of paper back and forth to loosen them, and then fan them. Do not fold or crease the paper. Straighten the edges on a level surface.

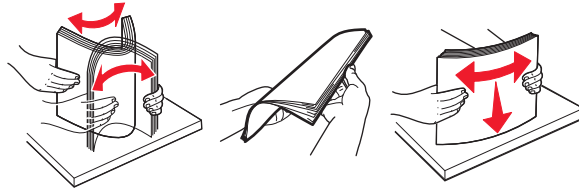

- Hold transparencies by the edges, and then fan them. Straighten the edges on a level surface.

**Note:** Avoid touching the printable side of transparencies. Be careful not to scratch them.

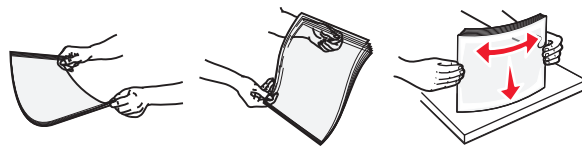

- Flex a stack of envelopes back and forth to loosen them, and then fan them. Straighten the edges on a level surface.

**Warning—Potential Damage:** Never use envelopes with stamps, clasps, snaps, windows, coated linings, or self-stick adhesives. These envelopes may severely damage the printer.



5 Locate the maximum paper fill indicator and tab.

**Note:** Make sure the paper or specialty media is below the maximum paper fill indicator located on the paper guides.

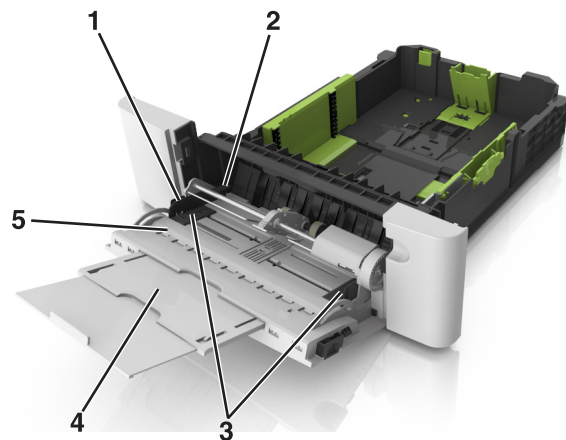

1	Width guide tab
2	Maximum paper fill indicator
3	Width guide
4	Feeder extender



5	Paper size indicator
---	----------------------

6 Load the paper, and then adjust the width guide to lightly touch the edge of the paper stack.

- Load paper, card stock, and transparencies with the recommended printable side facedown and the top edge entering the printer first.



- Load envelopes with the flap side up and against the right side of the paper guide.

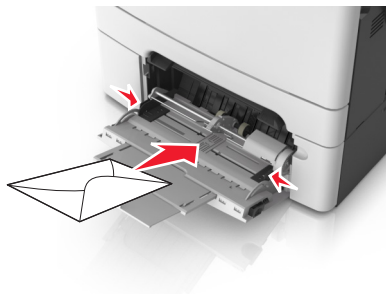

**Notes:**

- Do not load or close the multipurpose feeder while a job is printing.
- Load only one size and type of paper at a time.
- Paper should lie flat in the multipurpose feeder. Make sure the paper fits loosely in the multipurpose feeder and is not bent or wrinkled.

7 From the printer control panel, set the paper size and type in the Paper menu to match the paper loaded in the tray.

## Linking and unlinking trays

The printer links trays when the specified paper size and type are the same. When a linked tray becomes empty, paper feeds from the next linked tray. To prevent trays from linking, assign a unique custom paper type name.

### Linking and unlinking trays

1 Open a Web browser, and then type the printer IP address in the address field.

**Notes:**

- View the printer IP address on the printer home screen. The IP address appears as four sets of numbers separated by periods, such as 123.123.123.123.

- If you are using a proxy server, then temporarily disable it to load the Web page correctly.

**2** Click **Settings > Paper Menu**.

**3** Change the paper size and type settings for the trays you are linking.

- To link trays, make sure the paper size and type for the tray match that of the other tray.
- To unlink trays, make sure the paper size or type for the tray does *not* match that of the other tray.

**4** Click **Submit**.

**Note:** You can also change the paper size and type settings using the printer control panel. For more information, see [“Setting the paper size and type” on page 42](#).

**Warning—Potential Damage:** Paper loaded in the tray should match the paper type name assigned in the printer. The temperature of the fuser varies according to the specified paper type. Printing issues may occur if settings are not properly configured.

## Creating a custom name for a paper type

### Using the Embedded Web Server

**1** Open a Web browser, and then type the printer IP address in the address field.

**Notes:**

- View the printer IP address on the printer home screen. The IP address appears as four sets of numbers separated by periods, such as 123.123.123.123.
- If you are using a proxy server, then temporarily disable it to load the Web page correctly.

**2** Click **Settings > Paper Menu > Custom Names**.

**3** Select a custom name, and then type a custom paper type name.

**4** Click **Submit**.

**5** Click **Custom Types**, and then verify if the new custom paper type name has replaced the custom name.

### Using the printer control panel

**1** From the home screen, navigate to:



**> Paper Menu > Custom Names**

**2** Select a custom name, and then type a custom paper type name.

**3** Touch **Submit**.

**4** Touch **Custom Types**, and then verify if the new custom paper type name has replaced the custom name.

## Assigning a custom paper type

### Using the Embedded Web Server

Assign a custom paper type name to a tray when linking or unlinking trays.

**1** Open a Web browser, and then type the printer IP address in the address field.

**Notes:**

- View the printer IP address on the printer home screen. The IP address appears as four sets of numbers separated by periods, such as 123.123.123.123.
- If you are using a proxy server, then temporarily disable it to load the Web page correctly.

**2** Click **Settings > Paper Menu > Custom Types**.

**3** Select a custom paper type name, and then select a paper type.

**Note:** Paper is the factory default paper type for all user-defined custom names.

**4** Click **Submit**.

**Using the printer control panel**

**1** From the home screen, navigate to:



**> Paper Menu > Custom Types**

**2** Select a custom paper type name, and then select a paper type.

**Note:** Paper is the factory default paper type for all user-defined custom names.

**3** Touch **Submit**.

**Configuring a custom name****Using the Embedded Web Server**

**1** Open a Web browser, and then type the printer IP address in the address field.

**Notes:**

- View the printer IP address on the printer home screen. The IP address appears as four sets of numbers separated by periods, such as 123.123.123.123.
- If you are using a proxy server, then temporarily disable it to load the Web page correctly.

**2** Click **Settings > Paper Menu > Custom Types**.

**3** Select a custom name you want to configure, then select a paper or specialty media type, and then click **Submit**.

**Using the printer control panel**

**1** From the home screen, navigate to:



**> Paper Menu > Custom Types**

**2** Select a custom name you want to configure, and then touch **Submit**.

# Paper and specialty media guide



## Notes:

- Make sure that the paper size, type, and weight are set correctly on the computer or on the control panel.
- Flex, fan, and straighten specialty media before loading them.
- The printer may print at a reduced speed to prevent damage to the fuser.
- For more information on card stock and labels, see the *Card Stock & Label Guide* on the Lexmark support Web site at <http://support.lexmark.com>.





## Using specialty media

### Tips on using letterhead

- Use letterhead designed specifically for laser printers.
- Print a test page on the letterhead being considered for use before buying large quantities.
- Before loading letterhead, flex, fan, and straighten the stacks to prevent sheets from sticking together.
- Page orientation is important when printing on letterhead.

Source	Printing	Printable side	Paper orientation
Trays 	One-sided	Faceup	Load the sheet with the top edge entering the printer first.
Trays 	Two-sided	Facedown	Load the sheet with the bottom edge entering the printer first.

**Note:** Check with the manufacturer or vendor to determine whether or not the preprinted letterhead is acceptable for laser printers.

Source	Printing	Printable side	Paper orientation
<p>Manual feeder</p> 	One-sided	Facedown	Load the sheet with the top edge entering the printer first.
<p>Manual feeder</p> 	Two-sided	Faceup	Load the sheet with the bottom edge entering the printer first.
<p>Multipurpose feeder</p> 	One-sided	Facedown	Load the sheet with the top edge entering the printer first.
<p>Multipurpose feeder</p> 	Two-sided	Faceup	Load the sheet with the bottom edge entering the printer first.
<p><b>Note:</b> Check with the manufacturer or vendor to determine whether or not the preprinted letterhead is acceptable for laser printers.</p>			

## Tips on using transparencies

Print a test page on the transparencies being considered for use before buying large quantities.

- From the printer control panel, set the paper size, type, texture, and weight in the Paper menu to match the transparencies loaded in the tray.
- Print a test page on the transparencies being considered for use before buying large quantities.
- Feed transparencies from the 250-sheet tray, manual feeder, or multipurpose feeder.
- Use transparencies designed specifically for laser printers.
- Avoid getting fingerprints on the transparencies to prevent print quality problems.
- Before loading transparencies, flex, fan, and straighten the stacks to prevent sheets from sticking together.

## Tips on using envelopes

- From the printer control panel, set the paper size, type, texture, and weight in the Paper menu to match the envelopes loaded in the tray.
- Print samples on the envelopes being considered for use before buying large quantities.
- Use envelopes designed specifically for laser printers.
- For best performance, use envelopes made from 90-g/m<sup>2</sup> (24-lb) paper or 25% cotton.
- Use only new envelopes from undamaged packages.
- To optimize performance and minimize jams, do not use envelopes that:
  - Have excessive curl or twist.
  - Are stuck together or damaged in any way.
  - Have windows, holes, perforations, cutouts, or embossing.
  - Have metal clasps, string ties, or folding bars.
  - Have an interlocking design.
  - Have postage stamps attached.
  - Have any exposed adhesive when the flap is in the sealed or closed position.
  - Have bent corners.
  - Have rough, cockle, or laid finishes.
- Adjust the width guides to fit the width of the envelopes.
- Before loading the envelopes on the tray, flex and fan the envelopes to loosen them. Straighten the edges on a level surface.

**Note:** A combination of high humidity (over 60%) and high printing temperature may wrinkle or seal envelopes.

## Tips on using labels

- From the printer control panel, set the paper size, type, texture, and weight in the Paper menu to match the labels loaded in the tray.
- Print samples on labels being considered for use before buying large quantities.
- For more information on label printing, characteristics, and design, see the *Card Stock & Label Guide* at <http://support.lexmark.com>.
- Use labels designed specifically for laser printers.
- Do not use labels with slick backing material.

- Use full label sheets. Partial sheets may cause labels to peel off during printing, resulting in a jam. Partial sheets also contaminate the printer and the cartridge with adhesive, and could void the printer and toner cartridge warranties.
- Do not use labels with exposed adhesive.
- Before loading labels on the tray, flex and fan labels to loosen them. Straighten the edges on a level surface.

## Tips on using card stock

Card stock is heavy, single-ply specialty media. Many of its variable characteristics, such as moisture content, thickness, and texture, can significantly affect print quality.

- From the printer control panel, set the paper size, type, texture, and weight in the Paper menu to match the card stock loaded in the tray.
- Print samples on the card stock being considered for use before buying large quantities.
- Specify the paper texture and weight from the tray settings to match the paper loaded in the tray.
- Preprinting, perforation, and creasing may significantly affect the print quality and cause jams or other paper feed problems.
- Before loading the card stock on the tray, flex and fan the card stock to loosen them. Straighten the edges on a level surface.

## Paper guidelines

Select the correct paper or specialty media to reduce printing problems. For the best print quality, try a sample of the paper or specialty media before buying large quantities.

### Paper characteristics

The following paper characteristics affect print quality and reliability. Consider these characteristics when evaluating new paper stock.

#### Weight

The printer trays can automatically feed paper weights up to 176-g/m<sup>2</sup> (47-lb) bond grain long paper. The multipurpose feeder can automatically feed paper weights up to 176-g/m<sup>2</sup> (47-lb) bond grain long paper. Paper lighter than 60 g/m<sup>2</sup> (16 lb) might not be stiff enough to feed properly, causing jams. For best performance, use 75-g/m<sup>2</sup> (20-lb) bond grain long paper. For paper smaller than 182 x 257 mm (7.2 x 10.1 inches), we recommend 90 g/m<sup>2</sup> (24 lb) or heavier paper.

**Note:** Duplex printing is supported from 60–105-g/m<sup>2</sup> (16–28-lb) bond grain long paper.

#### Curl

Curl is the tendency for paper to curl at its edges. Excessive curl can cause paper feeding problems. Curl can occur after the paper passes through the printer, where it is exposed to high temperatures. Storing paper unwrapped in hot, humid, cold, or dry conditions, even in the trays, can contribute to paper curling prior to printing and can cause feeding problems.

## Smoothness

Paper smoothness directly affects print quality. If paper is too rough, then toner cannot fuse to it properly. If paper is too smooth, then it can cause paper feeding or print quality issues. Always use paper between 100 and 300 Sheffield points; smoothness between 150 and 250 Sheffield points produces the best print quality.

## Moisture content

The amount of moisture in paper affects both print quality and the ability of the printer to feed the paper correctly. Leave paper in its original wrapper until it is time to use it. This limits the exposure of paper to moisture changes that can degrade its performance.

Store paper in its original wrapper in the same environment as the printer for 24 to 48 hours before printing. Extend the time to several days if the storage or transportation environment is very different from the printer environment. Thick paper may also require a longer conditioning period.

## Grain direction

Grain refers to the alignment of the paper fibers in a sheet of paper. Grain is either *grain long*, running the length of the paper, or *grain short*, running the width of the paper.

For 60–90-g/m<sup>2</sup> (16–24-lb) bond paper, grain long paper is recommended.

## Fiber content

Most high-quality xerographic paper is made from 100% chemically treated pulped wood. This content provides the paper with a high degree of stability resulting in fewer paper feeding problems and better print quality. Paper containing fibers such as cotton can negatively affect paper handling.

## Unacceptable paper

The following paper types are not recommended for use with the printer:

- Chemically treated papers used to make copies without carbon paper, also known as carbonless papers, carbonless copy paper (CCP), or no carbon required (NCR) paper
- Preprinted papers with chemicals that may contaminate the printer
- Preprinted papers that can be affected by the temperature in the printer fuser
- Preprinted papers that require a registration (the precise print location on the page) greater than  $\pm 2.3$  mm ( $\pm 0.9$  in.), such as optical character recognition (OCR) forms

In some cases, registration can be adjusted with a software application to successfully print on these forms.

- Coated papers (erasable bond), synthetic papers, thermal papers
- Rough-edged, rough or heavily textured surface papers, or curled papers
- Recycled papers that fail EN12281:2002 (European)
- Paper weighing less than 60 g/m<sup>2</sup> (16 lb)
- Multiple-part forms or documents

## Selecting paper

Using the appropriate paper prevents jams and helps ensure trouble-free printing.



To help avoid paper jams and poor print quality:

- *Always* use new, undamaged paper.
- Before loading paper, know the recommended printable side of the paper. This information is usually indicated on the paper package.
- *Do not* use paper that has been cut or trimmed by hand.
- *Do not* mix paper sizes, types, or weights in the same tray; mixing results in jams.
- *Do not* use coated papers unless they are specifically designed for electrophotographic printing.

## Selecting preprinted forms and letterhead

Use these guidelines when selecting preprinted forms and letterhead:

- Use grain long for 60–90-g/m<sup>2</sup> (16–24-lb) paper.
- Use only forms and letterhead printed using an offset lithographic or engraved printing process.
- Avoid paper with rough or heavily textured surfaces.

Use inks that are not affected by the resin in toner. Inks that are oxidation-set or oil-based generally meet these requirements; latex inks might not.

When in doubt, contact your paper supplier.

## Using recycled paper and other office papers

As an environmentally conscious company, Lexmark supports the use of recycled office paper produced specifically for use in laser (electrophotographic) printers. In 1998, Lexmark presented to the US government a study demonstrating that recycled paper produced by major mills in the US fed as well as non-recycled paper. However, no blanket statement can be made that *all* recycled paper will feed well.

Lexmark consistently tests its printers with recycled paper (20–100% post-consumer waste) and a variety of test paper from around the world, using chamber tests for different temperature and humidity conditions. Lexmark has found no reason to discourage the use of today's recycled office papers, but generally the following property guidelines apply to recycled paper.

- Low moisture content (4–5%)
- Suitable smoothness (100–200 Sheffield units, or 140–350 Bendtsen units, European)

**Note:** Some much smoother papers (such as premium 24 lb laser papers, 50–90 Sheffield units) and much rougher papers (such as premium cotton papers, 200–300 Sheffield units) have been engineered to work very well in laser printers, despite surface texture. Before using these types of paper, consult your paper supplier.

- Suitable sheet-to-sheet coefficient of friction (0.4–0.6)
- Sufficient bending resistance in the direction of feed

Recycled paper, paper of lower weight (<60 g/m<sup>2</sup> [16 lb bond]) and/or lower caliper (<3.8 mils [0.1 mm]), and paper that is cut grain-short for portrait (or short-edge) fed printers may have lower bending resistance than is required for reliable paper feeding. Before using these types of paper for laser (electrophotographic) printing, consult your paper supplier. Remember that these are general guidelines only and that paper meeting these guidelines may still cause paper feeding problems in any laser printer (for example, if the paper curls excessively under normal printing conditions).

## Storing paper

Use these paper storage guidelines to help avoid jams and uneven print quality:

- For best results, store paper where the temperature is 21°C (70°F) and the relative humidity is 40 percent. Most label manufacturers recommend printing in a temperature range of 18–24°C (65–75°F) with relative humidity between 40 and 60 percent.
- Store paper in cartons, on a pallet or shelf, rather than on the floor.
- Store individual packages on a flat surface.
- Do not store anything on top of individual paper packages.
- Take paper out of the carton or wrapper only when you are ready to load it in the printer. The carton and wrapper help keep the paper clean, dry, and flat.

## Supported paper sizes, types, and weights

The following tables provide information on standard and optional paper sources and the sizes, types, and weights of paper they support.

**Note:** For an unlisted paper size, select the closest *larger* listed size.

### Supported paper sizes

**Note:** Your printer model may have a 650-sheet duo tray, which consists of a 550-sheet tray and an integrated 100-sheet multipurpose feeder. The 550-sheet tray of the 650-sheet duo tray supports the same paper sizes as the optional 550-sheet tray. The integrated multipurpose feeder supports different paper sizes, types, and weights.

Paper size and dimension	Standard 250-sheet tray	Manual feeder	650-sheet duo tray		550-sheet tray	ADF	Scanner glass	Duplex mode
			550-sheet tray	Multipurpose feeder				
<b>A4</b> 210 x 297 mm (8.3 x 11.7 in.)	√ <sup>1</sup>	√	√ <sup>1</sup>	√ <sup>1</sup>	√ <sup>1</sup>	√	√	√
<b>A5</b> 148 x 210 mm (5.83 x 8.3 in.)	√ <sup>1</sup>	√	√ <sup>2</sup>	√ <sup>1</sup>	√ <sup>2</sup>	√	√	X
<b>A6</b> 105 x 148 mm (4.1 x 5.8 in.)	X	√	X	√ <sup>1</sup>	X	X	√	X

<sup>1</sup> The paper source supports paper size without *size sensing*.

<sup>2</sup> Universal is supported in the standard 250- and optional 550-sheet trays only if the paper size is from 148 x 215.9 mm (5.83 x 8.5 in.) to 215.9 x 355.6 mm (8.5 x 14 in.).

<sup>3</sup> Universal is supported in the multipurpose feeder and manual feeder only if the paper size is from 76.2 x 127 mm (3 x 5 in.) to 215.9 x 359.9 mm (8.5 x 14.17 in.).

<sup>4</sup> Universal is supported in duplex mode only if the width is from 210 mm (8.27 in.) to 215.9 mm (8.5 in.), and the length is from 279.4 mm (11 in.) to 355.6 mm (14 in.).

Paper size and dimension	Standard 250-sheet tray	Manual feeder	650-sheet duo tray		550-sheet tray	ADF	Scanner glass	Duplex mode
			550-sheet tray	Multipurpose feeder				
<b>JIS B5</b> 182 x 257 mm (7.2 x 10.1 in.)	√ <sup>1</sup>	√	√ <sup>1</sup>	√ <sup>1</sup>	√ <sup>1</sup>	√	√	X
<b>Letter</b> 216 x 279 mm (8.5 x 11 in.)	√ <sup>1</sup>	√	√ <sup>1</sup>	√ <sup>1</sup>	√ <sup>1</sup>	√	√	√
<b>Legal</b> 216 x 356 mm (8.5 x 14 in.)	√ <sup>1</sup>	√	√ <sup>1</sup>	√ <sup>1</sup>	√ <sup>1</sup>	√	X	√
<b>Executive</b> 184 x 267 mm (7.3 x 10.5 in.)	√ <sup>1</sup>	√	√ <sup>1</sup>	√ <sup>1</sup>	√ <sup>1</sup>	√	√	X
<b>Oficio (Mexico)</b> 216 x 340 mm (8.5 x 13.4 in.)	√ <sup>1</sup>	√	√ <sup>1</sup>	√ <sup>1</sup>	√ <sup>1</sup>	√	X	√
<b>Folio</b> 216 x 330 mm (8.5 x 13 in.)	√ <sup>1</sup>	√	√ <sup>1</sup>	√ <sup>1</sup>	√ <sup>1</sup>	√	X	√
<b>Statement</b> 140 x 216 mm (5.5 x 8.5 in.)	X	√	X	√ <sup>1</sup>	X	√	√	X
<b>Universal</b> 76 x 127 mm (3 x 5 in.) to 216 x 356 mm (8.5 x 14 in.)	X	√ <sup>1,3</sup>	X	√ <sup>1,3</sup>	X	√	√	X
<b>Universal</b> 148 x 210 mm (5.8 x 8.3 in.) to 216 x 356 mm (8.5 x 14 in.)	√ <sup>1,2</sup>	√	√ <sup>1,2</sup>	√	√ <sup>1,2</sup>	X	X	√ <sup>4</sup>

<sup>1</sup> The paper source supports paper size without *size sensing*.

<sup>2</sup> Universal is supported in the standard 250- and optional 550-sheet trays only if the paper size is from 148 x 215.9 mm (5.83 x 8.5 in.) to 215.9 x 355.6 mm (8.5 x 14 in.).

<sup>3</sup> Universal is supported in the multipurpose feeder and manual feeder only if the paper size is from 76.2 x 127 mm (3 x 5 in.) to 215.9 x 359.9 mm (8.5 x 14.17 in.).

<sup>4</sup> Universal is supported in duplex mode only if the width is from 210 mm (8.27 in.) to 215.9 mm (8.5 in.), and the length is from 279.4 mm (11 in.) to 355.6 mm (14 in.).

Paper size and dimension	Standard 250-sheet tray	Manual feeder	650-sheet duo tray		550-sheet tray	ADF	Scanner glass	Duplex mode
			550-sheet tray	Multipurpose feeder				
<b>7 3/4 Envelope (Monarch)</b> 98 x 191 mm (3.9 x 7.5 in.)	X	✓	X	✓ <sup>1</sup>	X	X	X	X
<b>9 Envelope</b> 98 x 225 mm (3.9 x 8.9 in.)	X	✓	X	✓ <sup>1</sup>	X	X	X	X
<b>10 Envelope</b> 105 x 241 mm (4.1 x 9.5 in.)	X	✓	X	✓ <sup>1</sup>	X	X	X	X
<b>DL Envelope</b> 110 x 220 mm (4.3 x 8.7 in.)	X	✓	X	✓ <sup>1</sup>	X	X	X	X
<b>C5 Envelope</b> 162 x 229 mm (6.4 x 9 in.)	X	✓	X	✓ <sup>1</sup>	X	X	X	X
<b>B5 Envelope</b> 176 x 250 mm (6.9 x 9.8 in.)	X	✓	X	✓ <sup>1</sup>	X	X	X	X
<b>Other Envelope</b> 98 x 162 mm (3.9 x 6.3 in.) up to 176 x 250 mm (6.9 x 9.8 in.)	X	✓	X	✓ <sup>1</sup>	X	X	X	X

<sup>1</sup> The paper source supports paper size without *size sensing*.

<sup>2</sup> Universal is supported in the standard 250- and optional 550-sheet trays only if the paper size is from 148 x 215.9 mm (5.83 x 8.5 in.) to 215.9 x 355.6 mm (8.5 x 14 in.).

<sup>3</sup> Universal is supported in the multipurpose feeder and manual feeder only if the paper size is from 76.2 x 127 mm (3 x 5 in.) to 215.9 x 359.9 mm (8.5 x 14.17 in.).

<sup>4</sup> Universal is supported in duplex mode only if the width is from 210 mm (8.27 in.) to 215.9 mm (8.5 in.), and the length is from 279.4 mm (11 in.) to 355.6 mm (14 in.).

## Supported paper types and weights

### Notes:

- Your printer model may have a 650-sheet duo tray, which consists of a 550-sheet tray and an integrated 100-sheet multipurpose feeder. The 550-sheet tray of the 650-sheet duo tray supports the same paper as the 550-sheet tray. The integrated multipurpose feeder supports different paper sizes, types, and weights.
- Labels, envelopes, and card stock always print at reduced speed.

Paper type	250-sheet tray	Manual feeder	650-sheet duo tray		550-sheet tray	ADF	Scanner glass	Two-sided printing
			550-sheet tray	Multipurpose feeder				
<b>Paper</b> <ul style="list-style-type: none"> <li>• Plain</li> <li>• Recycled</li> <li>• Glossy</li> <li>• Bond</li> <li>• Letterhead</li> <li>• Preprinted</li> <li>• Colored</li> <li>• Light</li> <li>• Heavy</li> <li>• Custom Type [x]</li> </ul>	✓	✓	✓	✓	✓	✓	✓	✓
<b>Card stock</b>	✓	✓	✓	✓	✓	✓	✓	x
<b>Labels</b> <ul style="list-style-type: none"> <li>• Paper</li> </ul>	✓	✓	✓	✓	✓	✓	✓	x
<b>Envelope</b>	x	✓	x	✓	x	✓	✓	x

# Printing

## Printing forms

Use Forms and Favorites to quickly and easily access frequently used forms or other information that is regularly printed. Before you can use this application, first set it up on the printer. For more information, see [“Setting up Forms and Favorites” on page 21](#).

- 1 From the home screen, navigate to:  
**Forms and Favorites** > select the form from the list > enter the number of copies > adjust other settings
- 2 Apply the changes.

## Printing a document

### Printing a document

- 1 From the printer control panel, set the paper type and size to match the paper loaded.
- 2 Send the print job:

#### For Windows users

- a With a document open, click **File** > **Print**.
- b Click **Properties**, **Preferences**, **Options**, or **Setup**.
- c Adjust the settings, if necessary.
- d Click **OK** > **Print**.

#### For Macintosh users

- a Customize the settings in the Page Setup dialog:
  - 1 With a document open, choose **File** > **Page Setup**.
  - 2 Choose a paper size or create a custom size to match the paper loaded.
  - 3 Click **OK**.
- b Customize the settings in the Print dialog:
  - 1 With a document open, choose **File** > **Print**.  
If necessary, click the disclosure triangle to see more options.
  - 2 From the print options pop-up menus, adjust the settings, if necessary.  
**Note:** To print on a specific paper type, adjust the paper type setting to match the paper loaded, or select the appropriate tray or feeder.
  - 3 Click **Print**.

## Printing in black and white

From the home screen, navigate to:



> **Settings** > **Print Settings** > **Quality Menu** > **Print Mode** > **Black Only** > **Submit**

## Adjusting toner darkness

1 Open a Web browser, and then type the printer IP address in the address field.

### Notes:

- View the printer IP address on the printer home screen. The IP address appears as four sets of numbers separated by periods, such as 123.123.123.123.
- If you are using a proxy server, then temporarily disable it to load the Web page correctly.

2 Click **Settings** > **Print Settings** > **Quality Menu** > **Toner Darkness**.

3 Adjust the toner darkness, and then click **Submit**.

## Using the printer control panel

1 From the home screen, navigate to:



> **Settings** > **Print Settings** > **Quality Menu** > **Toner Darkness**

2 Adjust the setting, and then touch **Submit**.

## Using Max Speed and Max Yield

Max Speed and Max Yield let you choose between a faster print speed or a higher toner yield. Max Yield is the factory default setting.

- **Max Speed**—This lets you print in either black or color depending on what is set in the printer driver. The printer prints in color unless Black Only is selected in the printer driver.
- **Max Yield**—This lets you switch from black to color based on the color content found on each page. Frequent color mode switching can result to slower printing if the content of pages is mixed.

## Using the Embedded Web Server

1 Open a Web browser, and then type the printer IP address in the address field.

### Notes:

- View the printer IP address on the printer home screen. The IP address appears as four sets of numbers separated by periods, such as 123.123.123.123.
- If you are using a proxy server, then temporarily disable it to load the Web page correctly.

2 Click **Settings** > **Print Settings** > **Setup Menu**.

3 From the Printer Usage list, select **Max Speed** or **Max Yield**.

4 Click **Submit**.

## Using the printer control panel

- 1 From the home screen, navigate to:



> **Settings** > **Print Settings** > **Setup Menu**

- 2 From the Printer Usage list, select **Max Speed** or **Max Yield**.
- 3 Touch **Submit**.

## Printing from a flash drive or mobile device

### Printing from a flash drive

#### Notes:

- Before printing an encrypted PDF file, you will be prompted to type the file password from the printer control panel.
- You cannot print files for which you do not have printing permissions.

- 1 Insert a flash drive into the USB port.



#### Notes:

- A flash drive icon appears on the printer home screen when a flash drive is inserted.
- If you insert the flash drive when the printer requires attention, such as when a jam has occurred, then the printer ignores the flash drive.
- If you insert the flash drive while the printer is processing other print jobs, then **Busy** appears on the printer display. After these print jobs are processed, you may need to view the held jobs list to print documents from the flash drive.

**Warning—Potential Damage:** Do not touch the USB cable, any wireless network adapter, any connector, the memory device, or the printer in the areas shown while actively printing, reading, or writing from the memory device. Loss of data can occur.



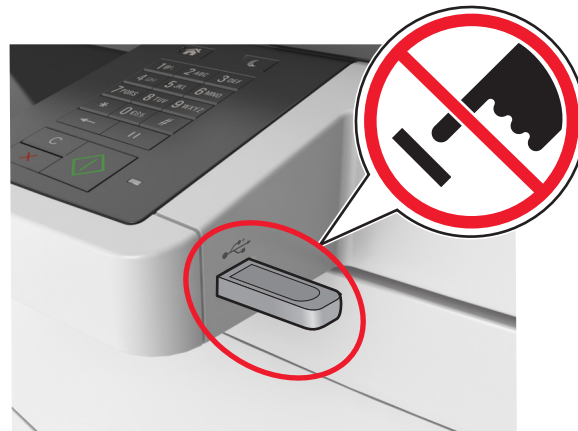

- 2 From the printer control panel, touch the document you want to print.
- 3 Touch the arrows to get a preview of the document.
- 4 Use **+** or **-** to specify the number of copies to be printed, and then touch **Print**.

**Notes:**

- Do not remove the flash drive from the USB port until the document has finished printing.
- If you leave the flash drive in the printer after leaving the initial USB menu screen, then touch **Held Jobs** on the home screen to print files from the flash drive.

## Supported flash drives and file types

**Notes:**

- High-speed USB flash drives must support the full-speed standard. Low-speed USB devices are not supported.
- USB flash drives must support the File Allocation Table (FAT) system. Devices formatted with New Technology File System (NTFS) or any other file system are not supported.

Recommended flash drives	File type
<ul style="list-style-type: none"> <li>• Lexar JumpDrive FireFly (512MB and 1GB)</li> <li>• SanDisk Cruzer Micro (512MB and 1GB)</li> <li>• Sony Micro Vault Classic (512MB and 1GB)</li> </ul>	<p>Documents:</p> <ul style="list-style-type: none"> <li>• .pdf</li> <li>• .xps</li> </ul> <p>Images:</p> <ul style="list-style-type: none"> <li>• .dcx</li> <li>• .gif</li> <li>• .jpeg or .jpg</li> <li>• .bmp</li> <li>• .pcx</li> <li>• .tiff or .tif</li> <li>• .png</li> <li>• .fls</li> </ul>

## Printing from a mobile device

To download a compatible mobile printing application, visit [www.lexmark.com/mobile](http://www.lexmark.com/mobile).

**Note:** Mobile printing applications may also be available from your mobile device manufacturer.

## Printing confidential and other held jobs

### Storing print jobs in the printer

1 From the printer control panel, navigate to:



> **Security** > **Confidential Print** > select the print job type

Use	To
Max Invalid PIN	Limit the number of times an invalid PIN can be entered. <b>Note:</b> When the limit is reached, the print jobs for that user name and PIN are deleted.
Confidential Job Expiration	Hold print jobs in the computer until you enter the PIN from the printer control panel. <b>Note:</b> The PIN is set from the computer. It must be four digits, using the numbers 1–9.
Repeat Job Expiration	Print and store print jobs in the printer memory.
Verify Job Expiration	Print one copy of a print job and hold the remaining copies. It allows you to examine if the first copy is satisfactory. The print job is automatically deleted from the printer memory when all copies are printed.
Reserve Job Expiration	Store print jobs for printing at a later time. <b>Note:</b> The print jobs are held until deleted from the Held Jobs menu.
<b>Notes:</b> <ul style="list-style-type: none"> <li>• Confidential, Verify, Reserve, and Repeat print jobs may be deleted if the printer requires extra memory to process additional held jobs.</li> <li>• You can set the printer to store print jobs in the printer memory until you start the print job from the printer control panel.</li> <li>• All print jobs that can be initiated by the user at the printer are called <i>held jobs</i>.</li> </ul>	

2 Touch **Submit**.

## Printing confidential and other held jobs

**Note:** Confidential and Verify print jobs are automatically deleted from memory after printing. Repeat and Reserve jobs are *held* in the printer until you delete them.

### For Windows users

1 With a document open, click **File** > **Print**.

2 Click **Properties**, **Preferences**, **Options**, or **Setup**.

- 3 Click **Print and Hold**.
- 4 Select the print job type (Confidential, Repeat, Reserve, or Verify), and then assign a user name. For a confidential print job, also enter a four-digit PIN.
- 5 Click **OK** or **Print**.
- 6 From the printer home screen, release the print job.
  - For confidential print jobs, navigate to:  
**Held jobs** > select your user name > **Confidential Jobs** > enter the PIN > **Print**
  - For other print jobs, navigate to:  
**Held jobs** > select your user name > select the print job > specify the number of copies > **Print**

### For Macintosh users

- 1 With a document open, choose **File** > **Print**.  
If necessary, click the disclosure triangle to see more options.
- 2 From the print options or Copies & Pages pop-up menu, choose **Job Routing**.
- 3 Select the print job type (Confidential, Repeat, Reserve, or Verify), and then assign a user name. For a confidential print job, also enter a four-digit PIN.
- 4 Click **OK** or **Print**.
- 5 From the printer home screen, release the print job.
  - For confidential print jobs, navigate to:  
**Held jobs** > select your user name > **Confidential Jobs** > enter the PIN > **Print**
  - For other print jobs, navigate to:  
**Held jobs** > select your user name > select the print job > specify the number of copies > **Print**

## Modifying confidential print settings

- 1 Open a Web browser, and then type the printer IP address in the address field.

### Notes:

- View the printer IP address on the printer home screen. The IP address appears as four sets of numbers separated by periods, such as 123.123.123.123.
- If you are using a proxy server, then temporarily disable it to load the Web page correctly.

- 2 Click **Settings** > **Security** > **Confidential Print Setup**.
- 3 Modify the settings:
  - Set a maximum number of PIN entry attempts. When a user exceeds that number, all of the jobs for that user are deleted.
  - Set an expiration time for confidential print jobs. When a user has not printed the jobs within that time, all of the jobs for that user are deleted.
- 4 Click **Submit** to save the modified settings.

## Printing information pages

### Printing a font sample list

- 1 From the home screen, navigate to:



> Reports > Print Fonts

- 2 Touch **PCL Fonts** or **PostScript Fonts**.

### Printing a directory list

A directory list shows the resources stored in a flash memory or in the printer hard disk.

From the home screen, navigate to:



> Reports > Print Directory

## Canceling a print job

### Canceling a print job from the printer control panel

- 1 From the printer control panel, touch **Cancel Job** or press  on the keypad.
- 2 Touch the print job you want to cancel, and then touch **Delete Selected Jobs**.

**Note:** If you press  on the keypad, then touch **Resume** to return to the home screen.

### Canceling a print job from the computer



#### For Windows users

- 1 Open the printers folder, and then select your printer.
- 2 From the print queue, select the print job you want to cancel, and then delete it.

#### For Macintosh users

- 1 From System Preferences in the Apple menu, navigate to your printer.
- 2 From the print queue, select the print job you want to cancel, and then delete it.

# Copying

Automatic document feeder (ADF)	Scanner glass
 <p>Use the ADF for multiple-page documents including two-sided pages.</p>	 <p>Use the scanner glass for single-page documents, book pages, small items (such as postcards or photos), transparencies, photo paper, or thin media (such as magazine clippings).</p>

## Making copies

### Making a quick copy

- 1 Load an original document faceup, short edge first into the ADF tray or facedown on the scanner glass.

**Notes:**

- Do not load postcards, photos, small items, transparencies, photo paper, or thin media (such as magazine clippings) into the ADF tray. Place these items on the scanner glass.
- The ADF indicator light comes on when the paper is loaded properly.

- 2 If you are loading a document into the ADF tray, then adjust the paper guides.

**Note:** To avoid a cropped image, make sure the size of the original document and the size of the copy paper are the same.

- 3 From the printer control panel, press .

### Copying using the ADF

- 1 Load an original document faceup, short edge first into the ADF tray.

**Notes:**

- Do not load postcards, photos, small items, transparencies, photo paper, or thin media (such as magazine clippings) into the ADF tray. Place these items on the scanner glass.

- The ADF indicator light comes on when the paper is loaded properly.

2 Adjust the paper guides.

3 From the home screen, navigate to:

**Copy** > specify the copy settings > **Copy It**

## Copying using the scanner glass

1 Place an original document facedown on the scanner glass in the upper left corner.

2 From the home screen, navigate to:

**Copy** > specify the copy settings > **Copy It**

If you have more pages to scan, then place the next document on the scanner glass, and then touch **Scan the next page**.

3 Touch **Finish the Job**.

## Copying photos

1 Place a photo facedown on the scanner glass in the upper left corner.

2 From the home screen, navigate to:

**Copy** > **Content** > **Photo** > 

3 From the Content Source menu, select the appropriate setting that best matches the original photo.

4 Touch  > **Copy It**

**Note:** If you have more photos to copy, then place the next photo on the scanner glass, and then touch **Scan the next page**.

5 Touch **Finish the Job**.

## Copying on specialty media

### Copying on transparencies

1 Load an original document faceup, short edge first into the ADF tray or facedown on the scanner glass.

**Notes:**

- Do not load postcards, photos, small items, transparencies, photo paper, or thin media (such as magazine clippings) into the ADF tray. Place these items on the scanner glass.
- The ADF indicator light comes on when the paper is loaded properly.



2 From the home screen, navigate to:

**Copy** > **Copy from** > select the size of the original document > 

3 Navigate to:

**Copy to** > select the tray that contains transparencies > **Copy It**

If there are no trays that contain transparencies, then navigate to:

**Manual Feeder** >  > select the size of the transparencies >  > **Transparency** > 

4 Load transparencies into the multipurpose feeder, and then touch **Copy It**.

## Copying on letterhead

1 Load an original document faceup, short edge first into the ADF tray or facedown on the scanner glass.

### Notes:

- Do not load postcards, photos, small items, transparencies, photo paper, or thin media (such as magazine clippings) into the ADF tray. Place these items on the scanner glass.
- The ADF indicator light comes on when the paper is loaded properly.

2 If you are loading a document into the ADF tray, then adjust the paper guides.

3 From the home screen, navigate to:

**Copy** > **Copy from** > select the size of the original document > 

4 Navigate to:

**Copy to** > select the tray containing the letterhead > **Copy It**

5 If there are no trays that support letterhead, then navigate to:

**Manual Feeder** > select the size of the letterhead > **Letterhead**

6 Load the letterhead faceup, top edge first into the multipurpose feeder, and then touch **Copy It**.

## Creating a copy shortcut using the printer control panel

1 From the home screen, touch **Copy**.

2 Adjust the copy settings, and then touch **Save as Shortcut**.

**Note:** If you change the settings after the copy shortcut has been created, then the settings are not saved.

3 Type a unique name for the shortcut, and then touch **Done**.

4 Verify that the shortcut name is correct, and then touch **OK**.

If the shortcut name is incorrect, then touch **Cancel**, and then reenter the information.

### Notes:

- The shortcut name appears in the Copy Shortcuts icon on the printer home screen.
- You can use the shortcut when copying another document using the same settings.

## Customizing copy settings

### Copying to a different size

- 1 Load an original document faceup, short edge first into the ADF tray or facedown on the scanner glass.

**Notes:**

- Do not load postcards, photos, small items, transparencies, photo paper, or thin media (such as magazine clippings) into the ADF tray. Place these items on the scanner glass.
- The ADF indicator light comes on when the paper is loaded properly.

- 2 If you are loading a document into the ADF tray, then adjust the paper guides.

- 3 From the home screen, navigate to:

**Copy** > **Copy from** > select the size of the original document > 

- 4 Navigate to:

**Copy to** > select a new size for the copy >  > **Copy It**

### Making copies using paper from a selected tray

- 1 Load an original document faceup, short edge first into the ADF tray or facedown on the scanner glass.

**Notes:**

- Do not load postcards, photos, small items, transparencies, photo paper, or thin media (such as magazine clippings) into the ADF tray. Place these items on the scanner glass.
- The ADF indicator light comes on when the paper is loaded properly.

- 2 If you are loading a document into the ADF tray, then adjust the paper guides.

- 3 From the home screen, navigate to:

**Copy** > **Copy from** > select the size of the original document > 

- 4 Navigate to:

**Copy to** > select the tray containing the paper type you want to use > 

- 5 Touch **Copy It**.

### Copying different paper sizes

Use the ADF to copy original documents with different paper sizes. Depending on the paper sizes loaded and the “Copy to” and “Copy from” settings, each copy is either printed on mixed paper sizes (Example 1) or scaled to fit a single paper size (Example 2).

#### Example 1: Copying on mixed paper sizes

- 1 Load an original document faceup, short edge first into the ADF tray or facedown on the scanner glass.



**Notes:**

- Do not load postcards, photos, small items, transparencies, photo paper, or thin media (such as magazine clippings) into the ADF tray. Place these items on the scanner glass.
- The ADF indicator light comes on when the paper is loaded properly.

2 If you are loading a document into the ADF tray, then adjust the paper guides.

3 From the home screen, navigate to:

**Copy > Copy from > Mixed Sizes > **

4 Navigate to:

**Copy to > Auto Size Match >  > Copy It**

The scanner identifies the different paper sizes as they are scanned. Copies are printed on mixed paper sizes corresponding to the paper sizes of the original document.

**Example 2: Copying on a single paper size**

1 Load an original document faceup, short edge first into the ADF tray or facedown on the scanner glass.

**Notes:**

- Do not load postcards, photos, small items, transparencies, photo paper, or thin media (such as magazine clippings) into the ADF tray. Place these items on the scanner glass.
- The ADF indicator light comes on when the paper is loaded properly.

2 If you are loading a document into the ADF tray, then adjust the paper guides.

3 From the home screen, navigate to:

**Copy > Copy from > Mixed Sizes > **

4 Navigate to:

**Copy to > Letter >  > Copy It**

The scanner identifies the different paper sizes as they are scanned, and then scales the mixed paper sizes to fit on the paper size selected.

**Copying on both sides of the paper (duplexing)**

1 Load an original document faceup, short edge first into the ADF tray or facedown on the scanner glass.

**Notes:**

- Do not load postcards, photos, small items, transparencies, photo paper, or thin media (such as magazine clippings) into the ADF tray. Place these items on the scanner glass.
- The ADF indicator light comes on when the paper is loaded properly.

2 If you are loading a document into the ADF tray, then adjust the paper guides.

3 From the home screen, navigate to:

**Copy > Sides (Duplex)** > select the preferred duplexing method

**Note:** For the preferred duplexing method, the first number represents sides of the original documents while the second number represents sides of the copy. For example, select “2 sided to 2 sided” if you have two-sided original documents and you want two-sided copies.

4 Touch  > **Copy It.**

## Reducing or enlarging copies

Copies can be scaled from 25% to 400% of the original document size.

1 Load an original document faceup, short edge first into the ADF tray or facedown on the scanner glass.

**Notes:**

- Do not load postcards, photos, small items, transparencies, photo paper, or thin media (such as magazine clippings) into the ADF tray. Place these items on the scanner glass.
- The ADF indicator light comes on when the paper is loaded properly.

2 If you are loading a document into the ADF tray, then adjust the paper guides.

3 From the home screen, touch **Copy**.

4 From the Scale area, touch  or  to decrease or increase the value by 1%.

Touching “Copy to” or “Copy from” after setting Scale manually changes the scale value back to Auto.

**Note:** Auto is the factory default setting. This automatically adjusts the scan image of the original document to fit the size of the paper onto which you are copying.

5 Touch **Copy It.**

## Adjusting copy quality

1 Load an original document faceup, short edge first into the ADF tray or facedown on the scanner glass.

**Notes:**

- Do not load postcards, photos, small items, transparencies, photo paper, or thin media (such as magazine clippings) into the ADF tray. Place these items on the scanner glass.
- The ADF indicator light comes on when the paper is loaded properly.

2 If you are loading a document into the ADF tray, then adjust the paper guides.

3 From the home screen, navigate to:

**Copy > Content**

4 Touch the button that best represents the content type of the document you are copying.

- **Text**—The content of the original document is mostly text or line art.
- **Text/Photo**—The original document is a mixture of text, graphics, and photos.
- **Photo**—The original document is mostly a photo or an image.
- **Graphics**—The original document is mostly business-type graphics, such as pie charts, bar charts, and animations.

5 Touch .



6 Touch the button that best represents the content source of the document you are copying.

- **Color Laser**—The original document was printed using a color laser printer.
- **Inkjet**—The original document was printed using an inkjet printer.
- **Magazine**—The original document is from a magazine.
- **Press**—The original document was printed using a printing press.
- **Black/White Laser**—The original document was printed using a mono laser printer.
- **Photo/Film**—The original document is a photo from a film.
- **Newspaper**—The original document is from a newspaper.
- **Other**—The original document was printed using an alternate or unknown printer.

7 Touch  > **Copy It**.

## Collating copies

If you print multiple copies of a document, then you can choose to print the copies as a set (collated) or to print the copies as groups of pages (not collated).

Collated	Not collated
	

1 Load an original document faceup, short edge first into the ADF tray or facedown on the scanner glass.

### Notes:

- Do not load postcards, photos, small items, transparencies, photo paper, or thin media (such as magazine clippings) into the ADF tray. Place these items on the scanner glass.
- The ADF indicator light comes on when the paper is loaded properly.

2 If you are loading a document into the ADF tray, then adjust the paper guides.

3 From the home screen, navigate to:

**Copy** > enter the number of copies > **Collate** > select the preferred order of pages >  > **Copy It**

## Placing separator sheets between copies

1 Load an original document faceup, short edge first into the ADF tray or facedown on the scanner glass.

### Notes:

- Do not load postcards, photos, small items, transparencies, photo paper, or thin media (such as magazine clippings) into the ADF tray. Place these items on the scanner glass.
- The ADF indicator light comes on when the paper is loaded properly.

2 If you are loading a document into the ADF tray, then adjust the paper guides.

3 From the home screen, navigate to:

**Copy > Advanced Options > Separator Sheets**

**Note:** Set Collate to “1,2,3 - 1,2,3” to place separator sheets between copies. If Collate is set to “1,1,1 - 2,2,2,” then the separator sheets are added to the end of the copy job. For more information, see [“Collating copies” on page 75](#).

4 Select one of the following:

- **Between Copies**
- **Between Jobs**
- **Between Pages**
- **Off**

5 Touch  > **Copy It**.

## Copying multiple pages onto a single sheet

In order to save paper, you can copy either two or four consecutive pages of a multiple-page document onto a single sheet of paper.

### Notes:

- Make sure to set the paper size to letter, legal, A4, or JIS B5.
- Make sure to set the copy size to 100%.

1 Load an original document faceup, short edge first into the ADF tray or facedown on the scanner glass.

### Notes:

- Do not load postcards, photos, small items, transparencies, photo paper, or thin media (such as magazine clippings) into the ADF tray. Place these items on the scanner glass.
- The ADF indicator light comes on when the paper is loaded properly.

2 If you are loading a document into the ADF tray, then adjust the paper guides.

3 From the home screen, navigate to:

**Copy > Advanced Options > Paper Saver > select the output you want >  > Copy It**

**Note:** If Paper Saver is set to Off, then the Print Page Borders option is unavailable.

## Creating a custom copy job

The custom copy job or job build is used to combine one or more sets of original documents into a single copy job. Each set may be scanned using different job parameters. When a copy job is submitted and Custom Job is enabled, the scanner scans the first set of original documents using the specified settings, and then it scans the next set with the same or different settings.

The definition of a set depends on the scan source:

- If you scan a document on the scanner glass, then a set consists of one page.
- If you scan multiple pages using the ADF, then a set consists of all scanned pages until the ADF tray becomes empty.
- If you scan one page using the ADF, then a set consists of one page.

For example:

- 1 Load an original document faceup, short edge first into the ADF tray or facedown on the scanner glass.

**Notes:**

- Do not load postcards, photos, small items, transparencies, photo paper, or thin media (such as magazine clippings) into the ADF tray. Place these items on the scanner glass.
- The ADF indicator light comes on when the paper is loaded properly.

- 2 If you are loading a document into the ADF tray, then adjust the paper guides.

- 3 From the home screen, navigate to:

**Copy > Advanced Options > Custom Job > On >  > Copy It**

**Note:** When the end of a set is reached, the scan screen appears.

- 4 Load the next document faceup, short edge first into the ADF tray or facedown on the scanner glass, and then touch **Scan from automatic feeder** or **Scan from flatbed**.

**Note:** Change the scan job settings, if necessary.

- 5 If you have another document to scan, then repeat the previous step. Otherwise, touch **Finish the job**.

## Placing information on copies

### Placing a header or footer on pages

- 1 Load an original document faceup, short edge first into the ADF tray or facedown on the scanner glass.

**Notes:**



- Do not load postcards, photos, small items, transparencies, photo paper, or thin media (such as magazine clippings) into the ADF tray. Place these items on the scanner glass.
- The ADF indicator light comes on when the paper is loaded properly.

- 2 If you are loading a document into the ADF, then adjust the paper guides.

- 3 From the home screen, navigate to:

**Copy > Advanced Options > Header/Footer > select where you want to place the header or footer > select the type of header or footer you want**

- 4 Enter the required information depending on the header or footer you selected, and then touch **Done**.

- 5 Touch , and then press .

### Placing an overlay message on each page

An overlay message can be placed on each page. The message choices are Urgent, Confidential, Copy, Custom, and Draft.

- 1 Load an original document faceup, short edge first into the ADF tray or facedown on the scanner glass.

**Notes:**

- Do not load postcards, photos, small items, transparencies, photo paper, or thin media (such as magazine clippings) into the ADF tray. Place these items on the scanner glass.
  - The ADF indicator light comes on when the paper is loaded properly.
- 2 If you are loading a document into the ADF tray, then adjust the paper guides.
  - 3 From the home screen, navigate to:  
**Copy > Advanced Options > Overlay > select overlay message > Done > Copy It**

## Canceling a copy job

### Canceling a copy job while the original document is in the ADF

When the ADF begins processing a document, touch **Cancel Job** on the printer control panel.

### Canceling a copy job while copying pages using the scanner glass

From the home screen, touch **Cancel Job**.

**Canceling** appears on the display. When the job is canceled, the Copy screen appears.

### Canceling a copy job while pages are being printed

- 1 From the printer control panel, touch **Cancel Job** or press  on the keypad.
- 2 Touch the job you want to cancel, and then touch **Delete Selected Jobs**.

**Note:** If you press  on the keypad, then touch **Resume** to return to the home screen.

## Understanding the copy options

### Copy from

This option lets you select the paper size of the original document.

- Touch the paper size that matches the original document.
- To copy an original document that contains mixed paper sizes with the same width, touch **Mixed Sizes**.

### Copy to



This option lets you select the size and type of paper on which your copies will be printed.

- Touch the paper size and type that matches the paper loaded.
- If the settings for “Copy from” and “Copy to” are different, then the printer automatically adjusts the Scale setting to accommodate the difference.

- If the type or size of paper you want to use is not loaded in one of the trays, then touch **Manual Feeder**, and manually load the paper in the manual feeder or multipurpose feeder.
- When “Copy to” is set to Auto Size Match, each copy matches the paper size of the original document. If a matching paper size is not in one of the trays, then **Paper size not found** appears and prompts to load a paper in a tray, manual feeder, or multipurpose feeder.

## Scale

This option lets you scale the document from 25% to 400% of the original document size. You can also set automatic scaling.

- When copying to a different paper size, such as from legal-size to letter-size paper, set the “Copy from” and “Copy to” paper sizes automatically to scale the scan image to fit the size of the paper onto which you are copying.
- To decrease or increase the value by 1%, touch  or  on the printer control panel. To make a continuous decrease or increase in value, hold the button for two seconds or more.

## Darkness

This option lets you adjust how light or dark the copies are in relation to the original document.

## Copies

This option lets you set the number of copies to be printed.

## Sides (Duplex)

This option lets you make one- or two-sided copies from one- or two-sided original documents.

## Collate

This option keeps the pages of a print job stacked in sequence when printing multiple copies of the document.

## Content

This option lets you set the original document type and source.

Select from the following content types:

- **Graphics**—The original document is mostly business-type graphics such as pie charts, bar charts, and animations.
- **Photo**—The original document is mostly a photo or an image.
- **Text**—The content of the original document is mostly text or line art.
- **Text/Photo**—The original document is a mixture of text, graphics, and photos.

Select from the following content sources:

- **Black/White Laser**—The original document was printed using a mono laser printer.
- **Color Laser**—The original document was printed using a color laser printer.
- **Inkjet**—The original document was printed using an inkjet printer.
- **Magazine**—The original document is from a magazine.

- **Newspaper**—The original document is from a newspaper.
- **Other**—The original document was printed using an alternate or unknown printer.
- **Photo/Film**—The original document is a photo from film.
- **Press**—The original document was printed using a printing press.

## Color

This option lets you set the output to either color or monochrome for the scanned image.



## Save As Shortcut

This option lets you save the current settings by assigning a shortcut name.

**Note:** Selecting this option automatically assigns the next available shortcut number.

## Using the advanced options



Select from the following settings:

- **Adjust ADF Skew**—This straightens scanned images that are slightly skewed when received from the ADF tray.
- **Advanced Duplex**—This specifies the document orientation, whether documents are one-sided or two-sided, and how documents are bound.
- **Advanced Imaging**—This adjusts the Auto Center, Background Removal, Color Balance, Color Dropout, Contrast, Mirror Image, Negative Image, Scan Edge to Edge, Shadow Detail, Sharpness, and Temperature settings before you copy the document.
- **Create Booklet**—This creates a booklet. You can choose between one-sided and two-sided.  
**Note:** This option appears only when a formatted, working printer hard disk is installed.
- **Cover Page Setup**—This sets up the cover page of copies and booklets.
- **Custom Job**—This combines multiple scanning jobs into a single job.  
**Note:** This option appears only when a formatted, working printer hard disk is installed.
- **Edge Erase**—This removes smudges or marks around the edges of a document. You can choose to remove an equal area around all four sides of the paper, or pick a particular edge. Edge Erase will erase whatever is within the area selected, leaving nothing on that portion of the scan.
- **Header/Footer**—This inserts Date/Time, Page number, Bates number, or Custom text, and then prints them in the specified header or footer location.
- **Margin Shift**—This increases or decreases the page margin by shifting the scanned image. Touch  or  to set the margin you want. If the additional margin is too large, then the copy will be cropped.
- **Overlay**—This creates a watermark (or message) that overlays the content of your copy. You can choose from Confidential, Copy, Draft, and Urgent, or you can enter a custom message in the "Enter custom text" field. The word you pick will appear, faintly, in large print across each page.



- 
- **Paper Saver**—This prints two or more pages of an original document on the same page. Paper Saver is also called *N-up* printing, where *N* stands for the number of pages. For example, 2-up would print two pages of your document on a single page, and 4-up would print four pages of your document on a single page.
  - **Separator Sheets**—This places a blank sheet of paper between copies, pages, or print jobs. The separator sheets can be drawn from a tray that contains a type or color of paper that is different from the paper your copies are printed on.

## E-mailing

Automatic document feeder (ADF)	Scanner glass
 <p data-bbox="149 856 753 917">Use the ADF for multiple-page documents including two-sided pages.</p>	 <p data-bbox="773 829 1463 917">Use the scanner glass for single-page documents, book pages, small items (such as postcards or photos), transparencies, photo paper, or thin media (such as magazine clippings).</p>

## Setting up the printer to e-mail

### Setting up the e-mail function

- 1 Open a Web browser, and then type the printer IP address in the address field.

**Notes:**

- View the printer IP address on the printer home screen. The IP address appears as four sets of numbers separated by periods, such as 123.123.123.123.
- If you are using a proxy server, then temporarily disable it to load the Web page correctly.

- 2 Click **Settings > E-mail/FTP Settings > E-mail Settings**.
- 3 Enter the appropriate information, and then click **Submit**.

### Configuring e-mail settings

- 1 Open a Web browser, and then type the printer IP address in the address field.

**Notes:**

- View the printer IP address on the printer home screen. The IP address appears as four sets of numbers separated by periods, such as 123.123.123.123.
- If you are using a proxy server, then temporarily disable it to load the Web page correctly.

- 2 Click **Settings > E-mail/FTP Settings > E-mail Settings**.
- 3 Enter the appropriate information, and then click **Submit**.

## Creating an e-mail shortcut

### Creating an e-mail shortcut using the Embedded Web Server

- 1 Open a Web browser, and then type the printer IP address in the address field.

**Notes:**

- View the printer IP address on the printer home screen. The IP address appears as four sets of numbers separated by periods, such as 123.123.123.123.
- If you are using a proxy server, then temporarily disable it to load the Web page correctly.

- 2 Click **Settings**.
- 3 From the Other Settings column, click **Manage Shortcuts > E-mail Shortcut Setup**.
- 4 Type a unique name for the e-mail recipient, and then type the e-mail address. If you are entering multiple addresses, then separate each address with a comma.
- 5 Click **Add**.

### Creating an e-mail shortcut using the printer control panel

- 1 From the home screen, navigate to:  
**E-mail > Recipient** > type an e-mail address  
To create a group of recipients, touch **Next address**, and then type the next recipient's e-mail address.
- 2 Touch **Subject**, then type the e-mail subject, and then touch **Done**.
- 3 Touch **Message**, then type your message, and then touch **Done**.
- 4 Adjust the e-mail settings.  
**Note:** If you change the settings after the e-mail shortcut has been created, then the settings are not saved.

- 5 Touch .
- 6 Type a unique name for the shortcut, and then touch **Done**.
- 7 Verify that the shortcut name is correct, and then touch **OK**.  
If the shortcut name is incorrect, then touch **Cancel**, and then reenter the information.

**Notes:**

- The shortcut name appears in the E-mail Shortcuts icon on the printer home screen.
- You can use the shortcut when e-mailing another document using the same settings.

## E-mailing a document

**Note:** You can also send an e-mail by using the Multi Send or MyShortcut application from the home screen. For more information, see [“Activating the home screen applications” on page 21](#).

### Sending an e-mail using the printer control panel

- 1 Load an original document faceup, short edge first into the ADF tray or facedown on the scanner glass.

**Notes:**

- Do not load postcards, photos, small items, transparencies, photo paper, or thin media (such as magazine clippings) into the ADF tray. Place these items on the scanner glass.
- The ADF indicator light comes on when the paper is loaded properly.

- 2 If you are loading a document into the ADF tray, then adjust the paper guides.

**Note:** To avoid a cropped image, make sure that the size of the original document and the copy paper size are the same.

- 3 From the home screen, navigate to:

**E-mail > Recipient(s)**

- 4 Type the e-mail address, or press # using the keypad, and then enter the shortcut number.

**Notes:**

- To enter additional recipients, touch **Next address**, and then enter the address or shortcut number you want to add.
- You can also enter an e-mail address using the address book.

- 5 Touch **Done > Send It**.

### Sending an e-mail using a shortcut number

- 1 Load an original document faceup, short edge first into the ADF tray or facedown on the scanner glass.

**Notes:**

- Do not load postcards, photos, small items, transparencies, photo paper, or thin media (such as magazine clippings) into the ADF tray. Place these items on the scanner glass.
- The ADF indicator light comes on when the paper is loaded properly.

- 2 If you are loading a document into the ADF tray, then adjust the paper guides.

- 3 Press #, then enter the shortcut number using the keypad, and then touch .

**Note:** To enter additional recipients, touch **Next address**, and then enter the address or shortcut number that you want to add.

- 4 Touch **Send It**.

### Sending an e-mail using the address book

- 1 Load an original document faceup, short edge first into the ADF tray or facedown on the scanner glass.

**Notes:**

- Do not load postcards, photos, small items, transparencies, photo paper, or thin media (such as magazine clippings) into the ADF tray. Place these items on the scanner glass.
- The ADF indicator light comes on when the paper is loaded properly.

**2** If you are loading a document into the ADF tray, then adjust the paper guides.

**3** From the home screen, navigate to:

**E-mail > Recipient(s) >  > type the name of the recipient > Search**

**4** Touch the name of the recipient.

**Note:** To enter additional recipients, touch **Next address**, and then enter the address or shortcut number that you want to add, or search the address book.

**5** Touch **Done**.

## Customizing e-mail settings

### Adding e-mail subject and message information

**1** Load an original document faceup, short edge first into the ADF tray or facedown on the scanner glass.

**Notes:**

- Do not load postcards, photos, small items, transparencies, photo paper, or thin media (such as magazine clippings) into the ADF tray. Place these items on the scanner glass.
- The ADF indicator light comes on when the paper is loaded properly.

**2** If you are loading a document into the ADF tray, then adjust the paper guides.

**3** From the home screen, navigate to:

**E-mail > Recipient(s) > type the e-mail address > Done**

**4** Touch **Subject**, then type the e-mail subject, and then touch **Done**.

**5** Touch **Message**, then type your message, and then touch **Done**.

### Changing the output file type

**1** Load an original document into the ADF tray or on the scanner glass.

**2** From the home screen, navigate to:

**E-mail > Recipient(s) > type the e-mail address > Done > Send as**

**3** Select the file type you want to send.

**Note:** If you select Secure PDF, then you will be prompted to enter your password twice.

**4** Touch  > **Send It**.

## Canceling an e-mail

- When using the ADF, touch **Cancel Job** while **Scanning** appears.
- When using the scanner glass, touch **Cancel Job** while **Scanning** appears, or while **Scan the Next Page / Finish the Job** appears.

## Understanding the e-mail options

### Recipient(s)

This option lets you enter the recipient of your e-mail. You may enter multiple e-mail addresses.

### Subject

This option lets you type a subject line for your e-mail.

### Message

This option lets you type a message that will be sent with your scanned attachment.

### File Name

This option lets you customize the attachment file name.

### Original Size

This option lets you set the paper size of the documents you are going to e-mail. When Original Size is set to Mixed Sizes, you can scan an original document that contains mixed paper sizes (letter- and legal-size pages).

### Resolution

This option lets you adjust the output quality of your e-mail. Increasing the image resolution increases the e-mail file size and the time needed to scan your original document. Decreasing the image resolution reduces the file size.

### Color

This option lets you set the output to either color or monochrome for the scanned image.

### Content

This option lets you set the original document type and source.

Select from the following content types:

- **Graphics**—The original document is mostly business-type graphics, such as pie charts, bar charts, and animations.
- **Photo**—The original document is mostly a photo or an image.

- **Text**—The content of the original document is mostly text or line art.
- **Text/Photo**—The original document is a mixture of text, graphics, and photos.

Select from the following content sources:

- **Black/White Laser**—The original document was printed using a mono laser printer.
- **Color Laser**—The original document was printed using a color laser printer.
- **Inkjet**—The original document was printed using an inkjet printer.
- **Magazine**—The original document is from a magazine.
- **Newspaper**—The original document is from a newspaper.
- **Other**—The original document was printed using an alternate or unknown printer.
- **Photo/Film**—The original document is a photo from film.
- **Press**—The original document was printed using a printing press.

## Darkness

This option lets you adjust how light or dark your scanned documents are in relation to the original document.

## Send As

This option lets you set the output type for the scan image.

Select one of the following:

- **PDF**—Use this to create a single file with multiple pages. This can be sent as a secured or compressed file.
- **TIFF**—Use this to create multiple files or a single file. If Multi-page TIFF is turned off in the Settings menu of the Embedded Web Server, then TIFF saves one page in each file. The file size is usually larger than an equivalent JPEG.
- **JPEG**—Use this to create and attach a separate file for each page of your original document.
- **XPS**—Use this to create a single XPS file with multiple pages.
- **RTF**—Use this to create a file in editable format.
- **TXT**—Use this to create an ASCII text file with no formatting.

## Page Setup

This option lets you change the following settings:

- **Sides (Duplex)**—This specifies if the original document is printed on only one side or on both sides of the paper. This also identifies what needs to be scanned for inclusion in the e-mail.
- **Orientation**—This specifies the orientation of the original document, and then changes the Sides (Duplex) and Binding settings to match the orientation.
- **Binding**—This specifies if the original document is bound on the long-edge or short-edge side.

## Scan Preview

This option lets you view the first page of the image before it is included in the e-mail. When the first page is scanned, the scanning is paused and a preview image appears.

**Note:** This option appears only when a working printer hard disk is installed.

## Save As Shortcut

This option lets you save the current settings as a shortcut by assigning a shortcut name.

**Note:** Selecting this option automatically assigns the next available shortcut number.



## Using the advanced options

Select from the following settings:

- **Adjust ADF Skew**—This straightens scanned images that are slightly skewed when received from the ADF tray.
- **Advanced Imaging**—This adjusts the Background Removal, Color Balance, Color Dropout, Contrast, JPEG Quality, Mirror Image, Negative Image, Scan Edge to Edge, Shadow Detail, Sharpness, and Temperature settings before you e-mail the document.
- **Custom Job**—This combines multiple scanning jobs into a single job.  
**Note:** This option appears only when a formatted, working printer hard disk is installed.
- **Edge Erase**—This removes smudges or marks around the edges of a document. You can choose to remove an equal area around all four sides of the paper, or pick a particular edge. Edge Erase will erase whatever is within the area selected, leaving nothing on that portion of the scan.
- **Transmission Log**—This prints the transmission log or transmission error log.



## Faxing

Automatic document feeder (ADF)	Scanner glass
 <p data-bbox="149 856 751 919">Use the ADF for multiple-page documents including two-sided pages.</p>	 <p data-bbox="768 829 1471 919">Use the scanner glass for single-page documents, book pages, small items (such as postcards or photos), transparencies, photo paper, or thin media (such as magazine clippings).</p>

## Setting up the printer to fax

 **CAUTION—SHOCK HAZARD:** Do not use the fax feature during a lightning storm. Do not set up this product or make any electrical or cabling connections, such as the fax feature, power cord, or telephone, during a lightning storm.

### Notes:

- The following connection methods are applicable only in some countries or regions.
- During the initial printer setup, clear the fax function check box and any other function you plan to set up later, and then touch **Continue**.
- The indicator light may blink red if the fax function is enabled and not fully set up.

**Warning—Potential Damage:** Do not touch cables or the printer in the area shown while actively sending or receiving a fax.



## Initial fax setup

Many countries and regions require outgoing faxes to contain the following information in a margin at the top or bottom of each transmitted page, or on the first page of the transmission: fax name (identification of the business, other entity, or individual sending the message) and fax number (telephone number of the sending fax machine, business, other entity, or individual). For more information, see [“Regulatory notices for telecommunication terminal equipment” on page 321](#).

To enter your fax setup information, use the printer control panel, or use your browser to access the Embedded Web Server and then enter the Settings menu.

**Note:** If you do not have a TCP/IP environment, then you must use the printer control panel to enter your fax setup information.

### Using the printer control panel for fax setup

When the printer is turned on for the first time, a series of start-up screens appear. If the printer has fax capabilities, then the Fax Name and Fax Number screens appear.

- 1 When the Fax Name screen appears, do the following:
  - a Enter the name to be printed on all outgoing faxes.
  - b Enter the fax name, and then touch **Submit**.
- 2 When the Fax Number screen appears, enter the fax number, and then touch **Submit**.

### Using the Embedded Web Server for fax setup

- 1 Open a Web browser, and then type the printer IP address in the address field.

**Notes:**

- View the printer IP address on the printer home screen. The IP address appears as four sets of numbers separated by periods, such as 123.123.123.123.
- If you are using a proxy server, then temporarily disable it to load the Web page correctly.

- 2 Click **Settings > Fax Settings > Analog Fax Setup**.
- 3 In the Fax Name field, type the name to be printed on all outgoing faxes.

- 4 In the Fax Number field, enter the printer fax number.
- 5 Click **Submit**.

## Choosing a fax connection

### Scenario 1: Standard telephone line

#### Setup 1: Printer is connected to a dedicated fax line

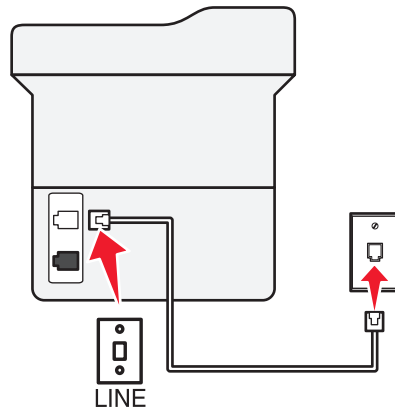
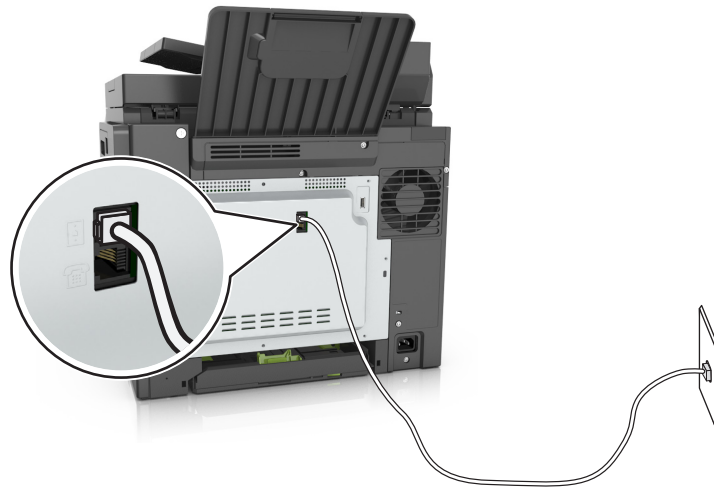

#### To connect:

- 1 Connect one end of the telephone cable that came with the printer to the  port of the printer.
- 2 Connect the other end of the telephone cable to an active analog wall jack.



#### Tips for this setup:

- You can set the printer to receive faxes automatically (Auto Answer On) or manually (Auto Answer Off).
- If you want to receive faxes automatically (Auto Answer On), then set the printer to pick up on any number of rings that you want.

**Setup 2: Printer is sharing the line with an answering machine**

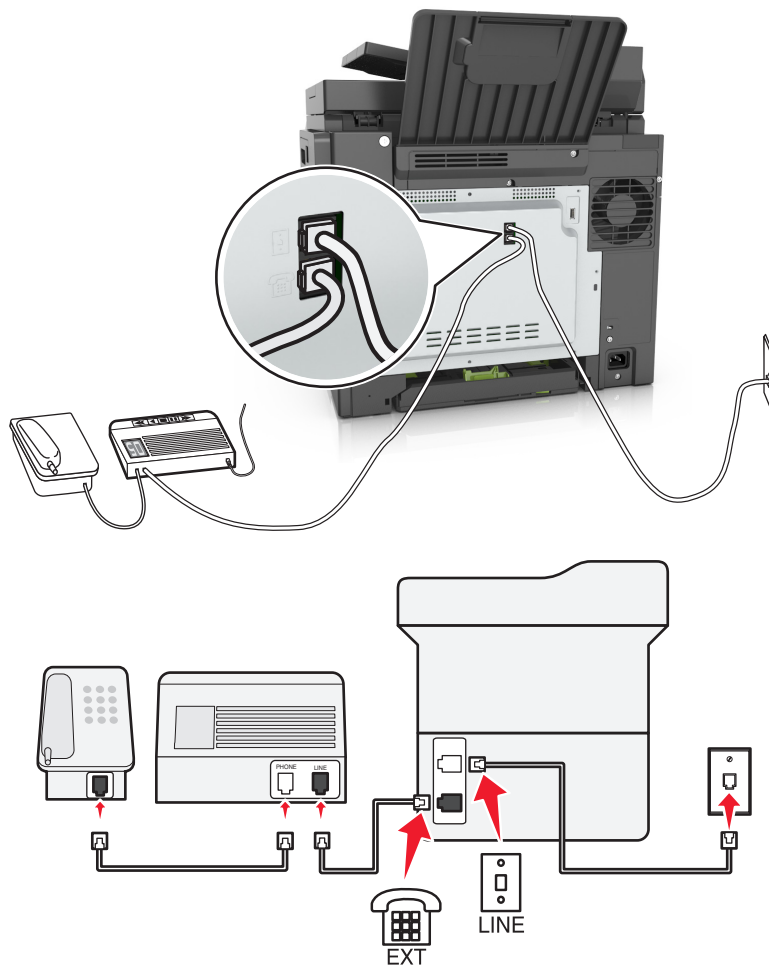
Connected to the same telephone wall jack

**To connect:**

- 1 Connect one end of the telephone cable that came with the printer to the  port of the printer.
- 2 Connect the other end of the telephone cable to an active analog wall jack.
- 3 Connect the answering machine to the  port of the printer.

### Connected to different wall jacks

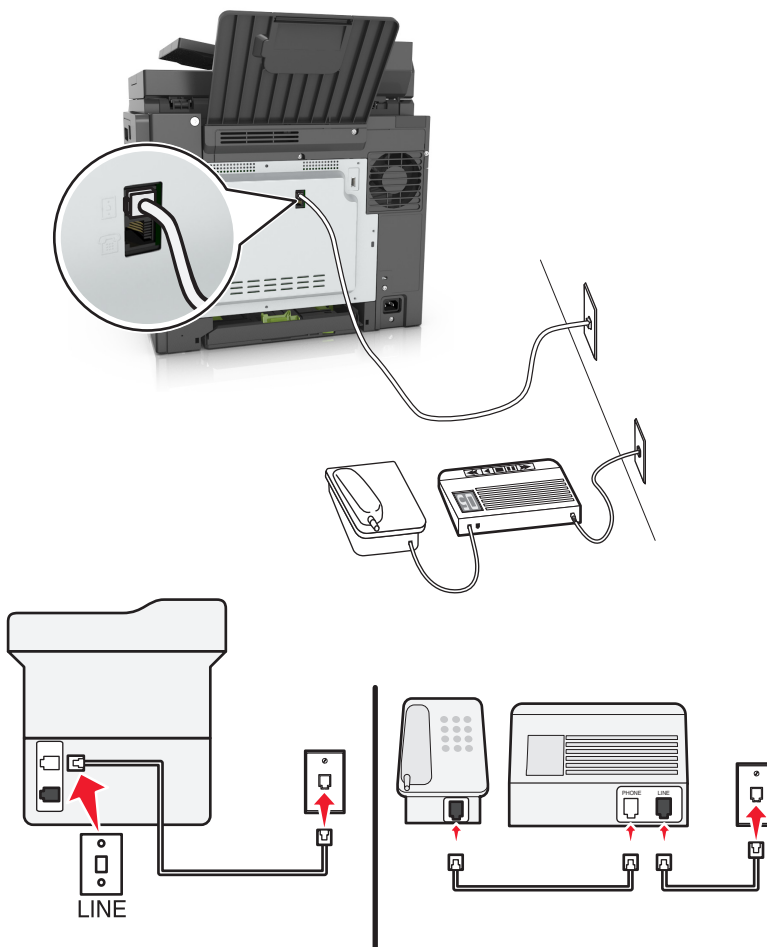

#### To connect:

- 1 Connect one end of the telephone cable that came with the printer to the  port of the printer.
- 2 Connect the other end of the telephone cable to an active analog wall jack.



#### Tips for this setup:

- If you have only one telephone number on your line, then you need to set the printer to receive faxes automatically (Auto Answer On).
- Set the printer to pick up calls two rings after the answering machine. For example, if the answering machine picks up calls after four rings, then set the printer to pick up after six rings. This way, the answering machine picks up calls first and your voice calls are received. If the call is a fax, then the printer detects the fax signal on the line and takes over the call.
- If you subscribe to a distinctive ring service provided by your telephone company, then make sure that you set the correct ring pattern for the printer. Otherwise, the printer does not receive faxes even if you have set it to receive faxes automatically.

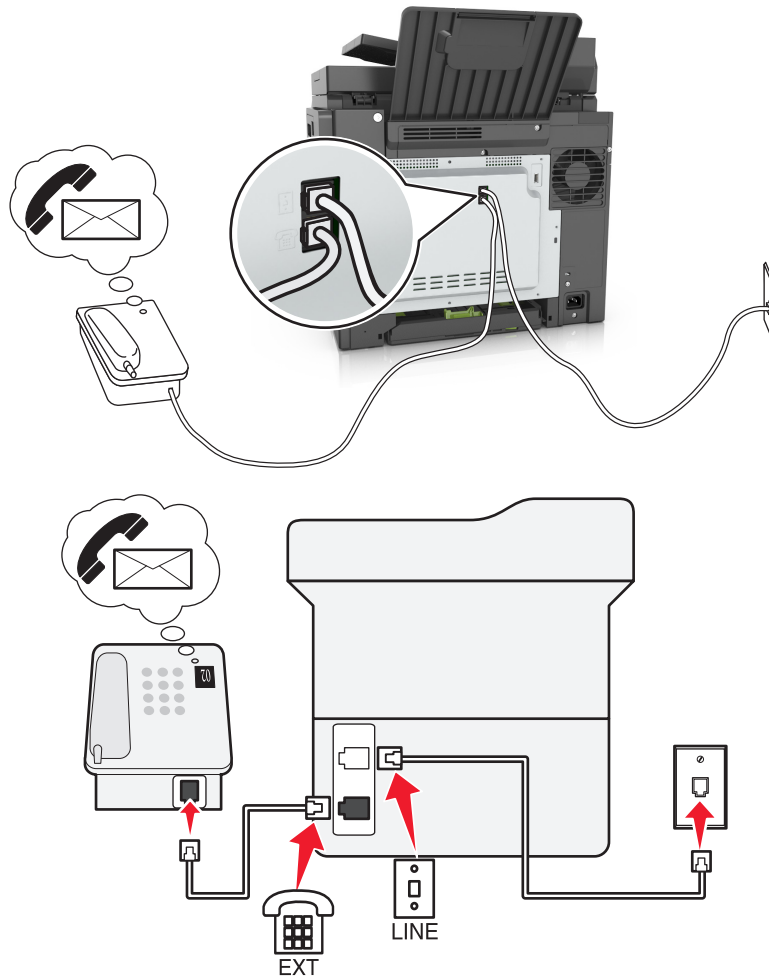
### Setup 3: Printer is sharing the line with a telephone subscribed to voice mail service



#### To connect:

- 1 Connect one end of the telephone cable that came with the printer to the  port of the printer.
- 2 Connect the other end of the telephone cable to an active analog wall jack.
- 3 Connect the telephone to the  port of the printer.

#### Tips for this setup:

- This setup works best if you subscribe to a distinctive ring service. If you have distinctive ring service, then make sure that you set the correct ring pattern for the printer. Otherwise, the printer does not receive faxes even if you have set it to receive faxes automatically.
- If you have only one telephone number on your line, then you need to set the printer to receive faxes manually (Auto Answer Off).

When you answer the telephone and you hear fax tones, press **\*9\*** or the manual answer code on the telephone to receive the fax.

- You can also set the printer to receive faxes automatically (Auto Answer On), but you need to turn off the voice mail service when you are expecting a fax. This setting works best if you are using voice mail more often than fax.

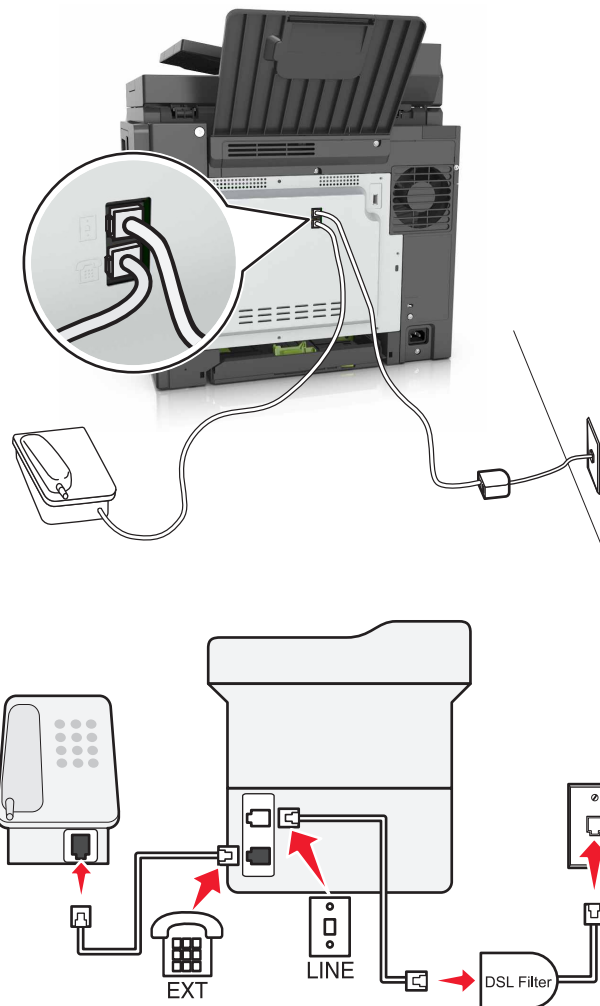

## Scenario 2: Digital Subscriber Line (DSL)



A Digital Subscriber Line splits your regular telephone line into two channels: voice and Internet. Telephone and fax signals travel through the voice channel, and Internet signals pass through the other channel. This way, you can use the same line for analog voice calls (including faxes) and digital Internet access.

To minimize interference between the two channels and ensure a quality connection, you need to install a DSL filter for the analog devices (fax machine, telephone, answering machine) in your network. Interference causes noise and static on the telephone, failed and poor quality faxes for the printer, and slow Internet connection on your computer.

To install a filter for the printer:

- 1 Connect the line port of the DSL filter to the wall jack.
- 2 Connect one end of the telephone cable that came with your printer to the  port of the printer. Connect the other end to the phone port on the DSL filter.
- 3 To continue using a computer for Internet access, connect the computer to the DSL HPN port on the DSL filter.
- 4 To connect a telephone to the printer, remove any installed adapter plug from the  port of the printer, and then connect the telephone to the port.

### Scenario 3: VoIP telephone service

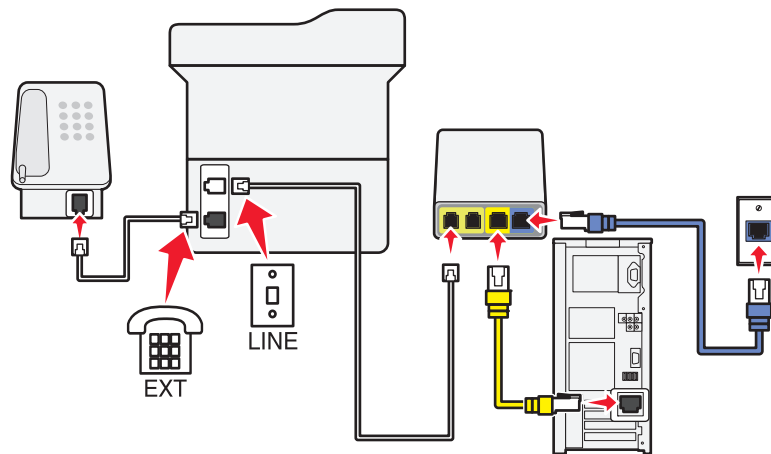
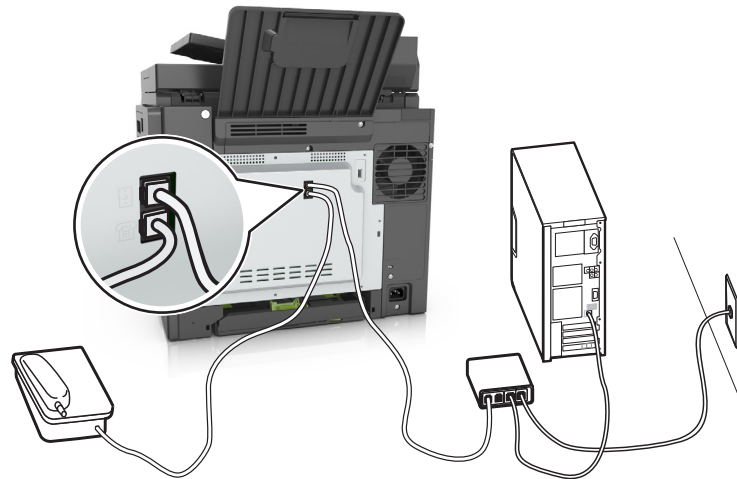

#### To connect:

- 1 Connect one end of the telephone cable that came with the printer to the  port of the printer.
- 2 Connect the other end of the cable to the port labeled **Phone Line 1** or **Phone Port** on the VoIP adapter.

**Note:** The port labeled **Phone Line 2** or **Fax Port** is not always active. VoIP providers may charge additional cost for activation of the second phone port.

- 3 Connect the telephone to the  port of the printer.

#### Tips for this setup:

- To make sure that the phone port on the VoIP adapter is active, plug an analog telephone into the phone port, and then listen for a dial tone. If you hear a dial tone, then the port is active.
- If you need two phone ports for your devices, but do not want to pay additional cost, then do not plug the printer into the second phone port. You can use a phone splitter. Plug the phone splitter into the port labeled **Phone Line 1** or **Phone Port**, and then plug the printer and telephone into the splitter.

**Note:** Make sure you use a phone splitter, *not* a line splitter. To make sure that you are using the correct splitter, plug an analog telephone into the splitter and then listen for a dial tone.



## Scenario 4: Digital telephone service through a cable provider

### Setup 1: Printer is connected directly to a cable modem

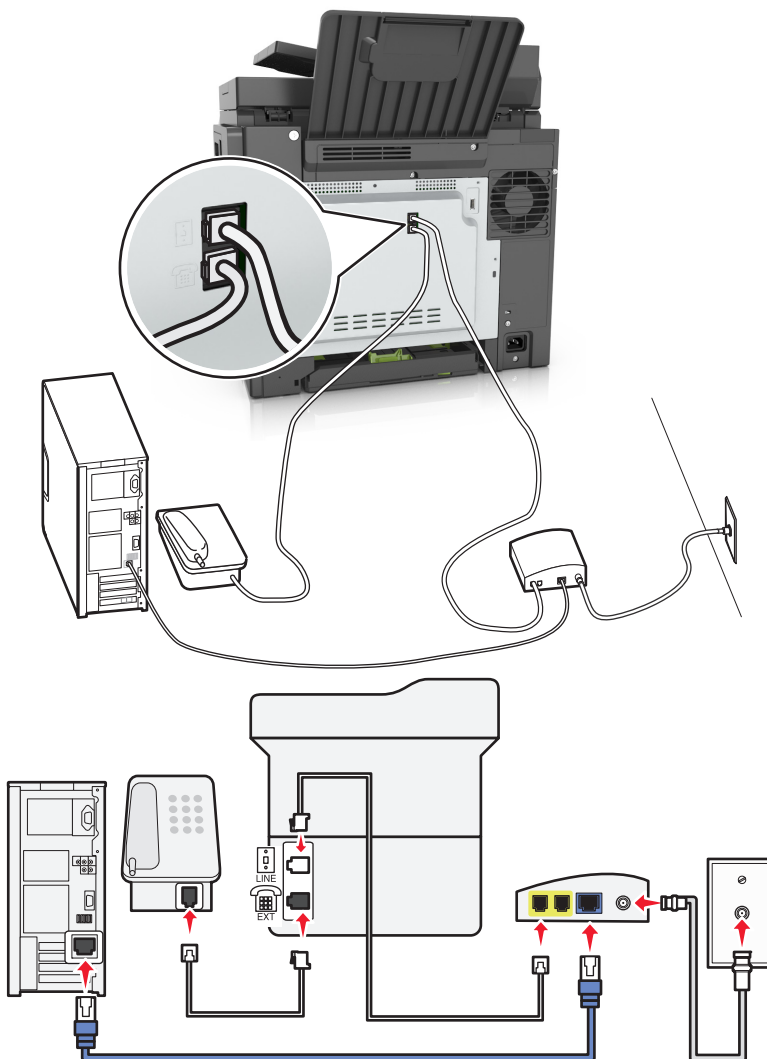

- 1 Connect one end of the telephone cable that came with your printer to the  port of the printer.
- 2 Connect the other end of the cable to the port labeled **Phone Line 1** or **Phone Port** on the cable modem.

**Note:** The port labeled **Phone Line 2** or **Fax Port** is not always active. VoIP providers may charge additional cost for activation of the second phone port.

- 3 Connect your analog telephone phone to the  port of the printer.



#### Notes:

- To make sure that the telephone port on the cable modem is active, plug an analog telephone into the telephone port, and then listen for a dial tone. If you hear a dial tone, then the port is active.
- If you need two telephone ports for your devices, but do not want to pay additional cost, then do not plug the printer into the second telephone port. You can use a phone splitter. Plug the phone splitter into the **Phone Line 1** or **Phone Port**, and then plug the printer and telephone into the splitter.

- Make sure you use a phone splitter, *not* a line splitter. To make sure that you are using the correct splitter, plug an analog telephone into the splitter and then listen for a dial tone.

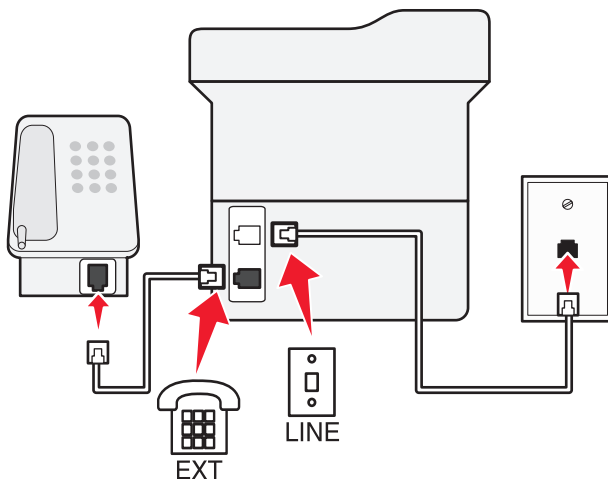
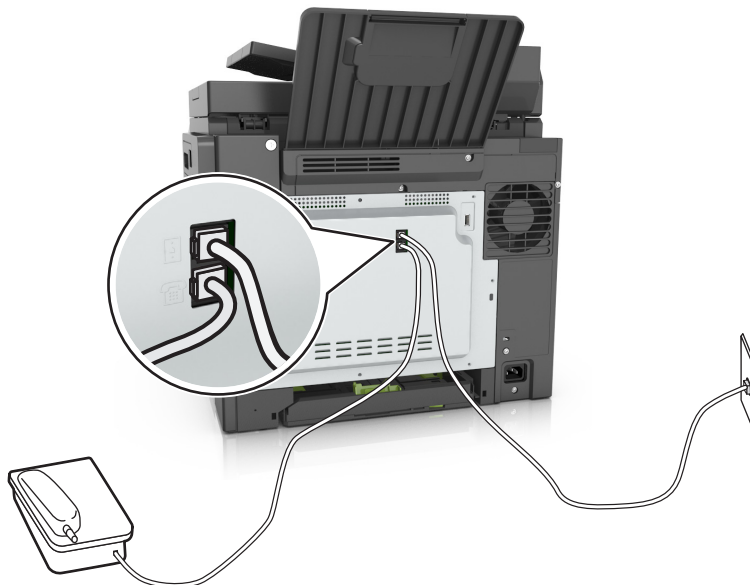
### Setup 2: Printer is connected to a wall jack; cable modem is installed elsewhere in the facility





- 1 Connect one end of the telephone cable that came with your printer to the  port of the printer.
- 2 Connect the other end of the telephone cable to an active analog telephone wall jack.
- 3 Connect your analog telephone to the  port of the printer.

### Scenario 5: Countries or regions with different telephone wall jacks and plugs

Some countries or regions may have different types of telephone wall jack connectors than those that came with the printer. The standard wall jack adopted by most countries or regions is RJ-11. Your printer comes with the RJ-11 jack and a telephone cable with the RJ-11 plug.

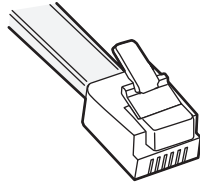
If the wall jack or equipment in your facility is not compatible with this type of connection, then you need to use a telephone adapter. An adapter for your country or region may not come with your printer, and you may need to purchase it separately.



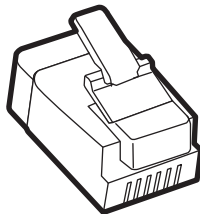

There may be an adapter plug installed in the  port of the printer. If you are using a telephone adapter or a facility that has a cascaded or serial wiring scheme, then do not remove the adapter plug from the  port of the printer.



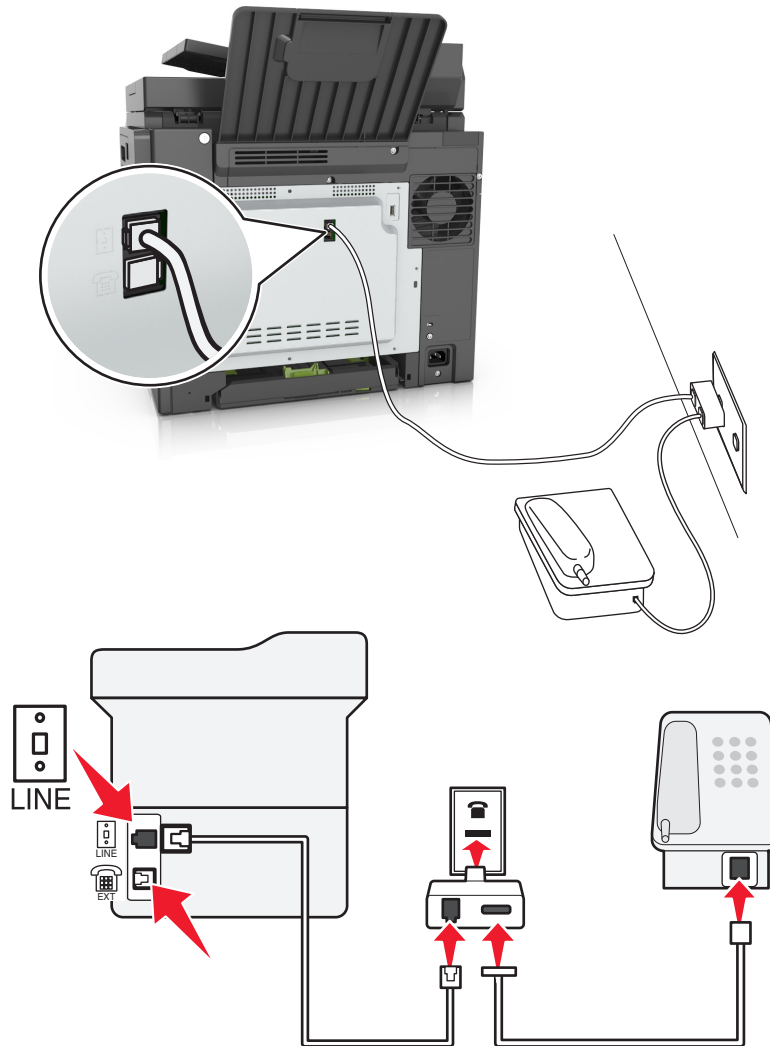

Part name	Part number
Lexmark adapter plug	40X8519

## Connecting the printer to a non-RJ-11 wall jack



- 1 Connect one end of the telephone cable that came with printer to the  port of the printer.
- 2 Connect the other end of the cable to the RJ-11 adapter, and then connect the adapter to the wall jack.
- 3 If you want to connect another device (telephone or answering machine) to the same wall jack, and if the device has a non-RJ-11 connector, then connect it directly to the telephone adapter.

### Notes:

- The  port of the printer may have an adapter plug for use with the adapter. Do *not* remove the plug from the  port of the printer.
- In some countries or regions, the printer may not come with a telephone adapter or an adapter plug.

### Connecting the printer to a wall jack in Germany

The German wall jack has two kinds of ports. The N ports are for fax machines, modems, and answering machines. The F port is for telephones.

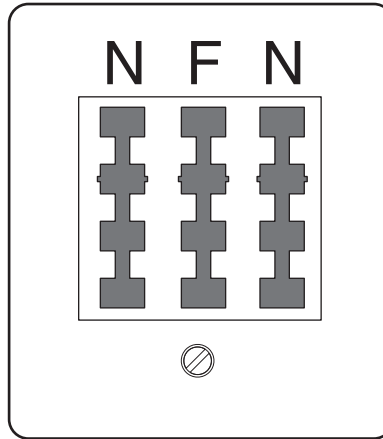

Connect the printer to any of the N ports.

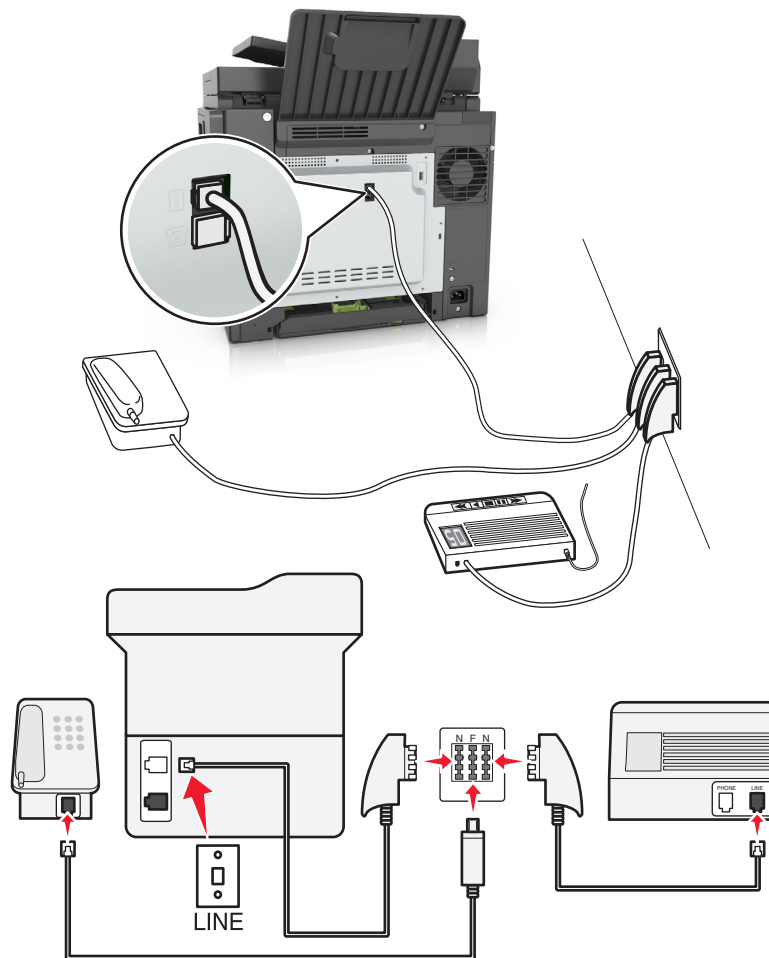

- 1 Connect one end of the telephone cable that came the printer to the  port of the printer.
- 2 Connect the other end of the telephone cable to the RJ-11 adapter, and then connect the adapter to an N port.

- 3 If you want to connect a telephone and answering machine to the same wall jack, then connect the devices as shown.

**Note:** Do *not* remove the adapter plug from the  port of the printer if you are connecting to a serial or cascaded telephone system.

## Connecting to a distinctive ring service

A distinctive ring service may be available from your telephone company. This service lets you have multiple telephone numbers on one telephone line, with each telephone number having a different ring pattern. This may be useful for distinguishing between fax and voice calls. If you subscribe to a distinctive ring service, then follow these steps to connect the equipment:

- 1 Connect one end of the telephone cable that came with the printer to the printer LINE port .
- 2 Connect the other end of the telephone cable to an active analog telephone wall jack.

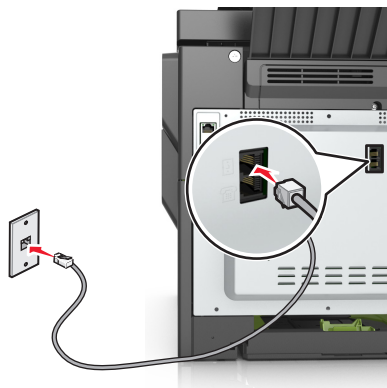

- 3 Change the distinctive rings setting to match the setting you want for the printer to answer.

**Note:** The factory default setting for distinctive rings is On. This sets the printer to answer single, double, and triple ring patterns.

- a From the home screen, navigate to:

 > **Settings** > **Fax Settings** > **Analog Fax Setup** > **Answer On**

- b Select the pattern setting you want to change, and then touch **Submit**.

## Setting the outgoing fax name and number

- 1 Open a Web browser, and then type the printer IP address in the address field.

### Notes:

- View the printer IP address on the printer home screen. The IP address appears as four sets of numbers separated by periods, such as 123.123.123.123.
- If you are using a proxy server, then temporarily disable it to load the Web page correctly.

- 2 Click **Settings** > **Fax Settings** > **Analog Fax Setup**.

- 3 In the Fax Name field, type the name to be printed on all outgoing faxes.

4 In the Fax Number field, enter the printer fax number.

5 Click **Submit**.

## Setting the date and time

You can set the date and time so that they are printed on every fax you send.

1 Open a Web browser, and then type the printer IP address in the address field.

### Notes:

- View the printer IP address on the printer home screen. The IP address appears as four sets of numbers separated by periods, such as 123.123.123.123.
- If you are using a proxy server, then temporarily disable it to load the Web page correctly.

2 Click **Security > Set Date and Time**.

3 In the Manually Set Date & Time field, enter the current date and time.

4 Click **Submit**.

**Note:** It is recommended to use the network time.

## Configuring the printer to observe daylight saving time

The printer can be set to automatically adjust for daylight saving time:

1 Open a Web browser, and then type the printer IP address in the address field.

### Notes:

- View the printer IP address on the printer home screen. The IP address appears as four sets of numbers separated by periods, such as 123.123.123.123.
- If you are using a proxy server, then temporarily disable it to load the Web page correctly.

2 Click **Security > Set Date and Time**.

3 Select the **Automatically Observe DST** check box, and then enter the DST start and end dates in the Custom Time Zone Setup section.

4 Click **Submit**.

## Sending a fax

### Sending a fax using the printer control panel

1 Load an original document faceup, short edge first into the ADF tray or facedown on the scanner glass.

### Notes:

- Do not load postcards, photos, small items, transparencies, photo paper, or thin media (such as magazine clippings) into the ADF tray. Place these items on the scanner glass.

- The ADF indicator light comes on when the paper is loaded properly.
- 2 If you are loading a document into the ADF tray, then adjust the paper guides.
  - 3 From the home screen, touch **Fax**.
  - 4 Enter the fax number or a shortcut.  
**Note:** To add recipients, touch **Next number**, and then enter the recipient's telephone number or shortcut number, or search the address book.
  - 5 Touch **Fax It**.

## Sending a fax using the computer

### For Windows users

- 1 With a document open, click **File > Print**.
- 2 Select the printer, and then click **Properties, Preferences, Options, or Setup**.
- 3 Click **Fax > Enable fax**, and then enter the recipient fax number or numbers.
- 4 If necessary, configure other fax settings.
- 5 Apply the changes, and then send the fax job.

### Notes:

- The fax option is available only with the PostScript driver or the Universal Fax Driver. For more information, go to <http://support.lexmark.com>.
- To use the fax option with the PostScript driver, configure and enable it in the Configuration tab.

### For Macintosh users

- 1 With a document open, choose **File > Print**.
- 2 Select the printer.
- 3 Enter the recipient fax number, and then configure other fax settings, if necessary.
- 4 Send the fax job.

## Sending a fax using a shortcut number

Fax shortcuts are like the speed dial numbers on a telephone or a fax machine. A shortcut number (1–999) can contain a single recipient or multiple recipients.

- 1 Load an original document faceup, short edge first into the ADF tray or facedown on the scanner glass.

### Notes:

- Do not load postcards, photos, small items, transparencies, photo paper, or thin media (such as magazine clippings) into the ADF tray. Place these items on the scanner glass.
  - The ADF indicator light comes on when the paper is loaded properly.
- 2 If you are loading a document into the ADF tray, then adjust the paper guides.



- 3 From the printer control panel, press #, and then enter the shortcut number using the keypad.
- 4 Touch **Fax It**.

## Sending a fax using the address book

The address book lets you search for bookmarks and network directory servers. For more information on enabling the address book feature, contact your system support person.

- 1 Load an original document faceup, short edge first into the ADF tray or facedown on the scanner glass.

### Notes:

- Do not load postcards, photos, small items, transparencies, photo paper, or thin media (such as magazine clippings) into the ADF tray. Place these items on the scanner glass.
- The ADF indicator light comes on when the paper is loaded properly.

- 2 If you are loading a document into the ADF tray, then adjust the paper guides.
- 3 From the home screen, navigate to:

**Fax** >  > type the name of the recipient > **Search**

**Note:** You can search only for one name at a time.

- 4 Touch the name of the recipient, and then touch **Fax It**.

## Sending a fax at a scheduled time

- 1 Load an original document faceup, short edge first into the ADF tray or facedown on the scanner glass.

### Notes:

- Do not load postcards, photos, small items, transparencies, photo paper, or thin media (such as magazine clippings) into the ADF tray. Place these items on the scanner glass.
- The ADF indicator light comes on when the paper is loaded properly.

- 2 If you are loading a document into the ADF tray, then adjust the paper guides.
- 3 From the home screen, navigate to:

**Fax** > enter the fax number > **Options** > **Delayed Send**

**Note:** If Fax Mode is set to Fax Server, then the Delayed Send button does not appear. Faxes waiting for transmission are listed in the fax queue.

- 4 Specify the time the fax will be transmitted, and then touch .

- 5 Touch **Fax It**.

**Note:** The document is scanned, and then faxed at the scheduled time.

## Creating shortcuts

### Creating a fax destination shortcut using the Embedded Web Server

Assign a shortcut number to a single fax number or a group of fax numbers.

- 1 Open a Web browser, and then type the printer IP address in the address field.

**Notes:**

- View the printer IP address on the printer home screen. The IP address appears as four sets of numbers separated by periods, such as 123.123.123.123.
- If you are using a proxy server, then temporarily disable it to load the Web page correctly.

- 2 Click **Settings > Manage Shortcuts > Fax Shortcut Setup**.

**Note:** A password may be required. If you do not have an ID and password, then contact your system support person.

- 3 Type a name for the shortcut, and then enter the fax number.

**Notes:**

- To create a multiple-number shortcut, enter the fax numbers for the group.
- Separate each fax number in the group with a semicolon (;).

- 4 Assign a shortcut number.

**Note:** If you enter a number that is already in use, then you are prompted to select another number.

- 5 Click **Add**.

### Creating a fax destination shortcut using the printer control panel

- 1 From the home screen, touch **Fax**, and then enter the fax number.

**Note:** To create a group of fax numbers, touch **Next number**, and then enter the next fax number.

- 2 Touch .

- 3 Type a unique name for the shortcut, and then touch **Done**.

- 4 Verify that the shortcut name and number are correct, and then touch **OK**.

**Note:** If the name or number is incorrect, then touch **Cancel**, and then reenter the information.

## Customizing fax settings

### Changing the fax resolution

- 1 Load an original document faceup, short edge first into the ADF tray or facedown on the scanner glass.

**Notes:**

- Do not load postcards, photos, small items, transparencies, photo paper, or thin media (such as magazine clippings) into the ADF tray. Place these items on the scanner glass.
- The ADF indicator light comes on when the paper is loaded properly.

**2** If you are loading a document into the ADF tray, then adjust the paper guides.

**3** From the home screen, navigate to:

**Fax** > enter the fax number > **Options**

**4** From the Resolution area, touch the arrows to select the resolution you want.

**Note:** Select a resolution from Standard (fastest speed) to Ultra Fine (best quality at a reduced speed).

**5** Touch **Fax It**.

## Making a fax lighter or darker

**1** Load an original document faceup, short edge first into the ADF tray or facedown on the scanner glass.

**Notes:**

- Do not load postcards, photos, small items, transparencies, photo paper, or thin media (such as magazine clippings) into the ADF tray. Place these items on the scanner glass.
- The ADF indicator light comes on when the paper is loaded properly.

**2** If you are loading a document into the ADF tray, then adjust the paper guides.

**3** From the home screen, navigate to:

**Fax** > enter the fax number > **Options**

**4** Adjust the fax darkness, and then touch **Fax It**.

## Viewing a fax log

**1** Open a Web browser, and then type the printer IP address in the address field.

**Notes:**

- View the printer IP address on the printer home screen. The IP address appears as four sets of numbers separated by periods, such as 123.123.123.123.
- If you are using a proxy server, then temporarily disable it to load the Web page correctly.

**2** Click **Settings** > **Reports**.

**3** Click **Fax Job Log** or **Fax Call Log**.

## Blocking junk faxes

**1** Open a Web browser, and then type the printer IP address in the address field.

**Notes:**

- View the printer IP address on the printer home screen. The IP address appears as four sets of numbers separated by periods, such as 123.123.123.123.

- If you are using a proxy server, then temporarily disable it to load the Web page correctly.

**2** Click **Settings > Fax Settings > Analog Fax Setup > Block No Name Fax**.

**Notes:**

- This option blocks all incoming faxes that have a private caller ID or have no fax name.
- In the Banned Fax List field, enter the phone numbers or type the fax names of specific fax callers you want to block.

## Canceling an outgoing fax

### Canceling a fax while the original documents are still scanning

- When using the ADF, touch **Cancel Job** on the printer control panel while **Scanning** appears.
- When using the scanner glass, touch **Cancel Job** on the printer control panel while **Scanning** appears or while **Scan the Next Page** and **Finish the Job** appear.

### Canceling a fax after the original documents have been scanned to memory

**1** On the home screen, touch **Cancel Jobs**.

The Cancel Jobs screen appears.

**2** Touch the job or jobs you want to cancel.

Only three jobs appear on the screen; touch the down arrow until the job you want appears, and then touch the job you want to cancel.

**3** Touch **Delete Selected Jobs**.

The Deleting Selected Jobs screen appears, the selected jobs are deleted, and then the home screen appears.

## Holding and forwarding faxes

### Holding faxes

This option lets you hold received faxes from printing until they are released. Held faxes can be released manually or at a scheduled day or time.

**1** Open a Web browser, and then type the printer IP address in the address field.

**Notes:**

- View the printer IP address on the printer home screen. The IP address appears as four sets of numbers separated by periods, such as 123.123.123.123.
- If you are using a proxy server, then temporarily disable it to load the Web page correctly.

**2** Click **Settings > Fax Settings > Analog Fax Setup > Holding Faxes**.

- 3 From the Held Fax Mode menu, select one of the following:
  - **Off**
  - **Always On**
  - **Manual**
  - **Scheduled**
- 4 If you selected Scheduled, then continue with the following steps:
  - a Click **Fax Holding Schedule**.
  - b From the Action menu, select **Hold faxes**.
  - c From the Time menu, select the time you want the held faxes released.
  - d From the Day(s) menu, select the day you want the held faxes released.
- 5 Click **Add**.

## Forwarding a fax

This option lets you print and forward received faxes to a fax number, e-mail address, FTP site, or LDSS.

- 1 Open a Web browser, and then type the printer IP address in the address field.

### Notes:

- View the printer IP address on the printer home screen. The IP address appears as four sets of numbers separated by periods, such as 123.123.123.123.
- If you are using a proxy server, then temporarily disable it to load the Web page correctly.

- 2 Click **Settings > Fax Settings**.
- 3 From the Fax Forwarding menu, select **Print**, **Print and Forward**, or **Forward**.
- 4 From the “Forward to” menu, select **Fax**, **E-mail**, **FTP**, **LDSS**, or **eSF**.
- 5 In the “Forward to Shortcut” field, enter the shortcut number where you want the fax forwarded.  
**Note:** The shortcut number must be valid for the setting selected in the “Forward to” menu.
- 6 Click **Submit**.

## Understanding the fax options

### Resolution

This option lets you adjust the quality of the fax output. Increasing the image resolution increases the file size and the time needed to scan your original document. Decreasing the image resolution reduces the file size.

Select from the following values:

- **Standard**—Use this when faxing most documents.
- **Fine 200 dpi**—Use this when faxing documents with small prints.
- **Super Fine 300 dpi**—Use this when faxing documents with fine details.

## Darkness

This option lets you adjust how light or dark the faxes are in relation to the original document.

## Page Setup

This option lets you change the following settings:

- **Sides (Duplex)**—This specifies if the original document is printed on one side or on both sides of the page (duplex). This also identifies what needs to be scanned for inclusion in the fax.
- **Orientation**—This specifies the orientation of the original document, and then changes the Sides (Duplex) and Binding settings to match the orientation.
- **Binding**—This specifies if the original document is bound on the long-edge or short-edge side.

## Content

This option lets you specify the content type and source of the original document.

Select from the following content types:

- **Graphics**—The original document is mostly business-type graphics, such as pie charts, bar charts, and animations.
- **Photo**—The original document is mostly a photo or an image.
- **Text**—The content of the original document is mostly text or line art.
- **Text/Photo**—The original document is a mixture of text, graphics, and photos.

Select from the following content sources:

- **Black/White Laser**—The original document was printed using a mono laser printer.
- **Color Laser**—The original document was printed using a color laser printer.
- **Inkjet**—The original document was printed using an inkjet printer.
- **Magazine**—The original document is from a magazine.
- **Newspaper**—The original document is from a newspaper.
- **Other**—The original document was printed using an alternate or unknown printer.
- **Photo/Film**—The original document is a photo from film.
- **Press**—The original document was printed using a printing press.

## Color

This option lets you set the output to either color or monochrome for the scanned image.

## Delayed Send

This option lets you send a fax at a later time or date.

## Scan Preview

This option lets you view the first page of the image before it is included in the fax. When the first page is scanned, the scanning is paused and a preview image appears.

**Note:** This option appears only when a working printer hard disk is installed.

## Using the advanced options

Select from the following settings:

- **Adjust ADF Skew**—This option lets you straighten scanned images that are slightly skewed when received from the ADF tray.
- **Advanced Imaging**—This adjusts the Background Removal, Color Balance, Color Dropout, Contrast, Mirror Image, Negative Image, Scan Edge to Edge, Shadow Detail, Sharpness, and Temperature settings before you fax the document.
- **Custom Job**—This combines multiple scanning jobs into a single job.

**Note:** This option appears only when a formatted, working printer hard disk is installed.



- **Edge Erase**—This removes smudges or marks around the edges of a document. You can choose to remove an equal area around all four sides of the paper, or pick a particular edge. Edge Erase erases whatever is within the area selected, leaving nothing on that portion of the scan.
- **Transmission Log**—This prints the transmission log or transmission error log.

# Scanning

## Using Scan to Network

Scan to Network lets you scan your documents to network destinations specified by your system support person. After the destinations (shared network folders) have been established on the network, the setup process for the application involves installing and configuring the application on the appropriate printer using its Embedded Web Server. For more information, see [“Setting up Scan to Network” on page 23](#).

## Scanning to an FTP address

Automatic document feeder (ADF)	Scanner glass
	
<p>Use the ADF for multiple-page documents including two-sided pages.</p>	<p>Use the scanner glass for single-page documents, book pages, small items (such as postcards or photos), transparencies, photo paper, or thin media (such as magazine clippings).</p>

The scanner lets you scan documents directly to a File Transfer Protocol (FTP) server. Only one FTP address may be sent to the server at a time.

When an FTP destination has been configured by your system support person, the name of the destination becomes available as a shortcut number, or it is listed as a profile under the Held Jobs icon. An FTP destination could also be another PostScript printer.

## Creating shortcuts

Instead of entering the entire FTP site address on the printer control panel each time you want to send a document to an FTP server, you can create a permanent FTP destination and assign a shortcut number. There are two methods for creating shortcut numbers: using the Embedded Web Server and using the printer control panel.

### Creating an FTP shortcut using the Embedded Web Server

- 1 Open a Web browser, and then type the printer IP address in the address field.



**Notes:**

- View the printer IP address on the printer home screen. The IP address appears as four sets of numbers separated by periods, such as 123.123.123.123.
- If you are using a proxy server, then temporarily disable it to load the Web page correctly.

2 Navigate to:

**Settings** > Other Settings area > **Manage Shortcuts** > **FTP Shortcut Setup**

3 Enter the appropriate information.

**Note:** A password may be required. If you do not have an ID and password, then contact your system support person.

4 Enter a shortcut number.

**Note:** If you enter a number that is already in use, then you are prompted to select another number.

5 Click **Add**.

## Creating an FTP shortcut using the printer control panel

1 From the home screen, navigate to:

**FTP** > **FTP** > type the FTP address >  > type a name for the shortcut > **Done**

2 Verify that the shortcut name and number are correct, and then touch **OK**.

**Notes:**

- If the name or number is incorrect, then touch **Cancel**, and then reenter the information.
- If you enter a number that is already in use, then you are prompted to select another number.

## Scanning to an FTP address

### Scanning to an FTP address using the printer control panel

1 Load an original document faceup, short edge first into the ADF tray or facedown on the scanner glass.

**Notes:**

- Do not load postcards, photos, small items, transparencies, photo paper, or thin media (such as magazine clippings) into the ADF tray. Place these items on the scanner glass.
- The ADF indicator light comes on when the paper is loaded properly.

2 If you are loading a document into the ADF tray, then adjust the paper guides.

3 From the printer control panel, navigate to:

**FTP** > **FTP** > type the FTP address > **Done** > **Send It**

### Scanning to an FTP address using a shortcut number

1 Load an original document faceup, short edge first into the ADF tray or facedown on the scanner glass.

**Notes:**

- Do not load postcards, photos, small items, transparencies, photo paper, or thin media (such as magazine clippings) into the ADF tray. Place these items on the scanner glass.
- The ADF indicator light comes on when the paper is loaded properly.

**2** If you are loading a document into the ADF tray, then adjust the paper guides.

**3** From the printer control panel, press # on the keypad, and then enter the FTP shortcut number.

**4** Touch  > **Send It.**

**Scanning an FTP using the address book**

**1** Load an original document faceup, short edge first into the ADF tray or facedown on the scanner glass.

**Notes:**

- Do not load postcards, photos, small items, transparencies, photo paper, or thin media (such as magazine clippings) into the ADF tray. Place these items on the scanner glass.
- The ADF indicator light comes on when the paper is loaded properly.

**2** If you are loading a document into the ADF tray, then adjust the paper guides.

**3** From the home screen, navigate to:

**FTP > FTP >  > type the name of the recipient > Search**

**4** Touch the name of the recipient.

**Note:** To search for additional recipients, touch **New Search**, and then type the name of the next recipient.

**5** Touch  > **Send It.**

**Scanning to a computer or flash drive**

Automatic document feeder (ADF)	Scanner glass
	

Automatic document feeder (ADF)	Scanner glass
Use the ADF for multiple-page documents.	Use the scanner glass for single-page documents, small items (such as postcards or photos), transparencies, photo paper, or thin media (such as magazine clippings).

The scanner lets you scan documents directly to a computer or a flash drive. The computer does not have to be directly connected to the printer for you to receive images using Scan to Computer. You can scan the document back to the computer over the network by creating a scan profile on the computer and then downloading the profile to the printer.

## Scanning to a computer using the Embedded Web Server

- 1 Open a Web browser, and then type the printer IP address in the address field.

### Notes:

- View the printer IP address on the printer home screen. The IP address appears as four sets of numbers separated by periods, such as 123.123.123.123.
- If you are using a proxy server, then temporarily disable it to load the Web page correctly.

- 2 Click **Scan Profile** > **Create Scan Profile**.

- 3 Select your scan settings, and then click **Next**.

- 4 Select a location on your computer where you want to save the scan image.

- 5 Type a scan name, and then a user name.

**Note:** The scan name is the name that appears in the Scan Profile list on the display.

- 6 Click **Submit**.

**Note:** Clicking **Submit** automatically assigns a shortcut number. You can use this shortcut number when you are ready to scan your documents.

- 7 Review the instructions on the Scan Profile screen.

- a Load an original document faceup, short edge first into the ADF tray or facedown on the scanner glass.

### Notes:

- Do not load postcards, photos, small items, transparencies, photo paper, or thin media (such as magazine clippings) into the ADF tray. Place these items on the scanner glass.
- The ADF indicator light comes on when the paper is loaded properly.

- b If you are loading a document into the ADF tray, then adjust the paper guides.

- c Do either of the following:

- Press #, and then enter the shortcut number using the keypad.
- From the home screen, navigate to:  
**Held Jobs** > **Profiles** > select your shortcut on the list

**Note:** The scanner scans and sends the document to the directory you specified.

- 8 View the file from the computer.

**Note:** The output file is saved in the location or launched in the program you specified.

## Setting up Scan to Computer

### Notes:

- This feature is supported only in Windows Vista or later.
- Make sure your computer and printer are connected to the same network.

1 Open the printers folder, and then select your printer.

**Note:** If your printer is not in the list, then add your printer.

2 Open the printer properties, and then adjust the settings as necessary.

3 From the control panel, touch **Scan to Computer** > select the appropriate scan setting > **Send It**.

## Scanning to a flash drive

1 Load an original document faceup, short edge first into the ADF tray or facedown on the scanner glass.

### Notes:

- Do not load postcards, photos, small items, transparencies, photo paper, or thin media (such as magazine clippings) into the ADF tray. Place these items on the scanner glass.
- The ADF indicator light comes on when the paper is loaded properly.

2 If you are loading a document into the ADF tray, then adjust the paper guides.

3 Insert the flash drive into the USB port on the front of the printer.

**Note:** The USB Drive home screen appears.

4 Select the destination folder, and then touch **Scan to USB drive**.

**Note:** The printer goes back to the home screen after 30 seconds of inactivity.

5 Adjust the scan settings, and then touch **Scan It**.

## Understanding the scan options

### FTP

This option lets you enter the IP address for the FTP destination.

**Note:** An IP address appears as four sets of numbers separated by periods, such as 123.123.123.123.

### File Name

This option lets you type a file name for the scan image.

### Original Size

This option lets you set the paper size of the documents you are going to scan. When Original Size is set to Mixed Sizes, you can scan an original document that contains mixed paper sizes (letter- and legal-size pages).

## Resolution

This option lets you adjust the output quality of your file. Increasing the image resolution increases the file size and the time needed to scan your original document. Decreasing the image resolution reduces the file size.

## Color

This option lets you set the output to either color or monochrome for the scanned image.

## Content

This option lets you set the original document type and source.

Select from the following content types:

- **Graphics**—The original document is mostly business-type graphics, such as pie charts, bar charts, and animations.
- **Photo**—The original document is mostly a photo or an image.
- **Text**—The content of the original document is mostly text or line art.
- **Text/Photo**—The original document is a mixture of text, graphics, and photos.

Select from the following content sources:

- **Black/White Laser**—The original document was printed using a mono laser printer.
- **Color Laser**—The original document was printed using a color laser printer.
- **Inkjet**—The original document was printed using an inkjet printer.
- **Magazine**—The original document is from a magazine.
- **Newspaper**—The original document is from a newspaper.
- **Other**—The original document was printed using an alternate or unknown printer.
- **Photo/Film**—The original document is a photo from film.
- **Press**—The original document was printed using a printing press.

## Darkness

This option lets you adjust how light or dark the scanned documents are in relation to the original document.

## Send As

This option lets you set the output type for the scan image.

Select one of the following:

- **PDF**—Use to create a single file with multiple pages. The PDF can be sent as a secured or compressed file.
- **TIFF**—Use to create multiple files or a single file. If Multi-page TIFF is turned off in the Settings menu, then TIFF saves one page in each file. The file size is usually larger than an equivalent JPEG.
- **JPEG**—Use to create and attach a separate file for each page of the original document.
- **XPS**—Use to create a single XPS file with multiple pages.
- **RTF**—Use to create a file in editable format.
- **TXT**—Use to create ASCII text file with no formatting.

## Page Setup

This option lets you change the following settings:

- **Sides (Duplex)**—This specifies if the original document is printed on only one side or on both sides of the paper.
- **Orientation**—This specifies the orientation of the original document, and then changes the Sides (Duplex) and Binding settings to match the orientation.
- **Binding**—This specifies if the original document is bound on the long-edge or short-edge side.

## Scan Preview

This option lets you view the first page of the image before it is included in the file. When the first page is scanned, the scanning is paused and a preview image appears.

**Note:** This option appears only when a formatted, working printer hard disk is installed.

## Save As Shortcut

This option lets you save the current settings as a shortcut by assigning a shortcut name.

**Note:** Selecting this option automatically assigns the next available shortcut number.

## Using the advanced options

Select from the following settings:

- **Adjust ADF Skew**—This straightens scanned images that are slightly skewed when received from the ADF tray.
- **Advanced Imaging**—This adjusts the Background Removal, Color Balance, Color Dropout, Contrast, JPEG Quality, Mirror Image, Negative Image, Scan Edge to Edge, Shadow Detail, Sharpness, and Temperature settings before you scan the document.
- **Custom Job**—This combines multiple scanning jobs into a single job.

**Note:** This option appears only when a formatted, working printer hard disk is installed.

- **Edge Erase**—This removes smudges or marks around the edges of a document. You can choose to remove an equal area around all four sides of the paper, or pick a particular edge. Edge Erase erases whatever is within the area selected, leaving nothing on that portion of the scan.
- **Transmission Log**—This prints the transmission log or transmission error log.

# Understanding the printer menus

## Menus list

<b>Supplies Menu</b>	<b>Paper Menu</b>	<b>Reports</b>	<b>Network/Ports</b>	<b>Security</b>
Cyan Cartridge	Default Source	Menu Settings Page	Active NIC	Edit Security Setups
Magenta Cartridge	Paper Size/Type	Device Statistics	Standard Network <sup>1</sup>	Miscellaneous Security Settings
Yellow Cartridge	Substitute Size	Network Setup Page	Standard USB	Confidential Print
Black Cartridge	Paper Texture	Network [x] Setup Page	SMTP Setup	Erase Temporary Data Files
Waste Toner Bottle	Paper Weight	Shortcut List		Security Audit Log
Imaging Kit	Paper Loading	Fax Job Log		Set Date and Time
Maintenance Kit	Custom Types	Fax Call Log		
	Custom Names	Copy Shortcuts		
	Custom Scan Sizes	E-mail Shortcuts		
	Universal Setup	Fax Shortcuts		
		FTP Shortcuts		
		Profiles List		
		Print Fonts		
		Print Directory		
		Print Demo		
		Asset Report		
		Event Log Summary		
<b>Settings</b>	<b>Help</b>	<b>Manage Shortcuts</b>	<b>Option Card Menu<sup>2</sup></b>	
General Settings	Print All Guides	Fax Shortcuts	[index of each installed DLE]	
Copy Settings	Copy Guide	E-mail Shortcuts		
Fax Settings	E-mail Guide	FTP Shortcuts		
E-mail Settings	Fax Guide	Copy Shortcuts		
FTP Settings	FTP Guide	Profile Shortcuts		
Flash Drive Menu	Color Quality			
OCR Settings	Print Defects Guide			
Print Settings	Information Guide			
	Supplies Guide			

<sup>1</sup> Depending on the printer setup, this menu item appears as Standard Network or Network [x].

<sup>2</sup> This menu appears only when one or more DLEs are installed.

## Supplies menu

Use	To
<b>Cyan Cartridge</b>	View the status of the toner cartridges, which can be any of the following: Early Warning Low Invalid Near End of Life Replace Missing Defective OK Unsupported
<b>Magenta Cartridge</b>	
<b>Yellow Cartridge</b>	
<b>Black Cartridge</b>	
<b>Waste Toner Bottle</b> Near Full Replace Missing OK	View the status of the waste toner bottle.
<b>Imaging Kit</b> OK Replace Black Imaging Kit Replace Color Imaging Kit	View the status of the imaging kit.
<b>Maintenance Kit</b> OK Replace	View the status of the maintenance kit.

## Paper menu

### Default Source menu

Use	To
<b>Default Source</b> Tray [x] Multipurpose Feeder Manual Paper Manual Envelope	Set a default paper source for all print jobs.  <b>Notes:</b> <ul style="list-style-type: none"> <li>• The 650-sheet duo tray must be installed in order for Multipurpose Feeder to appear as a menu setting in the Paper menu.</li> <li>• Tray 1 (standard tray) is the factory default setting.</li> <li>• Only installed paper sources will appear as menu settings.</li> <li>• If two trays contain paper of the same size and type, and the trays have the same settings, then the trays are automatically linked. When one tray is empty, the print job continues using the linked tray.</li> </ul>



## Paper Size/Type menu

Use	To
<p><b>Tray [x] Size</b></p> <ul style="list-style-type: none"> <li>A4</li> <li>A5</li> <li>JIS-B5</li> <li>Letter</li> <li>Legal</li> <li>Executive</li> <li>Oficio (Mexico)</li> <li>Folio</li> <li>Universal</li> </ul>	<p>Specify the paper size loaded in each tray.</p> <p><b>Notes:</b></p> <ul style="list-style-type: none"> <li>• Letter is the U.S. factory default setting. A4 is the international factory default setting.</li> <li>• If two trays contain paper of the same size and type, and the trays have the same settings, then the trays are automatically linked. When one tray is empty, the print job continues using the linked tray.</li> </ul>
<p><b>Tray [x] Type</b></p> <ul style="list-style-type: none"> <li>Plain Paper</li> <li>Card Stock</li> <li>Transparency</li> <li>Recycled</li> <li>Labels</li> <li>Glossy</li> <li>Bond</li> <li>Letterhead</li> <li>Preprinted</li> <li>Colored Paper</li> <li>Light Paper</li> <li>Heavy Paper</li> <li>Rough/Cotton</li> <li>Custom Type [x]</li> </ul>	<p>Specify the type of paper loaded in each tray.</p> <p><b>Notes:</b></p> <ul style="list-style-type: none"> <li>• Plain Paper is the factory default setting for Tray 1. Custom Type [x] is the factory default setting for all other trays.</li> <li>• If available, a user-defined name appears instead of Custom Type [x].</li> <li>• Use this menu to configure automatic tray linking.</li> <li>• Transparency is supported only in the 250-sheet tray.</li> </ul>
<p><b>Note:</b> Only installed trays and feeders are listed in this menu.</p>	

Use	To
<p><b>MP Feeder Size</b></p> <ul style="list-style-type: none"> <li>A4</li> <li>A5</li> <li>A6</li> <li>JIS B5</li> <li>Letter</li> <li>Legal</li> <li>Executive</li> <li>Oficio (Mexico)</li> <li>Folio</li> <li>Statement</li> <li>Universal</li> <li>7 3/4 Envelope</li> <li>9 Envelope</li> <li>10 Envelope</li> <li>DL Envelope</li> <li>C5 Envelope</li> <li>B5 Envelope</li> <li>Other Envelope</li> </ul>	<p>Specify the paper size loaded in the multipurpose feeder.</p> <p><b>Notes:</b></p> <ul style="list-style-type: none"> <li>• Letter is the U.S. factory default setting. A4 is the international factory default setting.</li> <li>• The menu item applies only when the multipurpose feeder (MP Feeder) is installed.</li> <li>• The multipurpose feeder does not automatically detect paper size. The paper size value must be set.</li> </ul>
<p><b>MP Feeder Type</b></p> <ul style="list-style-type: none"> <li>Plain Paper</li> <li>Card Stock</li> <li>Transparency</li> <li>Recycled</li> <li>Glossy</li> <li>Labels</li> <li>Bond</li> <li>Envelope</li> <li>Letterhead</li> <li>Preprinted</li> <li>Colored Paper</li> <li>Light Paper</li> <li>Heavy Paper</li> <li>Rough/Cotton</li> <li>Custom Type [x]</li> </ul>	<p>Specify the paper type loaded in the multipurpose feeder.</p> <p><b>Note:</b> Custom Type [x] is the factory default setting.</p>
<p><b>Note:</b> Only installed trays and feeders are listed in this menu.</p>	

Use	To
<p><b>Manual Paper Size</b></p> <ul style="list-style-type: none"> <li>A4</li> <li>A5</li> <li>A6</li> <li>JIS B5</li> <li>Letter</li> <li>Legal</li> <li>Executive</li> <li>Oficio (Mexico)</li> <li>Folio</li> <li>Statement</li> <li>Universal</li> </ul>	<p>Specify the size of the paper being manually loaded.</p> <p><b>Note:</b> Letter is the U.S. factory default setting. A4 is the international factory default setting.</p>
<p><b>Manual Paper Type</b></p> <ul style="list-style-type: none"> <li>Plain Paper</li> <li>Card Stock</li> <li>Transparency</li> <li>Recycled</li> <li>Glossy</li> <li>Labels</li> <li>Bond</li> <li>Letterhead</li> <li>Preprinted</li> <li>Colored Paper</li> <li>Light Paper</li> <li>Heavy Paper</li> <li>Rough/Cotton</li> <li>Custom Type [x]</li> </ul>	<p>Specify the paper type being manually loaded.</p> <p><b>Note:</b> Plain Paper is the factory default setting.</p>
<p><b>Manual Envelope Size</b></p> <ul style="list-style-type: none"> <li>7 3/4 Envelope</li> <li>9 Envelope</li> <li>10 Envelope</li> <li>DL Envelope</li> <li>C5 Envelope</li> <li>B5 Envelope</li> <li>Other Envelope</li> </ul>	<p>Specify the envelope size being manually loaded.</p> <p><b>Note:</b> 10 Envelope is the U.S. factory default setting. DL Envelope is the international factory default setting.</p>
<p><b>Manual Envelope Type</b></p> <ul style="list-style-type: none"> <li>Envelope</li> <li>Custom Type [x]</li> </ul>	<p>Specify the envelope type being manually loaded.</p> <p><b>Note:</b> Envelope is the factory default setting.</p>
<p><b>Note:</b> Only installed trays and feeders are listed in this menu.</p>	

## Substitute Size menu

Use	To
<b>Substitute Size</b> Off Statement/A5 Letter/A4 All Listed	Substitute a specified paper size if the requested paper size is not available.  <b>Notes:</b> <ul style="list-style-type: none"> <li>• All Listed is the factory default setting. All available substitutions are allowed.</li> <li>• Off indicates that no size substitutions are allowed.</li> <li>• Setting a size substitution lets the print job continue without <b>Change Paper</b> appearing.</li> </ul>

## Paper Texture menu

Use	To
<b>Plain Texture</b> Smooth Normal Rough	Specify the relative texture of the plain paper loaded. <b>Note:</b> Normal is the factory default setting.
<b>Card Stock Texture</b> Smooth Normal Rough	Specify the relative texture of the card stock loaded. <b>Notes:</b> <ul style="list-style-type: none"> <li>• Normal is the factory default setting.</li> <li>• The options appear only if card stock is supported.</li> </ul>
<b>Transparency Texture</b> Smooth Normal Rough	Specify the relative texture of the transparencies loaded. <b>Note:</b> Normal is the factory default setting.
<b>Recycled Texture</b> Smooth Normal Rough	Specify the relative texture of the recycled paper loaded. <b>Note:</b> Normal is the factory default setting.
<b>Glossy Texture</b> Smooth Normal Rough	Specify the relative texture of the glossy paper loaded. <b>Note:</b> Normal is the factory default setting.
<b>Labels Texture</b> Smooth Normal Rough	Specify the relative texture of the labels loaded. <b>Note:</b> Normal is the factory default setting.
<b>Bond Texture</b> Smooth Normal Rough	Specify the relative texture of the bond paper loaded. <b>Note:</b> Rough is the factory default setting.

Use	To
<b>Envelope Texture</b> Smooth Normal Rough	Specify the relative texture of the envelopes loaded. <b>Note:</b> Normal is the factory default setting.
<b>Letterhead Texture</b> Smooth Normal Rough	Specify the relative texture of the letterhead loaded. <b>Note:</b> Normal is the factory default setting.
<b>Preprinted Texture</b> Smooth Normal Rough	Specify the relative texture of the preprinted paper loaded. <b>Note:</b> Normal is the factory default setting.
<b>Colored Texture</b> Smooth Normal Rough	Specify the relative texture of the colored paper loaded. <b>Note:</b> Normal is the factory default setting.
<b>Light Texture</b> Smooth Normal Rough	Specify the relative texture of the light paper loaded. <b>Note:</b> Normal is the factory default setting.
<b>Heavy Texture</b> Smooth Normal Rough	Specify the relative texture of the heavy paper loaded. <b>Note:</b> Normal is the factory default setting.
<b>Rough/Cotton Texture</b> Rough	Specify the relative texture of the cotton paper loaded.
<b>Custom [x] Texture</b> Smooth Normal Rough	Specify the relative texture of the custom paper loaded. <b>Notes:</b> <ul style="list-style-type: none"> <li>• Normal is the factory default setting.</li> <li>• The options appear only if custom type is supported.</li> </ul>

## Paper Weight menu

Use	To
<b>Plain Weight</b> Light Normal Heavy	Specify the relative weight of the plain paper loaded. <b>Note:</b> Normal is the factory default setting.

Use	To
<b>Card Stock Weight</b> Light Normal Heavy	Specify the relative weight of the card stock loaded. <b>Note:</b> Normal is the factory default setting.
<b>Transparency Weight</b> Light Normal Heavy	Specify the relative weight of the transparencies loaded. <b>Note:</b> Normal is the factory default setting.
<b>Recycled Weight</b> Light Normal Heavy	Specify the relative weight of the recycled paper loaded. <b>Note:</b> Normal is the factory default setting.
<b>Glossy Weight</b> Light Normal Heavy	Specify the relative weight of the glossy paper loaded. <b>Note:</b> Normal is the factory default setting.
<b>Labels Weight</b> Light Normal Heavy	Specify the relative weight of the labels loaded. <b>Note:</b> Normal is the factory default setting.
<b>Bond Weight</b> Light Normal Heavy	Specify the relative weight of the bond paper loaded. <b>Note:</b> Normal is the factory default setting.
<b>Envelope Weight</b> Light Normal Heavy	Specify the relative weight of the envelope loaded. <b>Note:</b> Normal is the factory default setting.
<b>Letterhead Weight</b> Light Normal Heavy	Specify the relative weight of the letterhead loaded. <b>Note:</b> Normal is the factory default setting.
<b>Preprinted Weight</b> Light Normal Heavy	Specify the relative weight of the preprinted paper loaded. <b>Note:</b> Normal is the factory default setting.
<b>Colored Weight</b> Light Normal Heavy	Specify the relative weight of the colored paper loaded. <b>Note:</b> Normal is the factory default setting.
<b>Light Weight</b> Light	Specify that the relative weight of the paper loaded is light.

Use	To
<b>Heavy Weight</b> Heavy	Specify that the relative weight of the paper loaded is heavy.
<b>Rough/Cotton Weight</b> Light Normal Heavy	Specify the relative weight of the rough or cotton paper loaded. <b>Note:</b> Normal is the factory default setting.
<b>Custom [x] Weight</b> Light Normal Heavy	Specify the relative weight of the custom paper loaded. <b>Notes:</b> <ul style="list-style-type: none"> <li>• Normal is the factory default setting.</li> <li>• The options appear only when the custom type is supported.</li> </ul>

## Paper Loading menu

Use	To
<b>Recycled Loading</b> Duplex Off	Determine and set two-sided printing for all print jobs that specify Recycled as the paper type.
<b>Glossy Loading</b> Duplex Off	Determine and set two-sided printing for all print jobs that specify Glossy as the paper type.
<b>Bond Loading</b> Duplex Off	Determine and set two-sided printing for all print jobs that specify Bond as the paper type.
<b>Letterhead Loading</b> Duplex Off	Determine and set two-sided printing for all print jobs that specify Letterhead as the paper type.
<b>Preprinted Loading</b> Duplex Off	Determine and set two-sided printing for all print jobs that specify Preprinted as the paper type.
<b>Colored Loading</b> Duplex Off	Determine and set two-sided printing for all print jobs that specify Colored as the paper type.
<b>Light Loading</b> Duplex Off	Determine and set two-sided printing for all print jobs that specify Light as the paper type.
<b>Notes:</b> <ul style="list-style-type: none"> <li>• Duplex sets the printer default to two-sided printing for every print job unless one-sided printing is selected from Printing Preferences or the Print dialog.</li> <li>• Off is the factory default setting for all the menus.</li> </ul>	

Use	To
<b>Heavy Loading</b> Duplex Off	Determine and set two-sided printing for all print jobs that specify Heavy as the paper type.
<b>Custom [x] Loading</b> Duplex Off	Determine and set two-sided printing for all print jobs that specify Custom [x] as the paper type.  <b>Note:</b> Custom [x] Loading is available only when the custom type is supported.
<b>Notes:</b> <ul style="list-style-type: none"> <li>• Duplex sets the printer default to two-sided printing for every print job unless one-sided printing is selected from Printing Preferences or the Print dialog.</li> <li>• Off is the factory default setting for all the menus.</li> </ul>	

## Custom Types menu

Use	To
<b>Custom Type [x]</b> Paper Card Stock Transparency Glossy Rough/Cotton Labels Envelope	Associate a paper or specialty media type with a factory default Custom Type [x] name or a user-defined custom name created in the Embedded Web Server or MarkVision™ Professional.  <b>Notes:</b> <ul style="list-style-type: none"> <li>• Paper is the factory default setting for Custom Type [x].</li> <li>• The custom media type must be supported in the selected tray or feeder in order to print from that source.</li> </ul>
<b>Recycled</b> Paper Card Stock Transparency Glossy Rough/Cotton Labels Envelope	Specify a paper type when Recycled is selected.  <b>Notes:</b> <ul style="list-style-type: none"> <li>• Paper is the factory default setting.</li> <li>• The Recycled paper type must be supported in the selected tray or feeder in order to print from that source.</li> </ul>

## Custom Names menu

Use	To
<b>Custom Name [x]</b>	Specify a custom name for a paper type. This name replaces Custom Type [x] in the printer menus.



## Custom Scan Sizes menu

Use	To
<b>Custom Scan Size [x]</b> Scan Size Name Width Height Orientation 2 scans per side Off On	Specify a custom scan size name, size, and page orientation.  <b>Notes:</b> <ul style="list-style-type: none"> <li>• 8.5 inches is the U.S. factory default setting for Width. 216 mm is the international factory default setting for Width.</li> <li>• 14 inches is the U.S. factory default setting for Height. 356 mm is the international factory default setting for Height.</li> <li>• Portrait is the factory default setting for Orientation.</li> <li>• Off is the factory default setting for 2 scans per side.</li> </ul>

## Universal Setup menu

Use	To
<b>Units of Measure</b> Inches Millimeters	Identify the units of measure.  <b>Notes:</b> <ul style="list-style-type: none"> <li>• Inches is the US factory default setting.</li> <li>• Millimeters is the international factory default setting.</li> </ul>
<b>Portrait Width</b> 3–8.5 inches 76–216 mm	Set the portrait width.  <b>Notes:</b> <ul style="list-style-type: none"> <li>• If the width exceeds the maximum, then the printer uses the maximum width allowed.</li> <li>• 8.5 inches is the US factory default setting. You can increase the width in 0.01-inch increments.</li> <li>• 216 mm is the international factory default setting. You can increase the width in 1-mm increments.</li> </ul>
<b>Portrait Height</b> 3–14.17 inches 76–360 mm	Set the portrait height.  <b>Notes:</b> <ul style="list-style-type: none"> <li>• If the height exceeds the maximum, then the printer uses the maximum height allowed.</li> <li>• 14 inches is the US factory default setting. You can increase the height in 0.01-inch increments.</li> <li>• 356 mm is the international factory default setting. You can increase the height in 1-mm increments.</li> </ul>
<b>Feed Direction</b> Short Edge Long Edge	Specify the feed direction if the paper can be loaded in either direction.  <b>Notes:</b> <ul style="list-style-type: none"> <li>• Short Edge is the factory default setting.</li> <li>• Long Edge appears only when the longest edge is shorter than the maximum width supported in the tray.</li> </ul>

## Reports menu

Use	To
<b>Menu Settings Page</b>	Print a report on the current printer menu settings. The report also contains information about the status of the supplies and a list of hardware options that are successfully installed.
<b>Device Statistics</b>	Print a report containing printer statistics, such as supply information and number of printed pages.
<b>Network Setup Page</b>	Print a report containing information about the network settings of the printer. <b>Note:</b> This menu item appears only in network printers or printers connected to print servers.
<b>Network [x] Setup Page</b>	Print a report containing information about the network settings of the printer. <b>Note:</b> This menu item appears only in network printers or printers connected to print servers, and when there is more than one network option installed.
<b>Shortcut List</b>	Print a report containing information about configured shortcuts.
<b>Fax Job Log</b>	Print a report containing information about the last 200 completed faxes. <b>Notes:</b> <ul style="list-style-type: none"> <li>• This menu item appears only when Enable Job Log is set to On in the Fax Settings menu.</li> <li>• This menu is supported only in some printer models.</li> </ul>
<b>Fax Call Log</b>	Print a report containing information about the last 100 attempted, received, and blocked calls. <b>Notes:</b> <ul style="list-style-type: none"> <li>• This menu item appears only when Enable Job Log is set to On in the Fax Settings menu.</li> <li>• This menu is supported only in some printer models.</li> </ul>
<b>Copy Shortcuts</b>	Print a report containing information about copy shortcuts.
<b>E-mail Shortcuts</b>	Print a report containing information about e-mail shortcuts.
<b>Fax Shortcuts</b>	Print a report containing information about fax shortcuts.
<b>FTP Shortcuts</b>	Print a report containing information about FTP shortcuts.
<b>Profiles List</b>	Print a list of profiles stored in the printer.
<b>Print Fonts</b>	Print a report of all the fonts available for the printer language currently set in the printer.
<b>Print Directory</b>	Print a list of all the resources stored in an optional flash memory card or printer hard disk. <b>Notes:</b> <ul style="list-style-type: none"> <li>• Job Buffer Size must be set to 100%.</li> <li>• Make sure that the memory card or hard disk is installed and working properly.</li> </ul>

Use	To
<b>Print Demo</b> Demo Page [list of available demo pages]	Print demo files that are available in the firmware, the flash option, and the disk option.
<b>Asset Report</b>	Print a report containing printer asset information, such as serial number and model name.
<b>Event Log Summary</b>	Print a summary of logged events.

## Network/Ports

### Active NIC menu

Use	To
<b>Active NIC</b> Auto [list of available network cards]	Allow the printer to connect to a network.  <b>Notes:</b> <ul style="list-style-type: none"> <li>• Auto is the factory default setting.</li> <li>• This menu item appears only if an optional network adapter is installed.</li> </ul>

### Standard Network or Network [x] menu

**Note:** Only active ports appear in this menu.

Use	To
<b>Energy Efficient Ethernet</b> Enable Disable	Reduce power consumption when the printer receives no data from the Ethernet network.  <b>Note:</b> Enable is the factory default setting.
<b>PCL SmartSwitch</b> On Off	Set the printer to automatically switch to PCL emulation when a print job requires it, regardless of the default printer language.  <b>Notes:</b> <ul style="list-style-type: none"> <li>• On is the factory default setting.</li> <li>• If PCL SmartSwitch is disabled, then the printer does not examine incoming data and it uses the default printer language specified in the Setup menu.</li> </ul>
<b>PS SmartSwitch</b> On Off	Set the printer to automatically switch to PS emulation when a print job requires it, regardless of the default printer language.  <b>Notes:</b> <ul style="list-style-type: none"> <li>• On is the factory default setting.</li> <li>• If PS SmartSwitch is disabled, then the printer does not examine incoming data and it uses the default printer language specified in the Setup menu.</li> </ul>

Use	To
<b>NPA Mode</b> Off Auto	Set the printer to perform the special processing required for bidirectional communication following the conventions defined by the NPA protocol.  <b>Notes:</b> <ul style="list-style-type: none"> <li>• Auto is the factory default setting.</li> <li>• The printer automatically restarts when the setting is changed from the control panel.</li> </ul>
<b>Network Buffer</b> Auto 3KB to [maximum size allowed]	Set the size of the network input buffer.  <b>Notes:</b> <ul style="list-style-type: none"> <li>• Auto is the factory default setting.</li> <li>• The maximum size allowed depends on the amount of memory in the printer, the size of the other link buffers, and whether Resource Save is set to On or Off.</li> <li>• To increase the maximum size range for the Network Buffer, disable or reduce the size of the parallel, serial, and USB buffers.</li> <li>• The printer automatically restarts when the setting is changed from the control panel.</li> </ul>
<b>Job Buffering</b> Off On Auto	Temporarily store print jobs in the printer hard disk before printing. This menu only appears when a formatted disk is installed.  <b>Notes:</b> <ul style="list-style-type: none"> <li>• Off is the factory default setting.</li> <li>• The printer automatically restarts when the setting is changed from the control panel. The menu selection is then updated.</li> </ul>
<b>Mac Binary PS</b> On Off Auto	Set the printer to process Macintosh binary PostScript print jobs.  <b>Note:</b> Auto is the factory default setting.
<b>Standard Network Setup OR Network [x] Setup</b> Reports Network Card TCP/IP IPv6 Wireless AppleTalk	Show and set the printer network settings.  <b>Note:</b> The Wireless menu appears only when the printer is connected to a wireless network.

## Reports menu

To access the menu, navigate to either of the following:

- **Network/Ports > Standard Network > Standard Network Setup > Reports**
- **Network/Ports > Network [x] > Network [x] Setup > Reports**

Use	To
<b>Print Setup Page</b>	Print a report containing information about the network printer settings, such as the TCP/IP address.

## Network Card menu

To access the menu, navigate to either of the following:

- **Network/Ports > Standard Network > Standard Network Setup > Network Card**
- **Network/Ports > Network [x] > Network [x] Setup > Network Card**

Use	To
<b>View Card Status</b> Connected Disconnected	View the connection status of the wireless network adapter.
<b>View Card Speed</b>	View the speed of an active wireless network adapter.
<b>Network Address</b> UAA LAA	View the network addresses.
<b>Job Timeout</b> 0, 10–225 seconds	Set the amount of time it takes for a network print job to be canceled. <b>Notes:</b> <ul style="list-style-type: none"> <li>• “90 seconds” is the factory default setting.</li> <li>• A setting value of 0 disables the timeout.</li> <li>• If a value between 1 and 9 is selected, then <b>Invalid</b> appears on the display, and the value is not saved.</li> </ul>
<b>Banner Page</b> Off On	Allow the printer to print a banner page. <b>Note:</b> Off is the factory default setting.

## TCP/IP menu

To access the menu, navigate to either of the following:

- **Network/Ports > Standard Network > Standard Network Setup > TCP/IP**
- **Network/Ports > Network [x] > Network [x] Setup > TCP/IP**

**Note:** This menu is available only in network printers or printers that are attached to print servers.

Use	To
<b>Set Hostname</b>	Set the current TCP/IP hostname.
<b>IP Address</b>	View or change the current TCP/IP address. <b>Note:</b> Manually setting the IP address sets the Enable DHCP and Enable Auto IP settings to Off. It also sets Enable BOOTP and Enable RARP to Off on systems that support BOOTP and RARP.
<b>Netmask</b>	View or change the current TCP/IP netmask.
<b>Gateway</b>	View or change the current TCP/IP gateway.

Use	To
<b>Enable DHCP</b> On Off	Specify the DHCP address and parameter assignment. <b>Note:</b> On is the factory default setting.
<b>Enable RARP</b> On Off	Specify the RARP address assignment setting. <b>Note:</b> Off is the factory default setting.
<b>Enable BOOTP</b> On Off	Specify the BOOTP address assignment setting. <b>Note:</b> On is the factory default setting.
<b>Enable AutoIP</b> Yes No	Specify the Zero Configuration Networking setting. <b>Note:</b> Yes is the factory default setting.
<b>Enable FTP/TFTP</b> Yes No	Send files to the printer using the built-in FTP server. <b>Note:</b> Yes is the factory default setting.
<b>Enable HTTP Server</b> Yes No	Enable the built-in Web server (Embedded Web Server) which lets you monitor and manage the printer remotely using a Web browser. <b>Note:</b> Yes is the factory default setting.
<b>WINS Server Address</b>	View or change the current WINS server address.
<b>Enable DDNS</b> Yes No	View or change the current DDNS setting. <b>Note:</b> Yes is the factory default setting.
<b>Enable mDNS</b> Yes No	View or change the current mDNS setting. <b>Note:</b> Yes is the factory default setting.
<b>DNS Server Address</b>	View or change the current DNS server address.
<b>Backup DNS Server Address [x]</b>	View or change the current DNS server address.
<b>Enable HTTPS</b> Yes No	View or change the current HTTPS setting. <b>Note:</b> Yes is the factory default setting.

## IPv6 menu

To access the menu, navigate to any of the following:

- **Network/Ports menu > Standard Network > Standard Network Setup > IPv6**
- **Network/Ports menu > Network [x] > Network [x] Setup > IPv6**

**Note:** This menu is available only in network printers or printers that are attached to print servers.

Use	To
<b>Enable IPv6</b> On Off	Enable IPv6 in the printer. <b>Note:</b> On is the factory default setting.
<b>Auto Configuration</b> On Off	Specify whether or not the network adapter accepts the automatic IPv6 address configuration entries provided by a router. <b>Note:</b> On is the factory default setting.
<b>Set Hostname</b>	Set the host name.
<b>View Address</b>	<b>Note:</b> These settings can be changed only from the Embedded Web Server.
<b>View Router Address</b>	
<b>Enable DHCPv6</b> On Off	Enable DHCPv6 in the printer. <b>Note:</b> On is the factory default setting.

## Wireless menu

**Note:** This menu is available only in printers connected to a wireless network or printer models that have a wireless network adapter.

To access the menu, navigate to:

**Network/Ports > Network [x] > Network [x] Setup > Wireless**

Use	To
<b>Wi-Fi Protected Setup</b> Start Push Button Method Start PIN Method	Establish a wireless network and enable network security. <b>Notes:</b> <ul style="list-style-type: none"> <li>Start Push Button Method connects the printer to a wireless network when buttons on both the printer and the access point (wireless router) are pressed within a given period of time.</li> <li>Start PIN Method connects the printer to a wireless network when a PIN on the printer is entered into the wireless settings of the access point.</li> </ul>
<b>Enable/Disable WPS Auto-detection</b> Enable Disable	Automatically detect the connection method that an access point with WPS uses—Start Push Button Method or Start PIN Method. <b>Note:</b> Disable is the factory default setting.
<b>Network Mode</b> BSS Type Infrastructure Ad hoc	Specify the network mode. <b>Notes:</b> <ul style="list-style-type: none"> <li>Infrastructure is the factory default setting. This lets the printer access a network using an access point.</li> <li>Ad hoc configures wireless connection directly between the printer and a computer.</li> </ul>
<b>Compatibility</b> 802.11b/g 802.11b/g/n	Specify the wireless standard for the wireless network. <b>Note:</b> 802.11b/g/n is the factory default setting.

Use	To
<b>Choose Network</b>	Select an available network for the printer to use.
<b>View Signal Quality</b>	View the quality of the wireless connection.
<b>View Security Mode</b>	View the encryption method for the wireless network.

## AppleTalk menu

To access the menu, navigate to either of the following:

- **Network/Ports > Standard Network > Standard Network Setup > AppleTalk**
- **Network/Ports > Network [x] > Network [x] Setup > AppleTalk**

Use	To
<b>Activate</b> Yes No	Enable or disable AppleTalk support. <b>Note:</b> No is the factory default setting.
<b>View Name</b>	Show the assigned AppleTalk name. <b>Note:</b> The AppleTalk name can be changed only from the Embedded Web Server.
<b>View Address</b>	Show the assigned AppleTalk address. <b>Note:</b> The AppleTalk address can be changed only from the Embedded Web Server.
<b>Set Zone</b> [list of zones available on the network]	Provide a list of AppleTalk zones available on the network. <b>Note:</b> The default zone for the network is the factory default setting.

## Standard USB menu

Use	To
<b>PCL SmartSwitch</b> On Off	Set the printer to automatically switch to PCL emulation when a print job received through a USB port requires it, regardless of the default printer language. <b>Notes:</b> <ul style="list-style-type: none"> <li>• On is the factory default setting.</li> <li>• When set to Off, the printer does not examine incoming data. The printer uses PostScript emulation if the PS SmartSwitch is set to On. It uses the default printer language specified in the Setup menu if the PS SmartSwitch is set to Off.</li> </ul>
<b>PS SmartSwitch</b> On Off	Set the printer to automatically switch to PS emulation when a print job received through a USB port requires it, regardless of the default printer language. <b>Notes:</b> <ul style="list-style-type: none"> <li>• On is the factory default setting.</li> <li>• When set to Off, the printer does not examine incoming data. The printer uses PCL emulation if the PCL SmartSwitch is set to On. It uses the default printer language specified in the Setup menu if the PCL SmartSwitch is set to Off.</li> </ul>



Use	To
<b>NPA Mode</b> On Off Auto	Set the printer to perform the special processing required for bidirectional communication following the conventions defined by the NPA protocol.  <b>Notes:</b> <ul style="list-style-type: none"> <li>• Auto is the factory default setting. Auto sets the printer to examine data, determine the format, and then process it appropriately.</li> <li>• The printer automatically restarts when changing the setting from the printer control panel. The menu selection is then updated.</li> </ul>
<b>USB Buffer</b> Disabled Auto 3K to [maximum size allowed]	Set the size of the USB input buffer.  <b>Notes:</b> <ul style="list-style-type: none"> <li>• Auto is the factory default setting.</li> <li>• Disabled turns off job buffering. Any jobs already buffered on the printer hard disk are printed before normal processing resumes.</li> <li>• The USB buffer size value can be changed in 1-K increments.</li> <li>• The maximum size allowed depends on the amount of memory in the printer, the size of the other link buffers, and whether Resource Save is set to On or Off.</li> <li>• To increase the maximum size range for the USB Buffer, disable or reduce the size of the parallel, serial, and network buffers.</li> <li>• The printer automatically restarts when the setting is changed from the printer control panel. The menu selection is then updated.</li> </ul>
<b>Job Buffering</b> Off On Auto	Temporarily store print jobs in the printer hard disk before printing.  <b>Notes:</b> <ul style="list-style-type: none"> <li>• Off is the factory default setting.</li> <li>• On buffers jobs on the printer hard disk.</li> <li>• Auto buffers print jobs only if the printer is busy processing data from another input port.</li> <li>• Changing this setting from the printer control panel and then exiting the menus causes the printer to restart. The menu selection is then updated.</li> </ul>
<b>Mac Binary PS</b> On Off Auto	Set the printer to process Macintosh binary PostScript print jobs.  <b>Notes:</b> <ul style="list-style-type: none"> <li>• Auto is the factory default setting.</li> <li>• On processes raw binary PostScript print jobs.</li> <li>• Off filters print jobs using the standard protocol.</li> </ul>
<b>ENA Address</b> YYY.YYY.YYY.YYY	Set the network address information for an external print server.  <b>Note:</b> This menu is available only when the printer is attached to an external print server through the USB port.
<b>ENA Netmask</b> YYY.YYY.YYY.YYY	Set the netmask information for an external print server.  <b>Note:</b> This menu is available only when the printer is attached to an external print server through the USB port.

Use	To
<b>ENA Gateway</b> YYY.YYY.YYY.YYY	Set the gateway information for an external print server. <b>Note:</b> This menu is available only when the printer is attached to an external print server through the USB port.

## SMTP Setup menu

Use	To
<b>Primary SMTP Gateway</b>	Specify SMTP server gateway and port information. <b>Note:</b> 25 is the default SMTP gateway port.
<b>Primary SMTP Gateway Port</b>	
<b>Secondary SMTP Gateway</b>	
<b>Secondary SMTP Gateway Port</b>	
<b>SMTP Timeout</b> 5–30	Specify the amount of time in seconds before the server stops trying to send an e-mail. <b>Note:</b> 30 is the factory default setting.
<b>Reply Address</b>	Specify a reply address of up to 128 characters in the e-mail sent by the printer.
<b>Use SSL</b> Disabled Negotiate Required	Set the printer to use SSL for increased security when connecting to the SMTP server. <b>Notes:</b> <ul style="list-style-type: none"> <li>• Disabled is the factory default setting.</li> <li>• When the Negotiate setting is used, the SMTP server determines if SSL will be used.</li> </ul>
<b>SMTP Server Authentication</b> No authentication required Login/Plain CRAM-MD5 Digest-MD5 NTLM Kerberos 5	Specify the type of user authentication required for scan to e-mail privileges. <b>Note:</b> “No authentication required” is the factory default setting.

Use	To
<b>Device-Initiated E-mail</b> None Use Device SMTP Credentials	Specify what credentials will be used when communicating to the SMTP server.  <b>Notes:</b> <ul style="list-style-type: none"> <li>• None is the factory default setting for Device-Initiated E-mail and User-Initiated E-mail.</li> <li>• “Device Userid” and “Device password” are used to log in to the SMTP server when Use Device SMTP Credentials is selected.</li> </ul>
<b>User-Initiated E-mail</b> None Use Device SMTP Credentials Use Session User ID and Password Use Session E-mail address and Password Prompt user	
<b>Device Userid</b>	
<b>Device password</b>	
<b>Kerberos 5 Realm</b>	
<b>NTLM Domain</b>	

## Security menu

### Edit Security Setups menu

Use	To
<b>Edit Backup Password</b>	Create a backup password. <b>Note:</b> This menu item appears only when a backup password exists.
<b>Edit Building Blocks</b>	Edit the internal accounts, NTLM, various setups, password, and PIN.
<b>Edit Security Templates</b>	Add or edit a security template.
<b>Edit Access Controls</b>	Control access to printer menus, firmware updates, held jobs, and other access points.

## Miscellaneous Security Settings menu

Use	To
<p><b>Login Restrictions</b></p> <ul style="list-style-type: none"> <li>Login failures</li> <li>Failure time frame</li> <li>Lockout time</li> <li>Panel Login Timeout</li> <li>Remote Login Timeout</li> </ul>	<p>Limit the number and time frames of failed login attempts from the printer control panel before <i>all</i> users are locked out.</p> <p><b>Notes:</b></p> <ul style="list-style-type: none"> <li>• “Login failures” specifies the number of failed login attempts before users are locked out. Settings range from 1 to 10 attempts. “3 attempts” is the factory default setting.</li> <li>• “Failure time frame” specifies the time frame during which failed login attempts can be made before users are locked out. Settings range from 1 to 60 minutes. “5 minutes” is the factory default setting.</li> <li>• “Lockout time” specifies how long users are locked out after exceeding the login failures limit. Settings range from 1 to 60 minutes. “5 minutes” is the factory default setting. 1 indicates that the printer does not impose a lockout time.</li> <li>• Panel Login Timeout specifies how long the printer remains idle on the home screen before automatically logging off the user. Settings range from 1 to 900 seconds. “30 seconds” is the factory default setting.</li> <li>• Remote Login Timeout specifies how long a remote interface remains idle before automatically logging off the user. Settings range from 1 to 120 minutes. “10 minutes” is the factory default setting.</li> </ul>
<p><b>Security Reset Jumper</b></p> <ul style="list-style-type: none"> <li>No Effect</li> <li>Access controls=“No Security”</li> <li>Reset factory security defaults</li> </ul>	<p>Adjust the security settings.</p> <p><b>Notes:</b></p> <ul style="list-style-type: none"> <li>• No Effect means the reset has no effect on the printer security configuration.</li> <li>• Access controls=‘No Security’ retains all the security information that the user has defined. No Security is the factory default setting.</li> <li>• “Reset factory security defaults” deletes all security information that the user has defined, and restores the factory default settings in the Miscellaneous Security menu.</li> </ul>
<p><b>LDAP Certificate Verification</b></p> <ul style="list-style-type: none"> <li>Demand</li> <li>Try</li> <li>Allow</li> <li>Never</li> </ul>	<p>Allow the user to request a server certificate.</p> <p><b>Notes:</b></p> <ul style="list-style-type: none"> <li>• “Demand” is the factory default setting. This means a server certificate is requested. If a bad certificate is provided or if no certificate is provided, then the session is terminated immediately.</li> <li>• “Try” means a server certificate is requested. If no certificate is provided, then the session proceeds normally. If a bad certificate is provided, then the session is terminated immediately.</li> <li>• “Allow” means a server certificate is requested. If no certificate is provided, then the session proceeds normally. If a bad certificate is provided, then it will be ignored and the session proceeds normally.</li> <li>• “Never” means no server certificate is requested.</li> </ul>
<p><b>Minimum PIN Length</b></p> <ul style="list-style-type: none"> <li>1–16</li> </ul>	<p>Limit the digit length of the personal identification number (PIN).</p> <p><b>Note:</b> 4 is the factory default setting.</p>

## Confidential Print menu

Use	To
<b>Max Invalid PIN</b> Off 2–10	Set a limit on the number of times an invalid PIN can be entered.  <b>Notes:</b> <ul style="list-style-type: none"> <li>• This menu item appears only when a formatted, working printer hard disk is installed.</li> <li>• When the limit is reached, the print jobs for that user name and PIN are deleted.</li> </ul>
<b>Confidential Job Expiration</b> Off 1 hour 4 hours 24 hours 1 week	Set a limit on how long the printer stores confidential print jobs.  <b>Notes:</b> <ul style="list-style-type: none"> <li>• If the “Confidential Job Expiration” setting is changed while confidential print jobs reside in the printer memory or printer hard disk, then the expiration time for those print jobs does not change to the new default value.</li> <li>• If the printer is turned off, then all confidential jobs held in the printer memory are deleted.</li> </ul>
<b>Repeat Job Expiration</b> Off 1 hour 4 hours 24 hours 1 week	Set a limit on how long the printer stores print jobs.
<b>Verify Job Expiration</b> Off 1 hour 4 hours 24 hours 1 week	Set a limit on how long the printer stores print jobs needing verification.
<b>Reserve Job Expiration</b> Off 1 hour 4 hours 24 hours 1 week	Set a limit on how long the printer stores print jobs for printing at a later time.
<b>Note:</b> Off is the factory default setting.	

## Erase Temporary Data Files menu

Erase Temporary Data Files deletes *only* print job data on the printer hard disk that *are not* currently in use by the file system. All permanent data on the printer hard disk are preserved, such as downloaded fonts, macros, and held jobs.

**Note:** This menu appears only when a formatted, working printer hard disk is installed.

Use	To
<b>Wiping Mode</b> Auto	Specify the mode for erasing temporary data files.

Use	To
<p><b>Automatic Method</b>                      Single pass                      Multiple pass</p>	<p>Mark all disk space used by a previous print job. This method does not permit the file system to reuse this space until it has been cleared.</p> <p><b>Notes:</b></p> <ul style="list-style-type: none"> <li>• “Single pass” is the factory default setting.</li> <li>• Only automatic wiping enables users to erase temporary data files without having to turn off the printer for an extended amount of time.</li> <li>• Highly confidential information should be erased using <i>only</i> the Multiple pass method.</li> </ul>

### Security Audit Log menu

Use	To
<p><b>Export Log</b></p>	<p>Enable an authorized user to export the security log.</p> <p><b>Notes:</b></p> <ul style="list-style-type: none"> <li>• To export the log from the printer control panel, attach a flash drive to the printer.</li> <li>• To export the log from the Embedded Web Server, download the log to a computer.</li> </ul>
<p><b>Delete Log</b>                      Yes                      No</p>	<p>Specify whether audit logs are deleted.</p>
<p><b>Configure Log</b>                      Enable Audit                          Yes                          No                      Enable Remote Syslog                          No                          Yes                      Remote Syslog Server                          [256 character string]                      Remote Syslog Port                          1–65535                      Remote Syslog Method                          Normal UDP                          Stunnel                      Remote Syslog Facility                          0–23                      Log full behavior                          Wrap over oldest entries                          E-mail log then delete all entries</p>	<p>Specify how audit logs are configured.</p> <p><b>Notes:</b></p> <ul style="list-style-type: none"> <li>• Enable Audit determines if events are recorded in the secure audit log and remote syslog. No is the factory default setting.</li> <li>• Enable Remote Syslog determines if logs are sent to a remote server. No is the factory default setting.</li> <li>• Remote Syslog Server determines the value used to send logs to the remote syslog server.</li> <li>• Remote Syslog Port identifies the port over which the printer transmits logged events to a remote server.</li> <li>• Remote Syslog Method identifies the protocol used by the printer to transmit logged events to a remote server. Normal UDP is the factory default setting.</li> <li>• Remote Syslog Facility determines the Facility value that the printer uses when sending events to the remote syslog server. 4 is the factory default setting.</li> <li>• “Log full behavior” determines how the printer resolves if the log entirely fills its allotted memory. “Wrap over oldest entries” is the factory default setting.</li> </ul>

Use	To
<p><b>Configure Log (continued)</b></p> <p>Admin’s e-mail address [256 character string]</p> <p>Digitally sign exports Off On</p> <p>Severity of events to log 0–7</p> <p>Remote Syslog non-logged events No Yes</p> <p>E-mail log cleared alert No Yes</p> <p>E-mail log wrapped alert No Yes</p> <p>E-mail % full alert No Yes</p> <p>% full alert level 1–99</p> <p>E-mail log exported alert No Yes</p> <p>E-mail log settings changed alert No Yes</p> <p>Log line endings LF (\n) CR (\r) CRLF (\r\n)</p>	<p>Specify how audit logs are configured.</p> <p><b>Notes:</b></p> <ul style="list-style-type: none"> <li>• “Admin’s e-mail address” determines if administrators are automatically notified of certain log events. This setting can have one or more e-mail addresses (separated by commas).</li> <li>• “Digitally sign exports” determines if the printer automatically signs each exported security log. Off is the factory default setting.</li> <li>• “Severity of events to log” records the severity value of each event. 4 is the factory default setting.</li> <li>• “Remote Syslog non-logged events” determines if the printer sends events to the remote server that have a severity level greater than the value of the “Severity of events to log” setting. No is the factory default setting.</li> <li>• “E-mail log cleared alert” determines if the printer sends an e-mail to the administrator every time a log is deleted through the printer control panel or EWS. No is the factory default setting.</li> <li>• “E-mail log wrapped alert” determines if the printer sends the administrator an e-mail when log entries are wrapping. No is the factory default setting.</li> <li>• “E-mail % full alert” determines if the printer sends the administrator an e-mail when the log fills a certain amount of its allotted space. No is the factory default setting.</li> <li>• “% full alert level” determines if the space occupied by log equals or exceeds the value of the full alert level. 90 is the factory default setting.</li> <li>• “E-mail log exported alert” determines if the printer sends the administrator an e-mail when there is a log exported. No is the factory default setting.</li> <li>• “E-mail log settings changed alert” determines if the printer sends the administrator an e-mail when the value of the Enable Audit Log setting is toggled. No is the factory default setting.</li> <li>• “Log line endings” specifies how line endings will be handled in the log file, depending on the operating system in which the file will be parsed or viewed. “LF (\n)” is the factory default setting.</li> </ul>

### Set Date/Time menu

Use	To
<b>Current Date and Time</b>	View the current date and time settings for the printer.
<b>Manually Set Date and Time</b>	Enter the date and time. <b>Note:</b> Date/Time is set in YYYY-MM-DD HH:MM:SS format.
<b>Time Zone</b>	Select the time zone. <b>Note:</b> GMT is the factory default setting.

Use	To
<b>Automatically Observe DST</b> On Off	Set the printer to use the applicable daylight saving time (DST) start and end times associated with the printer Time Zone setting. <b>Note:</b> On is the factory default setting and uses the applicable Daylight Saving Time associated with the Time Zone setting.
<b>Custom Time Zone Setup</b> DST Start Week DST Start Day DST Start Month DST Start Time DST End Week DST End Day DST End Month DST End Time DST Offset	Enable the user to set up the time zone.
<b>Enable NTP</b> On Off	Enable Network Time Protocol, which synchronizes the clocks of devices on a network. <b>Note:</b> On is the factory default setting.
<b>NTP Server</b>	View the NTP server address.
<b>Enable Authentication</b> On Off	Change the authentication setting to On or Off. <b>Note:</b> Off is the factory default setting.



# Settings menu

## General Settings menu

Use	To
<b>Display Language</b> English Francais Deutsch Italiano Espanol Dansk Norsk Nederlands Svenska Portugues Suomi Russian Polski Greek Magyar Turkce Cesky Simplified Chinese Traditional Chinese Korean Japanese	Set the language of the text appearing on the display. <b>Note:</b> Not all languages are available for all models. You may need to install a special hardware for some languages.
<b>Show Supply Estimates</b> Show estimates Do not show estimates	View the estimates of the supplies on the control panel, Embedded Web Server, menu settings, and device statistics reports. <b>Note:</b> Show estimates is the factory default setting.
<b>Eco-Mode</b> Off Energy Energy/Paper Paper	Minimize the use of energy, paper, or specialty media. <b>Notes:</b> <ul style="list-style-type: none"> <li>• Off is the factory default setting. This resets the printer to its factory default settings.</li> <li>• When setting Eco-Mode to Energy or Paper, performance may be affected, but print quality is not.</li> </ul>
<b>ADF Loaded Beep</b> Enabled Disabled	Specify whether the ADF sounds a beep when paper is loaded. <b>Note:</b> Enabled is the factory default setting.
<b>Quiet Mode</b> Off On	Minimize the printer noise. <b>Note:</b> Off is the factory default setting.

Use	To
<p><b>Run Initial setup</b></p> <p>Yes</p> <p>No</p>	<p>Run the setup wizard.</p>
<p><b>Keyboard</b></p> <p>Keyboard Type</p> <p>English</p> <p>Francais</p> <p>Francais Canadien</p> <p>Deutsch</p> <p>Italiano</p> <p>Espanol</p> <p>Greek</p> <p>Dansk</p> <p>Norsk</p> <p>Nederlands</p> <p>Svenska</p> <p>Suomi</p> <p>Portugues</p> <p>Russian</p> <p>Polski</p> <p>Swiss German</p> <p>Swiss French</p> <p>Korean</p> <p>Magyar</p> <p>Turkce</p> <p>Cesky</p> <p>Simplified Chinese</p> <p>Traditional Chinese</p> <p>Japanese</p> <p>Custom Key [x]</p>	<p>Specify a language and custom key information for the display keyboard.</p>
<p><b>Paper Sizes</b></p> <p>U.S.</p> <p>Metric</p>	<p>Specify the unit of measurement for paper sizes.</p> <p><b>Notes:</b></p> <ul style="list-style-type: none"> <li>• U.S. is the factory default setting.</li> <li>• The initial setting is determined by your country or region selection in the initial setup wizard.</li> </ul>
<p><b>Scan to PC Port Range</b></p> <p>[port range]</p>	<p>Specify a valid port range for printers behind a port blocking firewall.</p> <p><b>Note:</b> 9751:12000 is the factory default setting.</p>

Use	To
<p><b>Displayed Information</b></p> <ul style="list-style-type: none"> <li>Left side</li> <li>Right side</li> <li>Custom Text [x]</li> </ul>	<p>Specify what is displayed in the upper corners of the home screen.</p> <p>For Left side and Right side, select from the following options:</p> <ul style="list-style-type: none"> <li>None</li> <li>IP Address</li> <li>Hostname</li> <li>Contact Name</li> <li>Location</li> <li>Date/Time</li> <li>mDNS/DDNS Service Name</li> <li>Zero Configuration Name</li> <li>Custom Text [x]</li> <li>Model Name</li> </ul> <p><b>Notes:</b></p> <ul style="list-style-type: none"> <li>• IP Address is the factory default setting for Left side.</li> <li>• Date/Time is the factory default setting for Right side.</li> </ul>
<p><b>Displayed Information (continued)</b></p> <ul style="list-style-type: none"> <li>Black Toner</li> <li>Cyan Toner</li> <li>Magenta Toner</li> <li>Yellow Toner</li> <li>Fuser</li> <li>Transfer Module</li> </ul>	<p>Customize the displayed information for supplies.</p> <p>Select from the following options:</p> <ul style="list-style-type: none"> <li>When to display                             <ul style="list-style-type: none"> <li>Do not display</li> <li>Display</li> </ul> </li> <li>Message to display                             <ul style="list-style-type: none"> <li>Default</li> <li>Alternate</li> </ul> </li> <li>Default                             <ul style="list-style-type: none"> <li>[text entry]</li> </ul> </li> <li>Alternate                             <ul style="list-style-type: none"> <li>[text entry]</li> </ul> </li> </ul> <p><b>Note:</b> Do not display is the factory default setting for When to display.</p>
<p><b>Displayed Information (continued)</b></p> <ul style="list-style-type: none"> <li>Waste Toner Bottle</li> <li>Paper Jam</li> <li>Load Paper</li> <li>Service Errors</li> </ul>	<p>Customize the displayed information for certain menus.</p> <p>Select from the following options:</p> <ul style="list-style-type: none"> <li>Display                             <ul style="list-style-type: none"> <li>Yes</li> <li>No</li> </ul> </li> <li>Message to display                             <ul style="list-style-type: none"> <li>Default</li> <li>Alternate</li> </ul> </li> <li>Default                             <ul style="list-style-type: none"> <li>[text entry]</li> </ul> </li> <li>Alternate                             <ul style="list-style-type: none"> <li>[text entry]</li> </ul> </li> </ul> <p><b>Note:</b> No is the factory default setting for Display.</p>

Use	To
<p><b>Home screen customization</b></p> <ul style="list-style-type: none"> <li>Change Language</li> <li>Copy</li> <li>Copy Shortcuts</li> <li>Fax</li> <li>Fax Shortcuts</li> <li>E-mail</li> <li>E-mail Shortcuts</li> <li>FTP</li> <li>FTP Shortcuts</li> <li>Search Held Jobs</li> <li>Held Jobs</li> <li>USB Drive</li> <li>Profiles and Apps</li> <li>Bookmarks</li> <li>Jobs by User</li> <li>Forms and Favorites</li> <li>Card Copy</li> <li>Scan to Network</li> <li>MyShortcut</li> <li>Multi Send</li> </ul>	<p>Change the icons that appear on the home screen.</p> <p>For each icon, select from the following options:</p> <ul style="list-style-type: none"> <li>Display</li> <li>Do not display</li> </ul>
<p><b>Date Format</b></p> <ul style="list-style-type: none"> <li>MM-DD-YYYY</li> <li>DD-MM-YYYY</li> <li>YYYY-MM-DD</li> </ul>	<p>Format the date.</p> <p><b>Note:</b> MM-DD-YYYY is the U.S. factory default setting. DD-MM-YYYY is the international factory default setting.</p>
<p><b>Time Format</b></p> <ul style="list-style-type: none"> <li>12 hour A.M./P.M.</li> <li>24 hour clock</li> </ul>	<p>Format the time.</p> <p><b>Note:</b> 12 hour A.M./P.M. is the factory default setting.</p>
<p><b>Screen Brightness</b></p> <ul style="list-style-type: none"> <li>20–100</li> </ul>	<p>Specify the brightness of the display.</p> <p><b>Note:</b> 100 is the factory default setting.</p>
<p><b>One Page Copy</b></p> <ul style="list-style-type: none"> <li>Off</li> <li>On</li> </ul>	<p>Set copies from the scanner glass to only one page at a time.</p> <p><b>Note:</b> Off is the factory default setting.</p>
<p><b>Audio Feedback</b></p> <ul style="list-style-type: none"> <li>Button Feedback <ul style="list-style-type: none"> <li>On</li> <li>Off</li> </ul> </li> <li>Volume <ul style="list-style-type: none"> <li>1–10</li> </ul> </li> </ul>	<p>Set the audio volume for the buttons.</p> <p><b>Notes:</b></p> <ul style="list-style-type: none"> <li>• On is the factory default setting for Button Feedback.</li> <li>• 5 is the factory default setting for Volume.</li> </ul>
<p><b>Show Bookmarks</b></p> <ul style="list-style-type: none"> <li>Yes</li> <li>No</li> </ul>	<p>Specify whether bookmarks are displayed from the Held Jobs area.</p> <p><b>Note:</b> Yes is the factory default setting.</p>

Use	To
<b>Allow Background Removal</b> On Off	Specify whether image background removal is allowed. <b>Note:</b> On is the factory default setting.
<b>Allow Custom Job Scans</b> On Off	Scan multiple jobs to one file. <b>Note:</b> On is the factory default setting. If On is selected, then the Allow Custom Job Scans setting can be enabled for specific jobs.
<b>Scanner Jam Recovery</b> Job level Page level	Specify how a scanned job should be reloaded if a paper jam occurs in the ADF. <b>Notes:</b> <ul style="list-style-type: none"> <li>• Job level is the factory default setting. If Job level is selected, then rescan the entire job.</li> <li>• If Page level is selected, then rescan from the jammed page forward.</li> </ul>
<b>Web Page Refresh Rate</b> 30–300	Specify the number of seconds between Embedded Web Server refreshes. <b>Note:</b> 120 is the factory default setting.
<b>Contact Name</b>	Specify a contact name. <b>Note:</b> The contact name is stored on the Embedded Web Server.
<b>Location</b>	Specify the location. <b>Note:</b> The location is stored on the Embedded Web Server.
<b>Alarms</b> Alarm Control Cartridge Alarm	Set an alarm when the printer requires user intervention. For each alarm type, select from the following options: Off Single Continuous <b>Notes:</b> <ul style="list-style-type: none"> <li>• Single is the factory default setting for Alarm Control and Cartridge Alarm. This sounds several quick beeps.</li> <li>• Continuous repeats several quick beeps in a regular interval.</li> </ul>
<b>Timeouts</b> Standby Mode Disabled 1–240	Set the amount of time before the printer enters a lower power state. <b>Note:</b> 15 minutes is the factory default setting.

Use	To
<b>Timeouts</b> Sleep Mode Disabled 1–120	Set the amount of time the printer waits after a job is printed before it goes into a reduced power state.  <b>Notes:</b> <ul style="list-style-type: none"> <li>• 20 minutes is the factory default setting.</li> <li>• Lower settings conserve more energy, but may require longer warm-up times.</li> <li>• Select the lowest setting if the printer shares an electrical circuit with room lighting or you notice lights flickering in the room.</li> <li>• Select a high setting if the printer is in constant use. Under most circumstances, this keeps the printer ready to print with minimum warm-up time.</li> <li>• Disabled appears only if Energy Conserve is set to Off.</li> </ul>
<b>Timeouts</b> Print with Display Off Allow printing with display off Display on when printing	Print a job with the display off. <b>Note:</b> Display on when printing is the factory default setting.
<b>Timeouts</b> Hibernate Timeout Disabled 20 minutes 1–3 hours 6 hours 1–3 days 1–2 weeks 1 month	Set the amount of time before the printer enters Hibernate mode. <b>Note:</b> 3 days is the factory default setting.
<b>Timeouts</b> Hibernate Timeout on Connection Hibernate Do Not Hibernate	Set the printer to Hibernate mode even if there is an active Ethernet connection. <b>Note:</b> Do Not Hibernate is the factory default setting.
<b>Timeouts</b> Screen Timeout 15–300	Set the amount of time the printer waits before returning the display to Ready state. <b>Note:</b> 30 seconds is the factory default setting.
<b>Timeouts</b> Prolong Screen Timeout On Off	Continue a specified job without returning to the home screen when the screen timeout timer expires. <b>Note:</b> Off is the factory default setting.

Use	To
<b>Timeouts</b> Print Timeout Disabled 1–255	Set the amount of time the printer waits to receive an end-of-job message before canceling the rest of the job.  <b>Notes:</b> <ul style="list-style-type: none"> <li>• 90 seconds is the factory default setting.</li> <li>• When the timer expires, any partially printed page still in the printer is printed.</li> <li>• Print Timeout is available only when using PCL emulation.</li> </ul>
<b>Timeouts</b> Wait Timeout Disabled 15–65535	Set the amount of time the printer waits for additional data before canceling a print job.  <b>Notes:</b> <ul style="list-style-type: none"> <li>• 40 seconds is the factory default setting.</li> <li>• Wait Timeout is available only when the printer is using PostScript emulation.</li> </ul>
<b>Timeouts</b> Job Hold Timeout 5–255	Set the amount of time the printer waits for user intervention before it holds jobs that require unavailable resources and continues to print other jobs in the print queue.  <b>Notes:</b> <ul style="list-style-type: none"> <li>• 30 is the factory default setting.</li> <li>• This menu item appears only when a hard disk is installed.</li> </ul>
<b>Error Recovery</b> Auto Reboot Reboot when idle Reboot always Reboot never	Set the printer to restart when an error occurs.  <b>Note:</b> Reboot always is the factory default setting.
<b>Error Recovery</b> Max Auto Reboots 1–20	Determine the number of automatic reboots the printer can perform.  <b>Notes:</b> <ul style="list-style-type: none"> <li>• 2 is the factory default setting.</li> <li>• When the number of reboots equals the specified value, then the error message appears.</li> </ul>
<b>Print Recovery</b> Auto Continue Disabled 5–255	Let the printer automatically continue printing from certain offline situations when not resolved within the specified time period.  <b>Note:</b> Disabled is the factory default setting.

Use	To
<b>Print Recovery</b> Jam Recovery On Off Auto	Specify whether the printer reprints jammed pages. <b>Notes:</b> <ul style="list-style-type: none"> <li>• Auto is the factory default setting. The printer reprints jammed pages unless the memory required to hold the pages is needed for other printer tasks.</li> <li>• On sets the printer to always reprint jammed pages.</li> <li>• Off sets the printer to never reprint jammed pages.</li> </ul>
<b>Print Recovery</b> Page Protect Off On	Successfully print a page that may not have printed otherwise. <b>Notes:</b> <ul style="list-style-type: none"> <li>• Off is the factory default setting. Off prints a partial page when there is not enough memory to print the whole page.</li> <li>• On sets the printer to print the entire page.</li> </ul>
<b>Press Sleep Button</b> Do Nothing Sleep Hibernate	Determine how the printer, while in idle state, reacts to a short press of the Sleep button. <b>Note:</b> Sleep is the factory default setting.
<b>Press and Hold Sleep Button</b> Do Nothing Sleep Hibernate	Determine how the printer, while in idle state, reacts to a long press of the Sleep button. <b>Note:</b> Do Nothing is the factory default setting.
<b>Factory Defaults</b> Do Not Restore Restore Now	Use the printer factory default settings. <b>Notes:</b> <ul style="list-style-type: none"> <li>• Do Not Restore is the factory default setting.</li> <li>• Restore Now returns all printer settings to the factory default settings except Network/Ports menu settings. All downloads stored in the RAM are deleted. Downloads stored in the flash memory or in a hard disk are not affected.</li> </ul>
<b>Export Configuration File</b> Export	Export configuration files to a flash drive.

## Copy Settings menu

Use	To
<b>Content Type</b> Text Graphics Text/Photo Photo	Specify the content of the original document. <b>Note:</b> Text/Photo is the factory default setting.



Use	To
<b>Content Source</b> Black/White Laser Color Laser Inkjet Photo/Film Magazine Newspaper Press Other	Specify how the original document was produced. <b>Note:</b> Color Laser is the factory default setting.
<b>Color</b> Auto On Off	Specify whether copies are printed in color. <b>Note:</b> On is the factory default setting.
<b>Auto Color Detect</b> Color Sensitivity 1–9 Area Sensitivity 1–9	Set the amount of color the printer can detect from the original document. <b>Note:</b> This menu item is applicable only when Color is set to Auto.
<b>Allow color copies</b> On Off	Enable color in copies. <b>Notes:</b> <ul style="list-style-type: none"> <li>• On is the factory default setting.</li> <li>• Setting this to Off hides all color-specific menus.</li> <li>• This setting overrides the Color setting.</li> </ul>
<b>Sides (Duplex)</b> 1 sided to 1 sided 1 sided to 2 sided 2 sided to 1 sided 2 sided to 2 sided	Specify whether an original document is two-sided or one-sided, and then specify whether the copy should be two-sided or one-sided. <b>Note:</b> 1 sided to 1 sided is the factory default setting. This setting is selected when using a one-sided original document for a one-sided copy job.
<b>Paper Saver</b> Off 2-up Portrait 2-up Landscape 4-up Portrait 4-up Landscape	Copy two or four sheets of a document on one page. <b>Note:</b> Off is the factory default setting.
<b>Print Page Borders</b> On Off	Specify whether a border is printed. <b>Note:</b> Off is the factory default setting.
<b>Collate</b> (1,1,1) (2,2,2) (1,2,3) (1,2,3)	Stack the pages of a print job in sequence when printing multiple copies. <b>Note:</b> (1,2,3) (1,2,3) is the factory default setting.

Use	To
<p><b>Original Size</b></p> <ul style="list-style-type: none"> <li>Letter</li> <li>Legal</li> <li>Executive</li> <li>Folio</li> <li>Statement</li> <li>Oficio (Mexico)</li> <li>Universal</li> <li>Auto Size Sense</li> <li>Mixed Sizes</li> <li>A4</li> <li>A5</li> <li>A6</li> <li>JIS B5</li> <li>Custom Scan Size [x]</li> <li>Book Original</li> <li>Business Card</li> <li>3 x 5 in.</li> <li>4 x 6 in.</li> <li>ID Card</li> </ul>	<p>Specify the size of the original document.</p> <p><b>Notes:</b></p> <ul style="list-style-type: none"> <li>• Letter is the U.S. factory default setting. A4 is the international factory default setting.</li> <li>• Legal, Folio, and Oficio (Mexico) paper sizes are supported only in the ADF.</li> </ul>
<p><b>Copy To Source</b></p> <ul style="list-style-type: none"> <li>Tray [x]</li> <li>Manual Feeder</li> <li>Multipurpose Feeder</li> </ul>	<p>Specify the paper source for copy jobs.</p> <p><b>Note:</b> Tray 1 is the factory default setting.</p>
<p><b>Transparency Separators</b></p> <ul style="list-style-type: none"> <li>On</li> <li>Off</li> </ul>	<p>Place a sheet of paper between transparencies.</p> <p><b>Note:</b> On is the factory default setting.</p>
<p><b>Separator Sheets</b></p> <ul style="list-style-type: none"> <li>Off</li> <li>Between Copies</li> <li>Between Jobs</li> <li>Between Pages</li> </ul>	<p>Place a sheet of paper between pages, copies, or jobs.</p> <p><b>Note:</b> Off is the factory default setting.</p>
<p><b>Separator Sheet Source</b></p> <ul style="list-style-type: none"> <li>Tray [x]</li> <li>Multipurpose Feeder</li> </ul>	<p>Specify the paper source for the separator sheet.</p> <p><b>Note:</b> Tray 1 is the factory default setting.</p>
<p><b>Darkness</b></p> <ul style="list-style-type: none"> <li>1–9</li> </ul>	<p>Lighten or darken the output.</p> <p><b>Note:</b> 5 is the factory default setting.</p>
<p><b>Number of Copies</b></p> <ul style="list-style-type: none"> <li>1–9999</li> </ul>	<p>Specify the number of copies for the copy job.</p> <p><b>Note:</b> 1 is the factory default setting.</p>

Use	To
<p><b>Header/Footer</b>                      [Location]                      Off                      Date/Time                      Page number                      Custom text                      Print on                      All pages                      First page only                      All but first page                      Custom text</p>	<p>Specify header and footer information and its location on the page.                      Select from the following location options:</p> <ul style="list-style-type: none"> <li>• Top left</li> <li>• Top middle</li> <li>• Top right</li> <li>• Bottom left</li> <li>• Bottom middle</li> <li>• Bottom right</li> </ul> <p><b>Notes:</b></p> <ul style="list-style-type: none"> <li>• Off is the factory default setting for the location.</li> <li>• All pages is the factory default setting for Print on.</li> </ul>
<p><b>Overlay</b>                      Confidential                      Copy                      Draft                      Urgent                      Custom                      Off</p>	<p>Specify the overlay text printed on each page of the copy job.  <b>Note:</b> Off is the factory default setting.</p>
<p><b>Custom Overlay</b></p>	<p>Specify the custom overlay text.</p>
<p><b>Allow priority copies</b>                      On                      Off</p>	<p>Allow interruption of a print job to copy a page or document.  <b>Note:</b> On is the factory default setting.</p>
<p><b>Custom Job scanning</b>                      On                      Off</p>	<p>Scan a document that contains mixed paper sizes into a single copy job.  <b>Notes:</b></p> <ul style="list-style-type: none"> <li>• Off is the factory default setting.</li> <li>• This menu item appears only when a formatted, working hard disk is installed.</li> </ul>
<p><b>Allow Save as Shortcut</b>                      On                      Off</p>	<p>Save custom copy settings as shortcuts.  <b>Note:</b> On is the factory default setting.</p>
<p><b>Background Removal</b>                      -4 to 4</p>	<p>Adjust the amount of background visible on a copy.  <b>Note:</b> 0 is the factory default setting.</p>
<p><b>Auto Center</b>                      Off                      On</p>	<p>Automatically align the content at the center of the page.  <b>Note:</b> Off is the factory default setting.</p>
<p><b>Color Balance</b>                      Cyan - Red                      Magenta - Green                      Yellow - Blue</p>	<p>Enable an equal balance of colors in the output.</p>

Use	To
<p><b>Color Dropout</b></p> <ul style="list-style-type: none"> <li>Color Dropout               <ul style="list-style-type: none"> <li>None</li> <li>Red</li> <li>Green</li> <li>Blue</li> </ul> </li> <li>Default Red Threshold               <ul style="list-style-type: none"> <li>0–255</li> </ul> </li> <li>Default Green Threshold               <ul style="list-style-type: none"> <li>0–255</li> </ul> </li> <li>Default Blue Threshold               <ul style="list-style-type: none"> <li>0–255</li> </ul> </li> </ul>	<p>Specify which color to drop and to adjust the dropout setting for each color threshold.</p> <p><b>Notes:</b></p> <ul style="list-style-type: none"> <li>None is the factory default setting for Color Dropout.</li> <li>128 is the factory default setting for each color threshold.</li> </ul>
<p><b>Contrast</b></p> <ul style="list-style-type: none"> <li>0–5</li> <li>Best for content</li> </ul>	<p>Specify the contrast of the output.</p> <p><b>Note:</b> Best for content is the factory default setting.</p>
<p><b>Mirror Image</b></p> <ul style="list-style-type: none"> <li>Off</li> <li>On</li> </ul>	<p>Create a mirror image of the original document.</p> <p><b>Note:</b> Off is the factory default setting.</p>
<p><b>Negative Image</b></p> <ul style="list-style-type: none"> <li>Off</li> <li>On</li> </ul>	<p>Create a negative image of the original document.</p> <p><b>Note:</b> Off is the factory default setting.</p>
<p><b>Shadow Detail</b></p> <ul style="list-style-type: none"> <li>-4 to 4</li> </ul>	<p>Adjust the amount of shadow detail visible on a copy.</p> <p><b>Note:</b> 0 is the factory default setting.</p>
<p><b>Adjust ADF Skew</b></p> <ul style="list-style-type: none"> <li>Auto</li> <li>Off</li> <li>On</li> </ul>	<p>Correct the slight skew in the scanned image.</p> <p><b>Note:</b> Auto is the factory default setting.</p>
<p><b>Scan edge to edge</b></p> <ul style="list-style-type: none"> <li>Off</li> <li>On</li> </ul>	<p>Specify if the original document is scanned edge-to-edge.</p> <p><b>Note:</b> Off is the factory default setting.</p>
<p><b>Sharpness</b></p> <ul style="list-style-type: none"> <li>1–5</li> </ul>	<p>Adjust the amount of sharpness of a copy.</p> <p><b>Note:</b> 3 is the factory default setting.</p>
<p><b>Temperature</b></p> <ul style="list-style-type: none"> <li>-4 to 4</li> </ul>	<p>Specify warm or cool outputs. Cool values generate a bluer output than the default while warm values generate a redder output than the default.</p> <p><b>Note:</b> 0 is the factory default setting.</p>
<p><b>Sample Copy</b></p> <ul style="list-style-type: none"> <li>Off</li> <li>On</li> </ul>	<p>Create a sample copy of the original document.</p> <p><b>Note:</b> Off is the factory default setting.</p>

## Fax Settings menu

### Fax Mode (Analog Fax Setup) menu

Analog Fax Setup mode sends the fax job through a telephone line.

#### General Fax Settings

Use	To
<b>Restore Factory Defaults</b>	Restore the factory defaults of all fax settings.
<b>Optimize Fax Compatibility</b>	Optimize fax compatibility with other fax machines.
<b>Fax Name</b>	Specify the name of the fax in the printer.
<b>Fax Number</b>	Specify the telephone number assigned to the fax.
<b>Fax ID</b> Fax Name Fax Number	Specify how the fax is identified. <b>Note:</b> Fax Number is the factory default setting.
<b>Enable Manual Fax</b> On Off	Set the printer to fax manually, which requires a line splitter and a telephone handset. <b>Notes:</b> <ul style="list-style-type: none"> <li>Off is the factory default setting.</li> <li>Use a regular telephone to answer an incoming fax job and to dial a fax number.</li> <li>Press # 0 on the numeric keypad to go directly to the Manual Fax function.</li> </ul>
<b>Memory Use</b> All receive Mostly receive Equal Mostly send All send	Define the allocation of non-volatile memory between sending and receiving fax jobs. <b>Note:</b> Equal is the factory default setting.
<b>Cancel Faxes</b> Allow Don't Allow	Specify whether canceling of fax jobs is allowed. <b>Note:</b> Allow is the factory default setting.
<b>Caller ID</b> Off Primary Alternate	Specify the type of caller ID being used.
<b>Fax number masking</b> Off From left From right	Specify the direction from where digits are masked in an outgoing fax number. <b>Notes:</b> <ul style="list-style-type: none"> <li>Off is the factory default setting.</li> <li>The number of characters masked is determined by the Digits to Mask setting.</li> </ul>
<b>Digits to Mask</b> 0–58	Specify the number of digits to mask in an outgoing fax number. <b>Note:</b> 0 is the factory default setting.

Use	To
<p><b>Fax Cover Page</b></p> <ul style="list-style-type: none"> <li>Fax Cover Page                             <ul style="list-style-type: none"> <li>Off by default</li> <li>On by default</li> <li>Never use</li> <li>Always use</li> </ul> </li> <li>Include to Field                             <ul style="list-style-type: none"> <li>On</li> <li>Off</li> </ul> </li> <li>Include from Field                             <ul style="list-style-type: none"> <li>On</li> <li>Off</li> </ul> </li> <li>From                             <ul style="list-style-type: none"> <li>Include Message Field                                     <ul style="list-style-type: none"> <li>On</li> <li>Off</li> </ul> </li> </ul> </li> <li>Message                             <ul style="list-style-type: none"> <li>Include Logo                                     <ul style="list-style-type: none"> <li>On</li> <li>Off</li> </ul> </li> </ul> </li> <li>Include Footer [x]                             <ul style="list-style-type: none"> <li>On</li> <li>Off</li> </ul> </li> <li>Footer [x]</li> </ul>	<p>Configure the fax cover page.</p> <p><b>Notes:</b></p> <ul style="list-style-type: none"> <li>Off by default is the factory default setting for Fax Cover Page.</li> <li>Off is the factory default setting for all other menu items.</li> </ul>

**Fax Send Settings**

Use	To
<p><b>Resolution</b></p> <ul style="list-style-type: none"> <li>Standard</li> <li>Fine 200 dpi</li> <li>Super Fine 300 dpi</li> <li>Ultra Fine 600 dpi</li> </ul>	<p>Specify quality in dots per inch (dpi). A higher resolution gives better print quality, but increases the fax transmission time for outgoing faxes.</p> <p><b>Note:</b> Standard is the factory default setting.</p>

Use	To
<p><b>Original Size</b></p> <ul style="list-style-type: none"> <li>Letter</li> <li>Legal</li> <li>Executive</li> <li>Folio</li> <li>Statement</li> <li>Oficio (Mexico)</li> <li>Universal</li> <li>Auto Size Sense</li> <li>Mixed Sizes</li> <li>A4</li> <li>A5</li> <li>A6</li> <li>JIS B5</li> <li>Custom Scan Size [x]</li> <li>Book Original</li> <li>Business Card</li> <li>3 x 5 in.</li> <li>4 x 6 in.</li> </ul>	<p>Specify the size of the original document.</p> <p><b>Note:</b> Mixed Sizes is the U.S. factory default setting. A4 is the international factory default setting.</p>
<p><b>Sides (Duplex)</b></p> <ul style="list-style-type: none"> <li>Off</li> <li>Long edge</li> <li>Short edge</li> </ul>	<p>Specify the orientation of the original documents loaded in the ADF for two-sided scanning.</p> <p><b>Note:</b> Off is the factory default setting.</p>
<p><b>Content Type</b></p> <ul style="list-style-type: none"> <li>Text</li> <li>Graphics</li> <li>Text/Photo</li> <li>Photo</li> </ul>	<p>Specify the content of the original document.</p> <p><b>Note:</b> Text is the factory default setting.</p>
<p><b>Content Source</b></p> <ul style="list-style-type: none"> <li>Black/White Laser</li> <li>Color Laser</li> <li>Inkjet</li> <li>Photo/Film</li> <li>Magazine</li> <li>Newspaper</li> <li>Press</li> <li>Other</li> </ul>	<p>Specify how the original document was produced.</p> <p><b>Note:</b> Color Laser is the factory default setting.</p>
<p><b>Darkness</b></p> <ul style="list-style-type: none"> <li>1–9</li> </ul>	<p>Lighten or darken the output.</p> <p><b>Note:</b> 5 is the factory default setting.</p>
<p><b>Dial Prefix</b></p>	<p>Enter a dialing prefix, such as 99. A numeric entry field is provided.</p>
<p><b>Dialing Prefix Rules</b></p> <ul style="list-style-type: none"> <li>Prefix Rule [x]</li> </ul>	<p>Establish a dialing prefix rule.</p>

Use	To
<b>Automatic Redial</b> 0–9	Specify the number of times the printer tries to send the fax to a specified number. <b>Note:</b> 5 is the factory default setting.
<b>Redial frequency</b> 1–200	Specify the number of minutes between redials. <b>Note:</b> 3 is the factory default setting.
<b>Behind a PABX</b> Yes No	Enable or disable switchboard blind dialing without a dial tone. <b>Note:</b> No is the factory default setting.
<b>Enable ECM</b> Yes No	Enable or disable Error Correction Mode for fax jobs. <b>Note:</b> Yes is the factory default setting.
<b>Enable Fax Scans</b> On Off	Fax files that are scanned at the printer. <b>Note:</b> On is the factory default setting.
<b>Driver to fax</b> Yes No	Allow the print driver to send fax jobs. <b>Note:</b> Yes is the factory default setting.
<b>Allow Save as Shortcut</b> On Off	Save fax numbers as shortcuts in the printer. <b>Note:</b> On is the factory default setting.
<b>Dial Mode</b> Tone Pulse	Specify the dialing sound. <b>Note:</b> Tone is the factory default setting.
<b>Max Speed</b> 2400 4800 9600 14400 33600	Specify the maximum speed in baud at which faxes are sent. <b>Note:</b> 33600 is the factory default setting.
<b>Custom Job scanning</b> On Off	Scan a document that contains mixed paper sizes into a single file. <b>Notes:</b> <ul style="list-style-type: none"> <li>• Off is the factory default setting.</li> <li>• This menu item appears only when a formatted, working printer hard disk is installed.</li> </ul>
<b>Scan Preview</b> On Off	Show whether a preview appears on the display for scan jobs. <b>Notes:</b> <ul style="list-style-type: none"> <li>• Off is the factory default setting.</li> <li>• This menu item appears only when a formatted, working printer hard disk is installed.</li> </ul>
<b>Background Removal</b> -4 to 4	Adjust the amount of background visible on a scanned image. <b>Note:</b> 0 is the factory default setting.



Use	To
<b>Color Balance</b> Cyan - Red Magenta - Green Yellow - Blue	Enable an equal balance of colors in the scanned image.
<b>Color Dropout</b> Color Dropout None Red Green Blue Default Red Threshold 0–255 Default Green Threshold 0–255 Default Blue Threshold 0–255	Specify which color to drop and to adjust the dropout setting for each color threshold.  <b>Notes:</b> <ul style="list-style-type: none"> <li>• None is the factory default setting for Color Dropout.</li> <li>• 128 is the factory default setting for each color threshold.</li> </ul>
<b>Contrast</b> 0–5 Best for content	Specify the contrast in the scanned image.  <b>Note:</b> Best for content is the factory default setting.
<b>Mirror Image</b> Off On	Create a mirror image of the original document.  <b>Note:</b> Off is the factory default setting.
<b>Negative Image</b> Off On	Create a negative image of the original document.  <b>Note:</b> Off is the factory default setting.
<b>Shadow Detail</b> -4 to 4	Adjust the amount of shadow detail visible.  <b>Note:</b> 0 is the factory default setting.
<b>Adjust ADF Skew</b> Auto Off On	Correct slight skew in the scanned image.  <b>Note:</b> Auto is the factory default setting.
<b>Scan edge to edge</b> Off On	Specify whether the original document is scanned edge-to-edge.  <b>Note:</b> Off is the factory default setting.
<b>Sharpness</b> 1–5	Adjust the sharpness of a fax.  <b>Note:</b> 3 is the factory default setting.
<b>Temperature</b> -4 to 4	Specify warm or cool outputs. Cool values generate a bluer output than the default while warm values generate a redder output than the default.  <b>Note:</b> 0 is the factory default setting.

Use	To
<b>Enable Color Fax Scans</b> Off by default On by default Never use Always use	Enable color faxing. <b>Note:</b> Off by default is the factory default setting.
<b>Auto Convert Color Faxes to Mono Faxes</b> On Off	Convert all outgoing faxes to black and white. <b>Note:</b> On is the factory default setting.

### Fax Receive Settings

Use	To
<b>Enable Fax Receive</b> On Off	Allow the printer to receive fax jobs. <b>Note:</b> On is the factory default setting.
<b>Caller ID</b> On Off	Display the caller ID information of an incoming fax. <b>Note:</b> On is the factory default setting.
<b>Fax Job Waiting</b> None Toner Toner and Supplies	Remove fax jobs from the print queue when the job requires specific unavailable resources. <b>Note:</b> None is the factory default setting.
<b>Rings to Answer</b> 1–25	Specify the number of rings before answering an incoming fax job. <b>Note:</b> 3 is the factory default setting.
<b>Auto Answer</b> Yes No	Set the printer to receive faxes automatically. <b>Note:</b> Yes is the factory default setting.
<b>Manual Answer Code</b> 0–9	Manually enter a code on the telephone number pad to begin receiving a fax. <b>Notes:</b> <ul style="list-style-type: none"> <li>• 9 is the factory default setting.</li> <li>• This menu item is used when the printer shares a line with a telephone.</li> </ul>
<b>Auto Reduction</b> On Off	Scale an incoming fax job so that it fits the size of the paper loaded in the designated fax source. <b>Note:</b> On is the factory default setting.
<b>Paper Source</b> Auto Tray [x] Multipurpose Feeder Manual Feeder	Specify the paper source for printing incoming fax jobs. <b>Note:</b> Auto is the factory default setting.

Use	To
<b>Sides (Duplex)</b> Off On	Enable two-sided printing for incoming fax jobs. <b>Note:</b> Off is the factory default setting.
<b>Separator Sheets</b> Off Before Job After Job	Enable the printer to include separator sheets for incoming fax jobs. <b>Note:</b> Off is the factory default setting.
<b>Separator Sheet Source</b> Tray [x] Multipurpose Feeder	Specify the paper source for the separator sheet. <b>Note:</b> Tray 1 is the factory default setting.
<b>Fax Footer</b> On Off	Print the transmission information at the bottom of each page from a received fax. <b>Note:</b> Off is the factory default setting.
<b>Max Speed</b> 2400 4800 9600 14400 33600	Specify the maximum speed in baud at which faxes are received. <b>Note:</b> 33600 is the factory default setting.
<b>Fax Forwarding</b> Print Print and Forward Forward	Enable forwarding of received faxes to another recipient. <b>Note:</b> Print is the factory default setting.
<b>Forward to</b> Fax E-mail FTP LDSS eSF	Specify the type of recipient to which faxes are forwarded. <b>Notes:</b> <ul style="list-style-type: none"> <li>• Fax is the factory default setting.</li> <li>• This menu item is available only from the printer Embedded Web Server.</li> </ul>
<b>Forward to Shortcut</b>	Enter the shortcut number which matches the recipient type (Fax, E-mail, FTP, LDSS, or eSF).
<b>Block No Name Fax</b> Off On	Enable blocking of incoming faxes sent from devices with no station ID or fax ID specified. <b>Note:</b> Off is the factory default setting.
<b>Banned Fax List</b>	Enable the list of blocked fax numbers stored in the printer.
<b>Holding Faxes</b> Held Fax Mode Off Always On Manual Scheduled Fax Holding Schedule	Enable the printer to hold received faxes from printing until they are released. Held faxes can be released manually or at a scheduled day or time. <b>Note:</b> Off is the factory default setting.

Use	To
<b>Enable Color Fax Receive</b> On Off	Enable the printer to receive fax in color and print it in grayscale. <b>Note:</b> On is the factory default setting.

### Fax Log Settings

Use	To
<b>Transmission Log</b> Print log Do not print log Print only for error	Enable printing of a transmission log after each fax job. <b>Note:</b> Print log is the factory default setting.
<b>Receive Error Log</b> Print Never Print on Error	Enable printing of a receive error log. <b>Note:</b> Print Never is the factory default setting.
<b>Auto Print Logs</b> On Off	Enable automatic printing of fax logs. <b>Notes:</b> <ul style="list-style-type: none"> <li>• On is the factory default setting.</li> <li>• Logs print after every 200 fax jobs.</li> </ul>
<b>Log Paper Source</b> Tray [x] Multipurpose Feeder	Specify the source of the paper used for printing logs. <b>Note:</b> Tray 1 is the factory default setting.
<b>Logs Display</b> Remote Station Name Dialed Number	Specify whether printed logs display the dialed number or the station name or fax name returned. <b>Note:</b> Remote Station Name is the factory default setting.
<b>Enable Job Log</b> On Off	Enable access to the Fax Job log. <b>Note:</b> On is the factory default setting.
<b>Enable Call Log</b> On Off	Enable access to the Fax Call log. <b>Note:</b> On is the factory default setting.

### Speaker Settings

Use	To
<b>Speaker Mode</b> Always Off On until Connected Always On	Specify the mode of the speaker. <b>Note:</b> On until Connected is the factory default setting. A sound is issued until the fax connection is made.
<b>Speaker Volume</b> High Low	Set the speaker volume to high or low. <b>Note:</b> High is the factory default setting.

Use	To
<b>Ringer Volume</b> Off On	Enable or disable the ringer volume. <b>Note:</b> On is the factory default setting.

**Answer On**

Use	To
All Rings Single Ring Only Double Ring Only Triple Ring Only Single or Double Rings Only Single or Triple Rings Only Double or Triple Rings Only	Specify ring patterns when the printer is answering calls. <b>Note:</b> All Rings is the factory default setting.

**Fax Mode (Fax Server Setup) menu**

Fax Mode sends the fax job to a fax server for transmission.

Use	To
<b>To Format</b> <b>Reply Address</b> <b>Subject</b> <b>Message</b>	Enter specific fax information using the control panel.
<b>SMTP Setup</b>	
<b>Primary SMTP Gateway</b> <b>Secondary SMTP Gateway</b>	
<b>Image Format</b> PDF (.pdf) XPS (.xps) TIFF (.tif)	
<b>Content Type</b> Text Graphics Text/Photo Photo	Specify the image format. <b>Note:</b> PDF (.pdf) is the factory default setting. Specify the content of the original document. <b>Note:</b> Text/Photo is the factory default setting.

Use	To
<b>Content Source</b> Black/White Laser Color Laser Inkjet Photo/Film Magazine Newspaper Press Other	Specify how the content was originally produced. <b>Note:</b> Color Laser is the factory default setting.
<b>Fax Resolution</b> Standard Fine 200 dpi Super Fine 300 dpi Ultra Fine 600 dpi	Specify quality in dots per inch (dpi). <b>Note:</b> Standard is the factory default setting.
<b>Darkness</b> 1–9	Lighten or darken the output. <b>Note:</b> 5 is the factory default setting.
<b>Orientation</b> Portrait Landscape	Specify the orientation of the scanned image. <b>Note:</b> Portrait is the factory default setting.
<b>Original Size</b> Letter Legal Executive Folio Statement Oficio (Mexico) Universal Auto Size Sense Mixed Sizes A4 A5 A6 JIS B5 Custom Scan Size [x] Book Original Business Card 4 x 6 in. 3 x 5 in.	Specify the size of the original document. <b>Note:</b> Mixed Sizes is the U.S. factory default setting. A4 is the international factory default setting.
<b>Use Multi-Page TIFF</b> On Off	Provide a choice between single-page TIFF files and multiple-page TIFF files. For a multiple-page scan-to-fax job, either one TIFF file is created containing all the pages, or multiple TIFF files are created with one file for each page of the scan job. <b>Note:</b> On is the factory default setting.

Use	To
<b>Enable Analog Receive</b> Off On	Enable receiving of analog faxes. <b>Note:</b> Off is the factory default setting.

## E-mail Settings menu

Use	To
<b>E-mail Server Setup</b> Subject Message File Name	Specify e-mail server information.
<b>E-mail Server Setup</b> Send me a copy Never appears On by default Off by default Always On	Send a copy of the e-mail to the sender. <b>Note:</b> Never appears is the factory default setting.
<b>E-mail Server Setup</b> Max E-mail size 0–65535 KB	Specify the maximum e-mail size. <b>Note:</b> E-mails bigger than the specified maximum size are not sent.
<b>E-mail Server Setup</b> Size Error Message	Send a message when an e-mail is greater than the configured size limit.
<b>E-mail Server Setup</b> Limit destinations	Specify a domain name, such as a company domain name, and then limit e-mail destinations only to that domain name. <b>Notes:</b> <ul style="list-style-type: none"> <li>• E-mail can be sent only to the specified domain.</li> <li>• The limit is one domain.</li> </ul>
<b>E-mail Server Setup</b> Web Link Setup Server Login Password Path File Name Web Link	Define the e-mail server Web link settings. <b>Note:</b> The characters * : ? < >   are invalid entries for a path name.
<b>Format</b> PDF (.pdf) TIFF (.tif) JPEG (.jpg) XPS (.xps) RTF (.rtf) TXT (.txt)	Specify the file format. <b>Note:</b> PDF (.pdf) is the factory default setting.

Use	To
<p><b>PDF Settings</b></p> <p>PDF Version 1.2–1.7 A–1a A–1b</p> <p>PDF Compression Normal High</p> <p>Secure PDF Off On</p> <p>Searchable PDF Off On</p>	<p>Configure the PDF settings.</p> <p><b>Notes:</b></p> <ul style="list-style-type: none"> <li>• 1.5 is the factory default setting for PDF Version.</li> <li>• Normal is the factory default setting for PDF Compression. This menu item appears only when a formatted, working hard disk is installed.</li> <li>• Off is the factory default setting for Secure PDF and Searchable PDF. Secure PDF requires you to enter your password twice.</li> </ul>
<p><b>Content Type</b></p> <p>Text Graphics Text/Photo Photo</p>	<p>Specify the content of the original document.</p> <p><b>Note:</b> Text/Photo is the factory default setting.</p>
<p><b>Content Source</b></p> <p>Black/White Laser Color Laser Inkjet Photo/Film Magazine Newspaper Press Other</p>	<p>Specify how the original document was produced.</p> <p><b>Note:</b> Color Laser is the factory default setting.</p>
<p><b>Color</b></p> <p>Off On</p>	<p>Specify whether the printer captures and transmits content in color.</p> <p><b>Note:</b> On is the factory default setting.</p>
<p><b>Resolution</b></p> <p>75 dpi 150 dpi 200 dpi 300 dpi 400 dpi 600 dpi</p>	<p>Specify the resolution of the scan in dots per inch.</p> <p><b>Note:</b> 150 dpi is the factory default setting.</p>
<p><b>Darkness</b></p> <p>1–9</p>	<p>Lighten or darken the output.</p> <p><b>Note:</b> 5 is the factory default setting.</p>
<p><b>Orientation</b></p> <p>Portrait Landscape</p>	<p>Specify the orientation of the scanned image.</p> <p><b>Note:</b> Portrait is the factory default setting.</p>



Use	To
<p><b>Original Size</b></p> <ul style="list-style-type: none"> <li>Letter</li> <li>Legal</li> <li>Executive</li> <li>Folio</li> <li>Statement</li> <li>Oficio (Mexico)</li> <li>Universal</li> <li>Auto Size Sense</li> <li>Mixed Sizes</li> <li>A4</li> <li>A5</li> <li>A6</li> <li>JIS B5</li> <li>Custom Scan Size [x]</li> <li>Book Original</li> <li>Business Card</li> <li>3 x 5 in.</li> <li>4 x 6 in.</li> </ul>	<p>Specify the size of the original document.</p> <p><b>Note:</b> Letter is the U.S. factory default setting. A4 is the international factory default setting.</p>
<p><b>Sides (Duplex)</b></p> <ul style="list-style-type: none"> <li>Off</li> <li>Long Edge</li> <li>Short Edge</li> </ul>	<p>Specify the orientation of the original document loaded in the ADF for two-sided scanning.</p> <p><b>Note:</b> Off is the factory default setting.</p>
<p><b>JPEG Quality</b></p> <ul style="list-style-type: none"> <li>Best for content</li> <li>5–90</li> </ul>	<p>Set the quality of a JPEG photo image in relation to file size and quality of the image.</p> <p><b>Note:</b> Best for content is the factory default setting.</p>
<p><b>Text Default</b></p> <ul style="list-style-type: none"> <li>5–90</li> </ul>	<p>Set the quality of a text image in relation to file size and quality of the image.</p> <p><b>Note:</b> 75 is the factory default setting.</p>
<p><b>Text/Photo Default</b></p> <ul style="list-style-type: none"> <li>5–90</li> </ul>	<p>Set the quality of a text or photo image in relation to file size and the quality of the image.</p> <p><b>Note:</b> 75 is the factory default setting.</p>
<p><b>Photo Default</b></p> <ul style="list-style-type: none"> <li>5–90</li> </ul>	<p>Set the quality of a photo image in relation to file size and the quality of the image.</p> <p><b>Note:</b> 50 is the factory default setting.</p>
<p><b>E-mail images sent as</b></p> <ul style="list-style-type: none"> <li>Attachment</li> <li>Web Link</li> </ul>	<p>Specify how the images are sent.</p> <p><b>Note:</b> Attachment is the factory default setting.</p>
<p><b>Use Multi-Page TIFF</b></p> <ul style="list-style-type: none"> <li>On</li> <li>Off</li> </ul>	<p>Provide a choice between single-page TIFF files and multiple-page TIFF files. For a multiple-page scan-to-e-mail job, either one TIFF file is created containing all the pages, or multiple TIFF files are created with one file for each page of the job.</p> <p><b>Note:</b> On is the factory default setting.</p>

Use	To
<b>TIFF Compression</b> LZW JPEG	Specify the format used in compressing TIFF files. <b>Note:</b> LZW is the factory default setting.
<b>Transmission Log</b> Print log Do not print log Print only for error	Specify whether to print the transmission log. <b>Note:</b> Print log is the factory default setting.
<b>Log Paper Source</b> Tray [x] Multipurpose Feeder	Specify the paper source for printing e-mail logs. <b>Note:</b> Tray 1 is the factory default setting.
<b>E-mail Bit Depth</b> 1 bit 8 bit	Enable the Text/Photo mode to produce smaller file sizes by using 1-bit images when Color is set to Off. <b>Note:</b> 8 bit is the factory default setting.
<b>Custom Job scanning</b> On Off	Copy a document that contains mixed paper sizes. <b>Notes:</b> <ul style="list-style-type: none"> <li>• Off is the factory default setting.</li> <li>• This menu item appears only when a formatted, working printer hard disk is installed.</li> </ul>
<b>Scan Preview</b> On Off	Specify whether a preview appears on the display for scan jobs. <b>Notes:</b> <ul style="list-style-type: none"> <li>• Off is the factory default setting.</li> <li>• This menu item appears only when a formatted, working printer hard disk is installed.</li> </ul>
<b>Allow Save as Shortcut</b> On Off	Save e-mail addresses as shortcuts. <b>Notes:</b> <ul style="list-style-type: none"> <li>• On is the factory default setting.</li> <li>• When set to Off, the Save As Shortcut button does not appear on the e-mail Destination screen.</li> </ul>
<b>Background Removal</b> -4 to 4	Adjust the amount of background visible on a scanned image. <b>Note:</b> 0 is the factory default setting.
<b>Color Balance</b> Cyan - Red Magenta - Green Yellow - Blue	Enable an equal balance of colors in the output.

Use	To
<p><b>Color Dropout</b></p> <ul style="list-style-type: none"> <li>Color Dropout               <ul style="list-style-type: none"> <li>None</li> <li>Red</li> <li>Green</li> <li>Blue</li> </ul> </li> <li>Default Red Threshold               <ul style="list-style-type: none"> <li>0–255</li> </ul> </li> <li>Default Green Threshold               <ul style="list-style-type: none"> <li>0–255</li> </ul> </li> <li>Default Blue Threshold               <ul style="list-style-type: none"> <li>0–255</li> </ul> </li> </ul>	<p>Specify which color to drop and to adjust the dropout setting for each color threshold.</p> <p><b>Notes:</b></p> <ul style="list-style-type: none"> <li>• None is the factory default setting for Color Dropout.</li> <li>• 128 is the factory default setting for each color threshold.</li> </ul>
<p><b>Contrast</b></p> <ul style="list-style-type: none"> <li>0–5</li> <li>Best for content</li> </ul>	<p>Specify the contrast of the output.</p> <p><b>Note:</b> Best for content is the factory default setting.</p>
<p><b>Mirror Image</b></p> <ul style="list-style-type: none"> <li>Off</li> <li>On</li> </ul>	<p>Create a mirror image of the original document.</p> <p><b>Note:</b> Off is the factory default setting.</p>
<p><b>Negative Image</b></p> <ul style="list-style-type: none"> <li>Off</li> <li>On</li> </ul>	<p>Create a negative image of the original document.</p> <p><b>Note:</b> Off is the factory default setting.</p>
<p><b>Shadow Detail</b></p> <ul style="list-style-type: none"> <li>-4 to 4</li> </ul>	<p>Adjust the amount of shadow detail visible on a scanned image.</p> <p><b>Note:</b> 0 is the factory default setting.</p>
<p><b>Adjust ADF Skew</b></p> <ul style="list-style-type: none"> <li>Auto</li> <li>Off</li> <li>On</li> </ul>	<p>Correct slight skew in the scanned image.</p> <p><b>Note:</b> Auto is the factory default setting.</p>
<p><b>Scan edge to edge</b></p> <ul style="list-style-type: none"> <li>Off</li> <li>On</li> </ul>	<p>Specify whether the original document is scanned edge-to-edge.</p> <p><b>Note:</b> Off is the factory default setting.</p>
<p><b>Sharpness</b></p> <ul style="list-style-type: none"> <li>1–5</li> </ul>	<p>Adjust the amount of sharpness on a scanned image.</p> <p><b>Note:</b> 3 is the factory default setting.</p>
<p><b>Temperature</b></p> <ul style="list-style-type: none"> <li>-4 to 4</li> </ul>	<p>Specify warm or cool outputs. Cool values generate a bluer output than the default while warm values generate a redder output than the default.</p> <p><b>Note:</b> 0 is the factory default setting.</p>
<p><b>Use cc:/bcc:</b></p> <ul style="list-style-type: none"> <li>Off</li> <li>On</li> </ul>	<p>Enable the use of the cc: and bcc: fields.</p> <p><b>Note:</b> Off is the factory default setting.</p>

## FTP Settings menu

Use	To
<b>Format</b> PDF (.pdf) TIFF (.tif) JPEG (.jpg) XPS (.xps) RTF (.rtf) TXT (.txt)	Specify the file format. <b>Note:</b> PDF (.pdf) is the factory default setting.
<b>PDF Settings</b> PDF Version 1.2–1.7 A–1a A–1b PDF Compression Normal High Secure PDF Off On Searchable PDF Off On	Configure the PDF settings. <b>Notes:</b> <ul style="list-style-type: none"> <li>• 1.5 is the factory default setting for PDF Version.</li> <li>• Normal is the factory default setting for PDF Compression. This menu item appears only when a formatted, working hard disk is installed.</li> <li>• Off is the factory default setting for Secure PDF and Searchable PDF. Secure PDF requires you to enter your password twice.</li> </ul>
<b>Content Type</b> Text Graphics Text/Photo Photo	Specify the content of the original document. <b>Note:</b> Text/Photo is the factory default setting.
<b>Content Source</b> Black/White Laser Color Laser Inkjet Photo/Film Magazine Newspaper Press Other	Specify how the original document was produced. <b>Note:</b> Color Laser is the factory default setting.
<b>Color</b> Off On	Specify whether the printer captures and transmits content in color. <b>Note:</b> On is the factory default setting.

Use	To
<b>Resolution</b> 75 dpi 150 dpi 200 dpi 300 dpi 400 dpi 600 dpi	Specify the quality of the scan in dots per inch (dpi). <b>Note:</b> 150 dpi is the factory default setting.
<b>Darkness</b> 1–9	Lighten or darken the output. <b>Note:</b> 5 is the factory default setting.
<b>Orientation</b> Portrait Landscape	Specify the orientation of the scanned image. <b>Note:</b> Portrait is the factory default setting.
<b>Original Size</b> Letter Legal Executive Folio Statement Oficio (Mexico) Universal Auto Size Sense Mixed Sizes A4 A5 A6 JIS B5 Custom Scan Size [x] Book Original Business Card 3 x 5 in. 4 x 6 in.	Specify the size of the original document. <b>Note:</b> Letter is the U.S. factory default setting. A4 is the international factory default setting.
<b>Sides (Duplex)</b> Off Long edge Short edge	Specify the orientation of the original documents loaded in the ADF for two-sided scanning. <b>Note:</b> Off is the factory default setting.
<b>JPEG Quality</b> Best for content 5–90	Set the quality of a JPEG photo image in relation to the file size and quality of the image. <b>Notes:</b> <ul style="list-style-type: none"> <li>• Best for content is the factory default setting.</li> <li>• 5 reduces the file size, but the quality of the image is lessened.</li> <li>• 90 provides the best image quality, but the file size is very large.</li> </ul>

Use	To
<b>Text Default</b> 5–90	Set the quality of the text in relation to the file size and quality of the image. <b>Note:</b> 75 is the factory default setting.
<b>Text/Photo Default</b> 5–90	Set the quality of a text/photo image in relation to the file size and quality of the image. <b>Note:</b> 75 is the factory default setting.
<b>Photo Default</b> 5–90	Set the quality of a photo image in relation to the file size and quality of the image. <b>Note:</b> 50 is the factory default setting.
<b>Use Multi-Page TIFF</b> On Off	Provide a choice between single-page TIFF files and multiple-page TIFF files. For a multiple-page scan-to-FTP job, either one TIFF file is created containing all the pages, or multiple TIFF files are created with one file for each page of the job. <b>Note:</b> On is the factory default setting.
<b>TIFF Compression</b> LZW JPEG	Specify the format used in compressing TIFF files. <b>Note:</b> LZW is the factory default setting.
<b>Transmission Log</b> Print log Do not print log Print only for error	Specify whether to print the transmission log. <b>Note:</b> Print log is the factory default setting.
<b>Log Paper Source</b> Tray [x] Multipurpose Feeder	Specify a paper source when printing FTP logs. <b>Note:</b> Tray 1 is the factory default setting.
<b>FTP bit Depth</b> 1 bit 8 bit	Enable the Text/Photo mode to have smaller file sizes by using 1-bit images. <b>Note:</b> 8 bit is the factory default setting.
<b>File Name</b>	Type a base file name.
<b>Custom Job Scanning</b> On Off	Copy a document that contains mixed paper sizes into a single scan job. <b>Note:</b> Off is the factory default setting.
<b>Scan Preview</b> On Off	Specify whether a preview appears on the display for scan jobs. <b>Notes:</b> <ul style="list-style-type: none"> <li>• Off is the factory default setting.</li> <li>• This menu item appears only when a formatted, working printer hard disk is installed.</li> </ul>
<b>Allow Save as Shortcut</b> On Off	Enable shortcut creation for FTP addresses. <b>Note:</b> On is the factory default setting.
<b>Background Removal</b> -4 to 4	Adjust the amount of background visible on a copy. <b>Note:</b> 0 is the factory default setting.

Use	To
<b>Color Balance</b> Cyan-Red Magenta-Green Yellow-Blue	Enable an equal balance of colors in the output.
<b>Color Dropout</b> Color Dropout None Red Green Blue Default Red Threshold 0–255 Default Green Threshold 0–255 Default Blue Threshold 0–255	Specify which color to drop and to adjust the dropout setting for each color threshold. <b>Notes:</b> <ul style="list-style-type: none"> <li>• None is the factory default setting for Color Dropout.</li> <li>• 128 is the factory default setting for each color threshold.</li> </ul>
<b>Contrast</b> 0–5 Best for content	Specify the contrast of the output. <b>Note:</b> Best for content is the factory default setting.
<b>Mirror Image</b> Off On	Create a mirror image of the original document. <b>Note:</b> Off is the factory default setting.
<b>Negative Image</b> Off On	Create a negative image of the original document. <b>Note:</b> Off is the factory default setting.
<b>Shadow Detail</b> -4 to 4	Adjust the amount of shadow detail visible on a scanned image. <b>Note:</b> 0 is the factory default setting.
<b>Adjust ADF Skew</b> Auto Off On	Correct slight skew in the scanned image. <b>Notes:</b> <ul style="list-style-type: none"> <li>• Auto is the factory default setting.</li> <li>• This menu item is supported only in some printer models.</li> </ul>
<b>Scan edge to edge</b> Off On	Specify whether the original document is scanned edge-to-edge. <b>Note:</b> Off is the factory default setting.
<b>Sharpness</b> 1–5	Adjust the amount of sharpness of the scanned image. <b>Note:</b> 3 is the factory default setting.
<b>Temperature</b> -4 to 4	Enable the user to specify warm or cool outputs. Cool values generate a bluer output than the default while warm values generate a redder output than the default. <b>Note:</b> 0 is the factory default setting.

## Flash Drive menu

### Scan Settings

Use	To
<b>Format</b> PDF (.pdf) TIFF (.tif) JPEG (.jpg) XPS (.xps) RTF (.rtf) TXT (.txt)	Specify the file format. <b>Note:</b> PDF (.pdf) is the factory default setting.
<b>PDF Settings</b> PDF Version 1.2–1.7 A–1a A–1b PDF Compression Normal High Secure PDF Off On Searchable PDF Off On	Configure the PDF settings. <b>Notes:</b> <ul style="list-style-type: none"> <li>• 1.5 is the factory default setting for PDF Version.</li> <li>• Normal is the factory default setting for PDF Compression.</li> <li>• Off is the factory default setting for Secure PDF and Searchable PDF. Secure PDF requires you to enter your password twice.</li> </ul>
<b>Content Type</b> Text Graphics Text/Photo Photo	Specify the content of the original document. <b>Note:</b> Text/Photo is the factory default setting.
<b>Content Source</b> Black/White Laser Color Laser Inkjet Photo/Film Magazine Newspaper Press Other	Specify how the original document was produced. <b>Note:</b> Color Laser is the factory default setting.
<b>Color</b> On Off	Specify whether the printer captures and transmits content in color. <b>Note:</b> On is the factory default setting.



Use	To
<b>Resolution</b> 75 dpi 150 dpi 200 dpi 300 dpi 400 dpi 600 dpi	Specify the resolution of the scan in dots per inch (dpi). <b>Note:</b> 150 dpi is the factory default setting.
<b>Darkness</b> 1–9	Lighten or darken the output. <b>Note:</b> 5 is the factory default setting.
<b>Orientation</b> Portrait Landscape	Specify the orientation of the scanned image. <b>Note:</b> Portrait is the factory default setting.
<b>Original Size</b> Letter Legal Executive Folio Statement Oficio (Mexico) Universal Auto Size Sense Mixed Sizes A4 A5 A6 JIS B5 Custom Scan Size [x] Book Original Business Card 3 x 5 in. 4 x 6 in.	Specify the size of the original document. <b>Note:</b> Letter is the U.S. factory default setting. A4 is the international factory default setting.
<b>Sides (Duplex)</b> Off Long edge Short edge	Specify the orientation of the original documents loaded in the ADF for two-sided scanning. <b>Note:</b> Off is the factory default setting.
<b>JPEG Quality</b> Best for content 5–90	Set the quality of a JPEG photo image in relation to file size and quality. <b>Notes:</b> <ul style="list-style-type: none"> <li>• Best for content is the factory default setting.</li> <li>• 5 reduces the file size, but the quality of the image is lessened.</li> <li>• 90 provides the best image quality, but the file size is very large.</li> </ul>
<b>Text Default</b> 5–90	Set the quality of the text in relation to file size and the quality of the image. <b>Note:</b> 75 is the factory default setting.

Use	To
<b>Text/Photo Default</b> 5–90	Set the quality of a text/photo image in relation to file size and quality. <b>Note:</b> 75 is the factory default setting.
<b>Photo Default</b> 5–90	Set the quality of a photo image in relation to file size and quality. <b>Note:</b> 50 is the factory default setting.
<b>Use Multi-Page TIFF</b> On Off	Provide a choice between single-page TIFF files and multiple-page TIFF files. For a multiple-page scan-to-FTP job, either one TIFF file is created containing all the pages, or multiple TIFF files are created with one file for each page. <b>Note:</b> On is the factory default setting.
<b>Scan Bit Depth</b> 1 bit 8 bit	Enable the Text/Photo mode to produce smaller file sizes by using 1-bit images. <b>Note:</b> 8 bit is the factory default setting.
<b>File Name</b>	Type a base file name.
<b>Custom Job Scanning</b> On Off	Copy a document that contains mixed paper sizes. <b>Note:</b> Off is the factory default setting.
<b>Scan Preview</b> On Off	Specify whether a preview appears on the display for scan jobs. <b>Notes:</b> <ul style="list-style-type: none"> <li>Off is the factory default setting.</li> <li>This menu item appears only when a formatted, working printer hard disk is installed.</li> </ul>
<b>Background Removal</b> -4 to 4	Adjust the amount of background visible on a copy. <b>Note:</b> 0 is the factory default setting.
<b>Color Balance</b> Cyan - Red Magenta - Green Yellow - Blue	Enable an equal balance of colors in the output.
<b>Color Dropout</b> Color Dropout None Red Green Blue Default Red Threshold 0–255 Default Green Threshold 0–255 Default Blue Threshold 0–255	Specify which color to drop and to adjust the dropout setting for each color threshold. <b>Notes:</b> <ul style="list-style-type: none"> <li>None is the factory default setting for Color Dropout.</li> <li>128 is the factory default setting for each color threshold.</li> </ul>
<b>Contrast</b> 0–5 Best for content	Specify the contrast of the scanned image. <b>Note:</b> Best for content is the factory default setting.

Use	To
<b>Mirror Image</b> Off On	Create a mirror image of the original document. <b>Note:</b> Off is the factory default setting.
<b>Negative Image</b> Off On	Create a negative image of the original document. <b>Note:</b> Off is the factory default setting.
<b>Shadow Detail</b> -4 to 4	Adjust the amount of shadow detail visible on a scanned image. <b>Note:</b> 0 is the factory default setting.
<b>Adjust ADF Skew</b> Auto Off On	Correct slight skew in the scanned image. <b>Note:</b> Auto is the factory default setting.
<b>Scan edge to edge</b> Off On	Specify whether the original document is scanned edge-to-edge. <b>Note:</b> Off is the factory default setting.
<b>Sharpness</b> 1–5	Adjust the amount of sharpness on a scanned image. <b>Note:</b> 3 is the factory default setting.
<b>Temperature</b> -4 to 4	Specify warm or cool outputs. Cool values generate a bluer output than the default while warm values generate a redder output than the default. <b>Note:</b> 0 is the factory default setting.

### Print Settings

<b>Copies</b> 1–999	Specify a default number of copies for each print job. <b>Note:</b> 1 is the factory default setting.
<b>Paper Source</b> Tray [x] Multipurpose Feeder Manual Paper Manual Envelope	Set a default paper source for all print jobs. <b>Note:</b> Tray 1 is the factory default setting.
<b>Color</b> Color Black only	Specify whether to print the document in color. <b>Note:</b> Color is the factory default setting.
<b>Collate</b> (1,1,1) (2,2,2) (1,2,3) (1,2,3)	Stack the pages of a print job in sequence when printing multiple copies. <b>Note:</b> (1,2,3) (1,2,3) is the factory default setting.
<b>Sides (Duplex)</b> 1 sided 2 sided	Enable two-sided printing for incoming print jobs. <b>Note:</b> 1 sided is the factory default setting.

<b>Duplex Binding</b> Long Edge Short Edge	Define binding for two-sided pages in relation to page orientation.  <b>Notes:</b> <ul style="list-style-type: none"> <li>• Long Edge is the factory default setting. This assumes binding along the long edge of the page (left edge for portrait and top edge for landscape).</li> <li>• Short Edge assumes binding along the short edge of the page (top edge for portrait and left edge for landscape).</li> </ul>
<b>Paper Saver Orientation</b> Auto Landscape Portrait	Specify the orientation of a multiple-page document.  <b>Note:</b> Auto is the factory default setting.
<b>Paper Saver</b> Off 2-Up 3-Up 4-Up 6-Up 9-Up 12-Up 16-Up	Print multiple-page images on one side of the paper.  <b>Note:</b> Off is the factory default setting.
<b>Paper Saver Border</b> None Solid	Print a border on each page image.  <b>Note:</b> None is the factory default setting.
<b>Paper Saver Ordering</b> Horizontal Reverse Horizontal Reverse Vertical Vertical	Specify the positioning of multiple-page images.  <b>Notes:</b> <ul style="list-style-type: none"> <li>• Horizontal is the factory default setting.</li> <li>• Positioning depends on the number of page images and whether they are in portrait or in landscape orientation.</li> </ul>
<b>Separator Sheets</b> Off Between Copies Between Jobs Between Pages	Specify whether to insert blank separator sheets.  <b>Note:</b> Off is the factory default setting.
<b>Separator Sheet Source</b> Tray [x] Multipurpose Feeder	Specify the paper source for separator sheets.  <b>Note:</b> Tray 1 is the factory default setting.
<b>Blank Pages</b> Do Not Print Print	Specify whether to insert blank pages in a print job.  <b>Note:</b> Do Not Print is the factory default setting.

## OCR Settings menu

Use	To
<b>Auto Rotate</b> On Off	Automatically rotate scanned documents for proper orientation. <b>Note:</b> On is the factory default setting.
<b>Despeckle</b> Off On	Remove specks from a scanned image. <b>Note:</b> Off is the factory default setting.
<b>Inverse Detection</b> On Off	Recognize and make the white text on a black background editable. <b>Note:</b> On is the factory default setting.
<b>Auto Contrast Enhance</b> Off On	Automatically adjust the contrast to improve OCR quality. <b>Note:</b> Off is the factory default setting.
<b>Recognized Languages</b> English French German Spanish Italian Portugues Danish Dutch Norwegian Swedish Finnish Hungarian Polish	Set the language or languages that the OCR can recognize. For each language, select from the following options: Off On <b>Note:</b> The language is enabled by default. If it is set to a value that is not in the list of recognized languages, English is enabled by default.

## Print Settings

### Setup menu

Use	To
<b>Printer Language</b> PCL Emulation PS Emulation	Set the default printer language. <b>Notes:</b> <ul style="list-style-type: none"> <li>• PS Emulation is the factory default printer language.</li> <li>• Setting a printer language as the default does not prevent a software program from sending print jobs that use another printer language.</li> </ul>

Use	To
<b>Job Waiting</b> On Off	Specify that print jobs be removed from the print queue if they require unavailable printer options or custom settings. They are stored in a separate print queue, so other jobs print normally. When the missing information or options are obtained, the stored jobs print.  <b>Notes:</b> <ul style="list-style-type: none"> <li>• Off is the factory default setting.</li> <li>• This menu item appears only when a formatted, working printer hard disk is installed. This requirement ensures that stored jobs are not deleted if the printer loses power.</li> </ul>
<b>Print Area</b> Normal Fit to Page Whole Page	Set the logical and physical printable area.  <b>Notes:</b> <ul style="list-style-type: none"> <li>• Normal is the factory default setting. When attempting to print data in the non-printable area defined by the Normal setting, the printer clips the image at the boundary.</li> <li>• Whole Page allows the image to be moved into the non-printable area defined by the Normal setting. Whole Page only affects pages printed using a PCL 5e interpreter. This setting has no effect on pages printed using the PCL XL or PostScript interpreter.</li> </ul>
<b>Printer Usage</b> Max Yield Max Speed	Set the printer for a faster print speed or for a higher toner yield.  <b>Note:</b> Max Yield is the factory default setting.
<b>Black Only Mode</b> On Off	Set the printer to print text and graphics using only the black toner cartridge.  <b>Note:</b> Off is the factory default setting.
<b>Download Target</b> RAM Flash Disk	Set the storage location for downloads.  <b>Notes:</b> <ul style="list-style-type: none"> <li>• RAM is the factory default setting. Storing downloads in the RAM is temporary.</li> <li>• Storing downloads in flash memory or on a printer hard disk places them in permanent storage. Downloads remain in flash memory or on the printer hard disk even when the printer is turned off.</li> <li>• This menu item appears only when a flash drive or a formatted, working printer hard disk is installed.</li> </ul>
<b>Resource Save</b> On Off	Specify how the printer handles temporary downloads, such as fonts and macros stored in the RAM, when the printer receives a job that requires more memory than is available.  <b>Notes:</b> <ul style="list-style-type: none"> <li>• Off is the factory default setting. This sets the printer to retain the downloads only until memory is needed. Downloads are deleted in order to process print jobs.</li> <li>• On retains the downloads during language changes and printer resets. If the printer runs out of memory, then <b>Memory Full [38]</b> appears, and downloads are not deleted.</li> </ul>

Use	To
<b>Print All Order</b> Alphabetical Oldest First Newest First	Specify the order in which held and confidential jobs are printed when Print All is selected.  <b>Note:</b> Alphabetical is the factory default setting. Print jobs always appear in alphabetical order on the printer control panel.

## Finishing menu

Use	To
<b>Sides (Duplex)</b> 1 sided 2 sided	Specify whether two-sided (duplex) printing is set as the default for all print jobs.  <b>Notes:</b> <ul style="list-style-type: none"> <li>• “1 sided” is the factory default setting.</li> <li>• You can set two-sided printing from the printer software.                For Windows users:                Click <b>File &gt; Print</b>, and then click <b>Properties, Preferences, Options, or Setup</b>.                For Macintosh users:                Choose <b>File &gt; Print</b>, and then adjust the settings from the Print dialog and pop-up menus.</li> </ul>
<b>Duplex Binding</b> Long Edge Short Edge	Define binding for duplexed pages in relation to page orientation.  <b>Notes:</b> <ul style="list-style-type: none"> <li>• Long Edge is the factory default setting. This assumes binding along the long edge of the page (left edge for portrait and top edge for landscape).</li> <li>• Short Edge assumes binding along the short edge of the page (top edge for portrait and left edge for landscape).</li> </ul>
<b>Copies</b> 1–999	Specify the default number of copies for each print job.  <b>Note:</b> 1 is the factory default setting.
<b>Blank Pages</b> Do Not Print Print	Specify whether blank pages are inserted in a print job.  <b>Note:</b> Do Not Print is the factory default setting.
<b>Collate</b> (1,1,1) (2,2,2) (1,2,3) (1,2,3)	Stack the pages of a print job in sequence when printing multiple copies.  <b>Note:</b> “(1,2,3) (1,2,3)” is the factory default setting.

Use	To
<b>Separator Sheets</b> Off Between Copies Between Jobs Between Pages	Specify whether blank separator sheets are inserted. <b>Notes:</b> <ul style="list-style-type: none"> <li>Off is the factory default setting.</li> <li>Between Copies inserts a blank sheet between each copy of a print job if Collate is set to "(1,2,3) (1,2,3)." If Collate is set to "(1,1,1) (2,2,2)," then a blank page is inserted between each set of printed pages, such as after all page 1's and after all page 2's.</li> <li>Between Jobs inserts a blank sheet between print jobs.</li> <li>Between Pages inserts a blank sheet between each page of a print job. This setting is useful when printing transparencies or when inserting blank pages in a document.</li> </ul>
<b>Separator Source</b> Tray [x] Multipurpose Feeder	Specify the paper source for the separator sheet. <b>Note:</b> Tray 1 (standard tray) is the factory default setting.
<b>Paper Saver</b> Off 2-Up 3-Up 4-Up 6-Up 9-Up 12-Up 16-Up	Print multiple pages on a single sheet of paper. <b>Notes:</b> <ul style="list-style-type: none"> <li>Off is the factory default setting.</li> <li>When the number of pages per sheet is selected, each page is scaled so that the number of pages you want can be displayed on the sheet.</li> </ul>
<b>Paper Saver Ordering</b> Horizontal Reverse Horizontal Reverse Vertical Vertical	Specify the order in which pages are printed on a single sheet when using Paper Saver. <b>Notes:</b> <ul style="list-style-type: none"> <li>Horizontal is the factory default setting.</li> <li>Positioning depends on the number of page images and whether they are in portrait or in landscape orientation.</li> </ul>
<b>Paper Saver Orientation</b> Auto Landscape Portrait	Specify the orientation in which pages are printed on a single sheet. <b>Note:</b> Auto is the factory default setting. The printer chooses between portrait and landscape.
<b>Paper Saver Border</b> None Solid	Print a border when using Paper Saver. <b>Note:</b> None is the factory default setting.

## Quality menu

Use	To
<b>Print Mode</b> Color Black Only	Specify whether to print images in color. <b>Note:</b> Color is the factory default setting.



Use	To
<b>Color Correction</b> Auto Off Manual	Adjust the color output on the printed page. <b>Note:</b> Auto is the factory default setting.
<b>Print Resolution</b> 1200 dpi 4800 CQ	Specify the output resolution in dots per inch (dpi) or in color quality (CQ). <b>Note:</b> 4800 CQ is the factory default setting.
<b>Toner Darkness</b> 1–5	Lighten or darken the output. <b>Note:</b> 4 is the factory default setting.
<b>Enhance Fine Lines</b> On Off	Enable a print mode preferable for files such as architectural drawings, maps, electrical circuit diagrams, and flow charts. <b>Note:</b> Off is the factory default setting.
<b>Color Saver</b> On Off	Reduce the amount of toner used for graphics and images. <b>Notes:</b> <ul style="list-style-type: none"> <li>• Off is the factory default setting.</li> <li>• On overrides the Toner Darkness setting.</li> </ul>
<b>RGB Brightness</b> -6 to 6	Adjust the brightness of the output. <b>Note:</b> 0 is the factory default setting.
<b>RGB Contrast</b> 0–5	Adjust the contrast of the output. <b>Note:</b> 0 is the factory default setting.
<b>RGB Saturation</b> 0–5	Adjust saturation in color outputs. <b>Note:</b> 0 is the factory default setting.
<b>Color Balance</b> Cyan -5 to 5 Magenta -5 to 5 Yellow -5 to 5 Black -5 to 5 Reset Defaults	Enable an equal balance of colors in the output. <b>Note:</b> 0 is the factory default setting.

Use	To
<p><b>Color Samples</b></p> <ul style="list-style-type: none"> <li>sRGB Display</li> <li>sRGB Vivid</li> <li>Display—True Black</li> <li>Vivid</li> <li>Off—RGB</li> <li>US CMYK</li> <li>Euro CMYK</li> <li>Vivid CMYK</li> <li>Off—CMYK</li> </ul>	<p>Print sample pages for each of the RGB and CMYK color conversion tables used in the printer.</p>
<p><b>Manual Color</b></p> <ul style="list-style-type: none"> <li>RGB Image</li> <li>RGB Text</li> <li>RGB Graphics</li> </ul>	<p>Customize the RGB color conversions.</p> <p>Select from the following options:</p> <ul style="list-style-type: none"> <li>Vivid</li> <li>sRGB Display</li> <li>Display—True Black</li> <li>sRGB Vivid</li> <li>Off</li> </ul> <p><b>Notes:</b></p> <ul style="list-style-type: none"> <li>• sRGB Display is the factory default setting for RGB Image.</li> <li>• sRGB Vivid is the factory default setting for RGB Text and RGB Graphics.</li> </ul>
<p><b>Manual Color (continued)</b></p> <ul style="list-style-type: none"> <li>CMYK Image</li> <li>CMYK Text</li> <li>CMYK Graphics</li> </ul>	<p>Customize the CMYK color conversions.</p> <p>Select from the following options:</p> <ul style="list-style-type: none"> <li>US CMYK</li> <li>Euro CMYK</li> <li>Vivid CMYK</li> <li>Off</li> </ul> <p><b>Note:</b> US CMYK is the U.S. factory default setting. Euro CMYK is the international factory default setting.</p>
<p><b>Color Adjust</b></p>	<p>Initiate a recalibration of color conversion tables and allow the printer to make adjustments for color variations in output.</p>
<p><b>Spot Color Replacement</b></p>	<p>Assign specific CMYK values to named spot colors.</p> <p><b>Note:</b> This menu is available only on the Embedded Web Server.</p>
<p><b>RGB Replacement</b></p>	<p>Match the colors of the output with that of the original document.</p> <p><b>Note:</b> This menu is available only on the Embedded Web Server.</p>

**Job Accounting menu**

**Note:** This menu item appears only when a formatted, working printer hard disk is installed.

Use	To
<p><b>Job Accounting Log</b></p> <ul style="list-style-type: none"> <li>Off</li> <li>On</li> </ul>	<p>Determine and set if the printer creates a log of the print jobs it receives.</p> <p><b>Note:</b> Off is the factory default setting.</p>

Use	To
<b>Job Accounting Utilities</b>	Print and delete log files or export them to a flash drive.
<b>Accounting Log Frequency</b> Daily Weekly Monthly	Determine and set how often a log file is created. <b>Note:</b> Monthly is the factory default setting.
<b>Log Action at End of Frequency</b> None E-mail Current Log E-mail & Delete Current Log Post Current Log Post & Delete Current Log	Determine and set how the printer responds when the frequency threshold expires. <b>Note:</b> None is the factory default setting.
<b>Log Near Full Level</b> Off 1–99	Specify the maximum size of the log file before the printer executes the Log Action at Near Full. <b>Note:</b> 5 is the factory default setting.
<b>Log Action at Near Full</b> None E-mail Current Log E-mail & Delete Current Log E-mail & Delete Oldest Log Post Current Log Post & Delete Current Log Post & Delete Oldest Log Delete Current Log Delete Oldest Log Delete All Logs Delete All But Current	Determine and set how the printer responds when the hard disk is nearly full. <b>Notes:</b> <ul style="list-style-type: none"> <li>• None is the factory default setting.</li> <li>• The value defined in Log Near Full Level determines when this action is triggered.</li> </ul>
<b>Log Action at Full</b> None E-mail & Delete Current Log E-mail & Delete Oldest Log Post & Delete Current Log Post & Delete Oldest Log Delete Current Log Delete Oldest Log Delete All Logs Delete All But Current	Determine and set how the printer responds when disk usage reaches the maximum limit (100MB). <b>Note:</b> None is the factory default setting.
<b>URL to Post Logs</b>	Determine and set where the printer posts job accounting logs.
<b>E-mail Address to Send Logs</b>	Specify the e-mail address to which the printer sends job accounting logs.
<b>Log File Prefix</b>	Specify the prefix you want for the log file name. <b>Note:</b> The current host name defined in the TCP/IP menu is used as the default log file prefix.

## Utilities menu

Use	To
<b>Remove Held Jobs</b> Confidential Held Not Restored All	Delete confidential and held jobs from the printer hard disk.  <b>Notes:</b> <ul style="list-style-type: none"> <li>• Selecting a setting affects only print jobs that are resident in the printer. Bookmarks, print jobs on flash drives, and other types of held jobs are not affected.</li> <li>• Not Restored removes all Print and Hold jobs that are <i>not</i> restored from the printer hard disk or memory.</li> </ul>
<b>Format Flash</b> Yes No	Format the flash memory.  <b>Warning—Potential Damage:</b> Do not turn off the printer while the flash memory is being formatted.  <b>Notes:</b> <ul style="list-style-type: none"> <li>• Yes deletes all data stored in flash memory.</li> <li>• No cancels the format request.</li> <li>• Flash memory refers to the memory added by installing a flash memory card in the printer.</li> <li>• The flash memory option card must not be read/write- or write-protected.</li> <li>• This menu item appears only when a non-defective flash memory card is installed.</li> </ul>
<b>Delete Downloads on Disk</b> Delete Now Do Not Delete	Delete downloads from the printer hard disk, including all held jobs, buffered jobs, and parked jobs.  <b>Notes:</b> <ul style="list-style-type: none"> <li>• Delete Now sets the printer to delete the downloads and allows the display to return to the originating screen after the deletion.</li> <li>• Do Not Delete sets the printer display to return to the main Utilities menu for touch-screen printer models. When selected in non-touch-screen printer models, Do Not Delete sets the printer to return to the originating screen after the deletion.</li> </ul>
<b>Activate Hex Trace</b>	Assist in isolating the source of a print job problem.  <b>Notes:</b> <ul style="list-style-type: none"> <li>• When activated, all data sent to the printer is printed in hexadecimal and character representation, and control codes are not executed.</li> <li>• To exit or deactivate Hex Trace, turn off or reset the printer.</li> </ul>
<b>Coverage Estimator</b> Off On	Provide an estimate of the percentage coverage of toner on a page. The estimate is printed on a separate page at the end of each print job.  <b>Note:</b> Off is the factory default setting.

**XPS menu**

Use	To
<b>Print Error Pages</b> Off On	Print a page containing information on errors, including XML markup errors. <b>Note:</b> Off is the factory default setting.

**PDF menu**

Use	To
<b>Scale to Fit</b> Yes No	Scale page content to fit the selected paper size. <b>Note:</b> No is the factory default setting.
<b>Annotations</b> Do Not Print Print	Print annotations in a PDF. <b>Note:</b> Do Not Print is the factory default setting.

**PostScript menu**

Use	To
<b>Print PS Error</b> On Off	Print a page containing the PostScript error. <b>Note:</b> Off is the factory default setting.
<b>Lock PS Startup Mode</b> On Off	Enable users to disable the SysStart file. <b>Note:</b> Off is the factory default setting.
<b>Font Priority</b> Resident Flash/Disk	Establish the font search order. <b>Notes:</b> <ul style="list-style-type: none"> <li>Resident is the factory default setting.</li> <li>This menu item appears only when a formatted, non-defective flash memory option card or printer hard disk is installed.</li> <li>Make sure the flash memory option or printer hard disk is not read/write-, write-, or password-protected.</li> <li>Job Buffer Size must not be set to 100%.</li> </ul>
<b>Image Smoothing</b> On Off	Enhance the contrast and sharpness of low-resolution images and smoothen their color transitions. <b>Notes:</b> <ul style="list-style-type: none"> <li>Off is the factory default setting.</li> <li>Image Smoothing has no effect on images that are 300 dpi or higher in resolution.</li> </ul>

## PCL Emul menu

Use	To
<b>Font Source</b> Resident Disk Download Flash All	Specify the set of fonts used by the Font Name menu.  <b>Notes:</b> <ul style="list-style-type: none"> <li>• “Resident” is the factory default setting. Resident shows the factory default set of fonts downloaded in the RAM.</li> <li>• “Flash” and “Disk” settings show all fonts resident in that option.</li> <li>• The flash option must be properly formatted and cannot be read/write-, write-, or password-protected.</li> <li>• “Download” shows all the fonts downloaded in the RAM.</li> <li>• “All” shows all fonts available to any option.</li> </ul>
<b>Font Name</b> Courier 10	Identify a specific font and the option where it is stored.  <b>Note:</b> Courier 10 is the factory default setting. Courier 10 shows the font name, font ID, and the storage location in the printer. The font source abbreviation is R for Resident, F for Flash, K for Disk, and D for Download.
<b>Symbol Set</b> 10U PC-8 12U PC-850	Specify the symbol set for each font name.  <b>Notes:</b> <ul style="list-style-type: none"> <li>• 10U PC-8 is the US factory default setting. 12U PC-850 is the international factory default setting.</li> <li>• A symbol set is a set of alphabetic and numeric characters, punctuation, and special symbols. Symbol sets support the different languages or specific programs such as math symbols for scientific text. Only the supported symbol sets are shown.</li> </ul>
<b>PCL Emulation Settings</b> Point Size 1.00–1008.00	Change the point size for scalable typographic fonts.  <b>Notes:</b> <ul style="list-style-type: none"> <li>• 12 is the factory default setting.</li> <li>• Point size refers to the height of the characters in the font. One point equals approximately 0.014 inch.</li> <li>• Point sizes can be increased or decreased in 0.25-point increments.</li> </ul>
<b>PCL Emulation Settings</b> Pitch 0.08–100	Specify the font pitch for scalable monospaced fonts.  <b>Notes:</b> <ul style="list-style-type: none"> <li>• 10 is the factory default setting.</li> <li>• Pitch refers to the number of fixed-space characters per inch (cpi).</li> <li>• Pitch can be increased or decreased in 0.01-cpi increments.</li> <li>• For nonscalable monospaced fonts, the pitch appears on the display but it cannot be changed.</li> </ul>
<b>PCL Emulation Settings</b> Orientation Portrait Landscape	Specify the orientation of text and graphics on the page.  <b>Notes:</b> <ul style="list-style-type: none"> <li>• Portrait is the factory default setting. Portrait prints text and graphics parallel to the short edge of the page.</li> <li>• Landscape prints text and graphics parallel to the long edge of the page.</li> </ul>

Use	To
<b>PCL Emulation Settings</b> Lines per Page 1–255	Specify the number of lines that print on each page. <b>Notes:</b> <ul style="list-style-type: none"> <li>• 60 is the US factory default setting. 64 is the international default setting.</li> <li>• The printer sets the amount of space between each line based on the Lines per Page, Paper Size, and Orientation settings. Select the Paper Size and Orientation you want before setting Lines per Page.</li> </ul>
<b>PCL Emulation Settings</b> A4 Width 198 mm 203 mm	Set the printer to print on A4-size paper. <b>Notes:</b> <ul style="list-style-type: none"> <li>• “198 mm” is the factory default setting.</li> <li>• The 203-mm setting sets the width of the page to allow printing of eighty 10-pitch characters.</li> </ul>
<b>PCL Emulation Settings</b> Auto CR after LF On Off	Specify whether the printer automatically performs a carriage return (CR) after a line feed (LF) control command. <b>Note:</b> Off is the factory default setting.
<b>PCL Emulation Settings</b> Auto LF after CR On Off	Specify whether the printer automatically performs a line feed (LF) after a carriage return (CR) control command. <b>Note:</b> Off is the factory default setting.
<b>Tray Renumber</b> Assign MP Feeder Off None 0–199 Assign Tray [x] Off None 0–199 Assign Manual Paper Off None 0–199 Assign Manual Env Off None 0–199	Configure the printer to work with printer software or programs that use different source assignments for trays and feeders. <b>Notes:</b> <ul style="list-style-type: none"> <li>• “Off” is the factory default setting.</li> <li>• “None” ignores the Select Paper Feed command. This option appears only when it is selected by the PCL 5 interpreter.</li> <li>• “0–199” allows a custom setting to be assigned.</li> </ul>

Use	To
<p><b>Tray Renumber</b></p> <ul style="list-style-type: none"> <li>View Factory Defaults</li> <li>MPF Default = 8</li> <li>T1 Default = 1</li> <li>T1 Default = 4</li> <li>T1 Default = 5</li> <li>T1 Default = 20</li> <li>T1 Default = 21</li> <li>Env Default = 6</li> <li>MPaper Default = 2</li> <li>MEnv Default = 3</li> </ul>	<p>Display the factory default setting assigned to each tray or feeder.</p>
<p><b>Tray Renumber</b></p> <ul style="list-style-type: none"> <li>Restore Defaults</li> <li>Yes</li> <li>No</li> </ul>	<p>Restore all tray and feeder assignments to the factory default settings.</p>

**HTML menu**

Use		To
<p><b>Font Name</b></p> <ul style="list-style-type: none"> <li>Albertus MT</li> <li>Antique Olive</li> <li>Apple Chancery</li> <li>Arial MT</li> <li>Avant Garde</li> <li>Bodoni</li> <li>Bookman</li> <li>Chicago</li> <li>Clarendon</li> <li>Cooper Black</li> <li>Copperplate</li> <li>Coronet</li> <li>Courier</li> <li>Eurostile</li> <li>Garamond</li> <li>Geneva</li> <li>Gill Sans</li> <li>Goudy</li> <li>Helvetica</li> <li>Hoefler Text</li> <li>Intl CG Times</li> <li>Intl Courier</li> <li>Intl Univers</li> </ul>	<ul style="list-style-type: none"> <li>Joanna MT</li> <li>Letter Gothic</li> <li>Lubalin Graph</li> <li>Marigold</li> <li>MonaLisa Recut</li> <li>Monaco</li> <li>New CenturySbk</li> <li>New York</li> <li>Optima</li> <li>Oxford</li> <li>Palatino</li> <li>StempelGaramond</li> <li>Taffy</li> <li>Times</li> <li>TimesNewRoman</li> <li>Univers</li> <li>Zapf Chancery</li> <li>NewSansMTCS</li> <li>NewSansMTCT</li> <li>New SansMTJA</li> <li>NewSansMTKO</li> </ul>	<p>Set the default font for HTML documents.</p> <p><b>Note:</b> The Times font is used in HTML documents that do not specify a font.</p>



Use	To
<b>Font Size</b> 1–255 pt	Set the default font size for HTML documents.  <b>Notes:</b> <ul style="list-style-type: none"> <li>• 12 pt is the factory default setting.</li> <li>• Font size can be increased in 1-point increments.</li> </ul>
<b>Scale</b> 1–400%	Scale the default font for HTML documents.  <b>Notes:</b> <ul style="list-style-type: none"> <li>• 100% is the factory default setting.</li> <li>• Scaling can be increased in 1% increments.</li> </ul>
<b>Orientation</b> Portrait Landscape	Set the page orientation for HTML documents.  <b>Note:</b> Portrait is the factory default setting.
<b>Margin Size</b> 8–255 mm	Set the page margin for HTML documents.  <b>Notes:</b> <ul style="list-style-type: none"> <li>• 19 mm is the factory default setting.</li> <li>• Margin size can be increased in 1-mm increments.</li> </ul>
<b>Backgrounds</b> Do Not Print Print	Specify whether to print backgrounds on HTML documents.  <b>Note:</b> Print is the factory default setting.

## Image menu

Use	To
<b>Auto Fit</b> On Off	Select the optimal paper size, scaling, and orientation.  <b>Note:</b> On is the factory default setting. It overrides scaling and orientation settings for some images.
<b>Invert</b> On Off	Invert bitonal monochrome images.  <b>Notes:</b> <ul style="list-style-type: none"> <li>• Off is the factory default setting.</li> <li>• This setting does not apply to GIF or JPEG images.</li> </ul>
<b>Scaling</b> Anchor Top Left Best Fit Anchor Center Fit Height/Width Fit Height Fit Width	Scale the image to fit the selected paper size.  <b>Notes:</b> <ul style="list-style-type: none"> <li>• Best Fit is the factory default setting.</li> <li>• When Auto Fit is set to On, Scaling is automatically set to Best Fit.</li> </ul>

Use	To
<b>Orientation</b> Portrait Landscape Reverse Portrait Reverse Landscape	Set the image orientation. <b>Note:</b> Portrait is the factory default setting.

## Help menu

Menu item	Description
Print All Guides	Prints all the guides
Copy Guide	Provides information about making copies and configuring the settings
E-mail Guide	Provides information about sending e-mails and configuring the settings
Fax Guide	Provides information about sending faxes and configuring the settings
FTP Guide	Provides information about scanning documents and configuring the settings
Color Quality	Provides information about solving color quality issues
Print Defects Guide	Provides help in resolving repeating defects in copies or prints
Information Guide	Provides help in locating additional information
Supplies Guide	Provides information about ordering supplies

## Saving money and the environment

Lexmark is committed to environmental sustainability and is continually improving its printers to reduce their impact on the environment. We design with the environment in mind, engineer our packaging to reduce materials, and provide collection and recycling programs. For more information, see:

- The Notices chapter
- The Environmental Sustainability section of the Lexmark Web site at [www.lexmark.com/environment](http://www.lexmark.com/environment)
- The Lexmark recycling program at [www.lexmark.com/recycle](http://www.lexmark.com/recycle)

By selecting certain printer settings or tasks, you may be able to reduce your printer's impact even further. This chapter outlines the settings and tasks that may yield a greater environmental benefit.

### Saving paper and toner

Studies show that as much as 80% of the carbon footprint of a printer is related to paper usage. You can significantly reduce your carbon footprint by using recycled paper and the following printing suggestions, such as printing on both sides of the paper and printing multiple pages on one side of a single sheet of paper.

For more information on how you can quickly save paper and energy using one printer setting, see [“Using Eco-Mode” on page 196](#).

#### Using recycled paper

As an environmentally conscious company, Lexmark supports the use of recycled office paper produced specifically for use in laser printers. For more information on recycled papers that work well with your printer, see [“Using recycled paper and other office papers” on page 57](#).

#### Conserving supplies

##### Use both sides of the paper

If your printer model supports two-sided printing, then you can control whether print appears on one or two sides of the paper.

##### Notes:

- Two-sided printing is the default setting in the print driver.
- For a complete list of supported products and countries, go to <http://support.lexmark.com>.

##### Place multiple pages on one sheet of paper

You can print up to 16 consecutive pages of a multiple-page document onto one side of a single sheet of paper by setting multiple page printing (N-Up) for the print job.

## Check your first draft for accuracy

Before printing or making multiple copies of a document:

- Use the preview feature to see how the document looks like before you print it.
- Print one copy of the document to check its content and format for accuracy.

## Avoid paper jams

Correctly set the paper type and size to avoid paper jams. For more information, see [“Avoiding jams” on page 235](#).

# Saving energy

## Using Eco-Mode

- 1 Open a Web browser, and then type the printer IP address in the address field.

### Notes:

- View the printer IP address on the printer home screen. The IP address appears as four sets of numbers separated by periods, such as 123.123.123.123.
- If you are using a proxy server, then temporarily disable it to load the Web page correctly.

- 2 Click **Settings > General Settings > Eco-Mode >** select a setting

Use	To
Off	Use the factory default settings for all settings associated with Eco-Mode. Off supports the performance specifications of the printer.
Energy	Reduce energy use, especially when the printer is idle. <ul style="list-style-type: none"> <li>• Printer engine motors do not start until it is ready to print. You may notice a short delay before the first page is printed.</li> <li>• The printer enters Sleep mode after one minute of inactivity.</li> </ul>
Energy/Paper	Use all the settings associated with Energy and Paper modes.
Plain Paper	<ul style="list-style-type: none"> <li>• Enable the automatic two-sided (duplex) feature.</li> <li>• Turn off print log features.</li> </ul>

- 3 Click **Submit**.

## Reducing printer noise

Enable Quiet Mode to reduce printer noise.

- 1 Open a Web browser, and then type the printer IP address in the address field.

### Notes:

- View the printer IP address on the printer home screen. The IP address appears as four sets of numbers separated by periods, such as 123.123.123.123.
- If you are using a proxy server, then temporarily disable it to load the Web page correctly.

- 2 Click **Settings > General Settings > Quiet Mode >** select a setting

Use	To
On	Reduce printer noise. <b>Notes:</b> <ul style="list-style-type: none"> <li>• Print jobs are processed at a reduced speed.</li> <li>• Printer engine motors do not start until a document is ready to print. There will be a short delay before the first page is printed.</li> </ul>
Off	Use factory default settings. <b>Note:</b> This setting supports the performance specifications of the printer.

3 Click **Submit**.

## Adjusting Sleep mode

1 From the home screen, navigate to:

 > **Settings** > **General Settings** > **Timeouts** > **Sleep Mode**

2 In the Sleep Mode field, select the number of minutes the printer is idle before it enters Sleep mode.

3 Apply the changes.

## Using Hibernate mode

Hibernate is an ultra-low-power operating mode.

### Notes:

- Three days is the default amount of time before the printer enters Hibernate mode.
- Make sure to wake the printer from Hibernate mode before sending a print job. A hard reset or a long press of the Sleep button wakes the printer from Hibernate mode.
- If the printer is in Hibernate mode, then the Embedded Web Server is disabled.

1 From the home screen, navigate to:

 > **Settings** > **General Settings**

2 From the “Press Sleep Button” or “Press and Hold Sleep Button” menu, select **Hibernate**, and then touch **Submit**.

## Setting Hibernate Timeout

Hibernate Timeout lets you set the amount of time the printer waits after a print job is processed before it goes into a reduced power state.

### Using the Embedded Web Server

1 Open a Web browser, and then type the printer IP address in the address field.

**Notes:**

- View the printer IP address on the printer home screen. The IP address appears as four sets of numbers separated by periods, such as 123.123.123.123.
- If you are using a proxy server, then temporarily disable it to load the Web page correctly.

**2** Click **Settings > General Settings > Timeouts**.

**3** From the Hibernate Timeout menu, select the number of hours, days, weeks, or months you want for the printer to wait before it goes into a reduced power state.

**4** Click **Submit**.

**Using the printer control panel**

**1** From the printer control panel, navigate to:



**> Settings > General Settings > Timeouts > Hibernate Timeout**

**2** Select the amount of time the printer waits after a print job is processed before it enters Hibernate mode.

**3** Touch **Submit**.

**Using Schedule Power Modes**

Schedule Power Modes lets you schedule when the printer goes into a reduced power state or into Ready state.

**Note:** This feature is available only in network printers or printers connected to print servers.

**Using the Embedded Web Server**

**1** Open a Web browser, and then type the printer IP address in the address field.

**Notes:**

- View the printer IP address on the printer home screen. The IP address appears as four sets of numbers separated by periods, such as 123.123.123.123.
- If you are using a proxy server, then temporarily disable it to load the Web page correctly.

**2** Click **Settings > General Settings > Schedule Power Modes**.

**3** From the Action menu, select the power mode.

**4** From the Time menu, select the time.

**5** From the Day(s) menu, select the day or days.

**6** Click **Add**.

**Adjusting the brightness of the printer display**

To save energy, or if you have trouble reading the display, adjust its brightness settings.

**Using the Embedded Web Server**

**1** Open a Web browser, and then type the printer IP address in the address field.

**Notes:**

- View the printer IP address in the TCP/IP section in the Network/Ports menu. The IP address appears as four sets of numbers separated by periods, such as 123.123.123.123.
- If you are using a proxy server, then temporarily disable it to load the Web page correctly.

**2** Click **Settings > General Settings**.

**3** In the Screen Brightness field, enter the brightness percentage you want for the display.

**4** Click **Submit**.

## Recycling

Lexmark provides collection programs and environmentally progressive approaches to recycling. For more information, see:

- The Notices chapter
- The Environmental Sustainability section of the Lexmark Web site at [www.lexmark.com/environment](http://www.lexmark.com/environment)
- The Lexmark recycling program at [www.lexmark.com/recycle](http://www.lexmark.com/recycle)

### Recycling Lexmark products

To return Lexmark products for recycling:

- 1** Go to [www.lexmark.com/recycle](http://www.lexmark.com/recycle).
- 2** Find the product type you want to recycle, and then select your country or region from the list.
- 3** Follow the instructions on the computer screen.

**Note:** Printer supplies and hardware not listed in the Lexmark collection program may be recycled through your local recycling center. Contact your local recycling center to determine the items they accept.

### Recycling Lexmark packaging

Lexmark continually strives to minimize packaging. Less packaging helps to ensure that Lexmark printers are transported in the most efficient and environmentally sensitive manner and that there is less packaging to dispose of. These efficiencies result in fewer greenhouse emissions, energy savings, and natural resource savings.

Lexmark cartons are 100% recyclable where corrugated recycling facilities exist. Facilities may not exist in your area.

The foam used in Lexmark packaging is recyclable where foam recycling facilities exist. Facilities may not exist in your area.

When you return a cartridge to Lexmark, you can reuse the box that the cartridge came in. Lexmark will recycle the box.

### Returning Lexmark cartridges for reuse or recycling

Lexmark Cartridge Collection Program diverts millions of Lexmark cartridges from landfills annually by making it both easy and free for Lexmark customers to return used cartridges to Lexmark for reuse or recycling. One hundred percent of the empty cartridges returned to Lexmark are either reused or demanufactured for recycling. Boxes used to return the cartridges are also recycled.

To return Lexmark cartridges for reuse or recycling, follow the instructions that came with your printer or cartridge and use the prepaid shipping label. You can also do the following:

- 1** Go to [www.lexmark.com/recycle](http://www.lexmark.com/recycle).
- 2** From the Toner Cartridges section, select your country or region.
- 3** Follow the instructions on the computer screen.



## Securing the printer

### Using the security lock feature

The printer is equipped with a security lock feature. Attach a security lock compatible with most laptop computers in the location shown to secure the printer in place.



### Statement of Volatility

Your printer contains various types of memory that can store device and network settings, and user data.

Type of memory	Description
Volatile memory	Your printer uses standard <i>random access memory</i> (RAM) to temporarily buffer user data during simple print jobs.
Non-volatile memory	Your printer may use two forms of non-volatile memory: EEPROM and NAND (flash memory). Both types are used to store the operating system, device settings, network information and bookmark settings, and embedded solutions.
Hard disk memory	Some printers have a hard disk drive installed. The printer hard disk is designed for printer-specific functionality. This lets the printer retain buffered user data from complex print jobs, as well as form data, and font data.

Erase the content of any installed printer memory in the following circumstances:

- The printer is being decommissioned.
- The printer hard disk is being replaced.

- The printer is being moved to a different department or location.
- The printer is being serviced by someone from outside your organization.
- The printer is being removed from your premises for service.
- The printer is being sold to another organization.

## Disposing of a printer hard disk

**Note:** Some printer models may not have a printer hard disk installed.

In high-security environments, it may be necessary to take additional steps to make sure that confidential data stored in the printer hard disk cannot be accessed when the printer—or its hard disk—is removed from your premises.

- **Degaussing**—Flushes the hard disk with a magnetic field that erases stored data
- **Crushing**—Physically compresses the hard disk to break component parts and render them unreadable
- **Milling**—Physically shreds the hard disk into small metal bits

**Note:** Most data can be erased electronically, but the only way to guarantee that all data are completely erased is to physically destroy each hard disk where data is stored.

## Erasing volatile memory

The volatile memory (RAM) installed in your printer requires a power source to retain information. To erase the buffered data, simply turn off the printer.

## Erasing non-volatile memory

Erase individual settings, device and network settings, security settings, and embedded solutions by following these steps:

- 1 Turn off the printer.
- 2 Hold down **2** and **6** while turning the printer on. Release the buttons only when the screen with the progress bar appears.

The printer performs a power-on sequence, and then the Configuration menu appears. When the printer is fully turned on, a list of functions appears on the printer display, instead of the standard home screen icons.

- 3 Touch **Wipe All Settings**.

The printer restarts several times during this process.

**Note:** Wipe All Settings securely removes device settings, solutions, jobs, and passwords from the printer memory.

- 4 Touch **Back > Exit Config Menu**.

The printer will perform a power-on reset, and then return to normal operating mode.

## Erasing printer hard disk memory

### Notes:

- Some printer models may not have a printer hard disk installed.
- Configuring Erase Temporary Data Files in the printer menus lets you remove residual confidential material left by print jobs by securely overwriting files that have been marked for deletion.

### Using the printer control panel

- 1 Turn off the printer.
- 2 Hold down **2** and **6** while turning the printer on. Release the buttons only when the screen with the progress bar appears.

The printer performs a power-on sequence, and then the Configuration menu appears. When the printer is fully turned on, the touch screen displays a list of functions.

- 3 Touch **Wipe Disk**, and then touch one of the following:
  - **Wipe disk (fast)**—This lets you overwrite the disk with all zeroes in a single pass.
  - **Wipe disk (secure)**—This lets you overwrite the disk with random bit patterns several times, followed by a verification pass. A secure overwrite is compliant with the DoD 5220.22-M standard for securely erasing data from a hard disk. Highly confidential information should be wiped using this method.
- 4 Touch **Yes** to proceed with disk wiping.

### Notes:

- A status bar will indicate the progress of the disk wiping task.
- Disk wiping can take from several minutes to more than an hour, during which the printer will be unavailable for other user tasks.

- 5 Touch **Back > Exit Config Menu**.

The printer will perform a power-on reset, and then return to normal operating mode.

## Configuring printer hard disk encryption

Enable hard disk encryption to prevent loss of sensitive data in the event the printer or its hard disk is stolen.

**Note:** Some printer models may not have a printer hard disk installed.

### Using the Embedded Web Server

- 1 Open a Web browser, and then type the printer IP address in the address field.

### Notes:

- View the printer IP address on the printer home screen. The IP address appears as four sets of numbers separated by periods, such as 123.123.123.123.
- If you are using a proxy server, then temporarily disable it to load the Web page correctly.

- 2 Click **Settings > Security > Disk Encryption**.

**Note:** Disk Encryption appears in the Security Menu only when a formatted, non-defective printer hard disk is installed.

**3** From the Disk encryption menu, select **Enable**.

**Notes:**

- Enabling disk encryption will erase the contents of the printer hard disk.
- Disk encryption can take from several minutes to more than an hour, during which the printer will be unavailable for other user tasks.

**4** Click **Submit**.

## Using the printer control panel

**1** Turn off the printer.

**2** Hold down **2** and **6** while turning the printer on. Release the buttons only when the screen with the progress bar appears.

The printer performs a power-on sequence, and then the Configuration menu appears. When the printer is fully turned on, a list of functions appears on the printer display.

**3** Touch **Disk Encryption > Enable**.

**Note:** Enabling disk encryption will erase the contents of the printer hard disk.

**4** Touch **Yes** to proceed with disk wiping.

**Notes:**

- Do not turn off the printer during the encryption process. Doing so may result in loss of data.
- Disk encryption can take from several minutes to more than an hour, during which the printer will be unavailable for other user tasks.
- A status bar will indicate the progress of the disk wiping task. After the disk has been encrypted, the printer will return to the Enable/Disable screen.

**5** Touch **Back > Exit Config Menu**.

The printer will perform a power-on reset, and then return to normal operating mode.

## Finding printer security information

In high-security environments, it may be necessary to take additional steps to make sure that confidential data stored in the printer cannot be accessed by unauthorized persons. For more information, go to the [Lexmark security Web page](#) or see the *Embedded Web Server—Security: Administrator's Guide* at <http://support.lexmark.com>.

# Maintaining the printer

**Warning—Potential Damage:** Failure to maintain optimum printer performance, or to replace parts and supplies, may cause damage to your printer.

## Cleaning printer parts

### Cleaning the printer

**Note:** You may need to perform this task after every few months.

**Warning—Potential Damage:** Damage to the printer caused by improper handling is not covered by the printer warranty.

- 1 Make sure that the printer is turned off and unplugged from the electrical outlet.



**CAUTION—SHOCK HAZARD:** To avoid the risk of electrical shock when cleaning the exterior of the printer, unplug the power cord from the electrical outlet and disconnect all cables from the printer before proceeding.

- 2 Remove paper from the standard bin, multipurpose feeder, and manual feeder.
- 3 Remove any dust, lint, and pieces of paper around the printer using a soft brush or vacuum.
- 4 Dampen a clean, lint-free cloth with water, and use it to wipe the outside of the printer.

**Warning—Potential Damage:** Do not use household cleaners or detergents, as they may damage the finish of the printer.

- 5 Make sure all areas of the printer are dry before sending a new print job.

## Cleaning the scanner glass

Clean the scanner glass if you encounter print quality problems, such as streaks on copied or scanned images.

- 1 Slightly dampen a soft, lint-free cloth or paper towel with water.
- 2 Open the scanner cover.



- 3 Clean all the areas shown, and then let them dry.



1	White underside of the ADF cover
2	White underside of the scanner cover
3	Scanner glass
4	ADF glass

- 4 Close the scanner cover.

## Checking the status of parts and supplies

### Checking the status of parts and supplies on the printer control panel

From the home screen, navigate to:

**Status/Supplies > View Supplies**

### Checking the status of parts and supplies from the Embedded Web Server

**Note:** Make sure the computer and the printer are connected to the same network.

- 1 Open a Web browser, and then type the printer IP address in the address field.

**Notes:**

- View the printer IP address on the home screen. The IP address appears as four sets of numbers separated by periods, such as 123.123.123.123.
- If you are using a proxy server, then temporarily disable it to load the Web page correctly.

- 2 Click **Device Status > More Details**.

## Estimated number of remaining pages

The estimated number of remaining pages is based on the recent printing history of the printer. Its accuracy may vary significantly and is dependent on many factors, such as actual document content, print quality settings, and other printer settings.

The accuracy of the estimated number of remaining pages may decrease when the actual printing consumption is different from the historical printing consumption. Consider the variable level of accuracy before purchasing or replacing supplies based on the estimate. Until an adequate print history is obtained on the printer, initial estimates assume future supplies consumption based on the International Organization for Standardization\* test methods and page content.

\* Average continuous black or composite CMY declared cartridge yield in accordance with ISO/IEC 19798.

## Ordering supplies

To order supplies in the U.S., contact Lexmark at 1-800-539-6275 for information about Lexmark authorized supplies dealers in your area. In other countries or regions, go to the Lexmark Web site at [www.lexmark.com](http://www.lexmark.com) or contact the place where you purchased the printer.

**Note:** All life estimates for printer supplies assume printing on letter- or A4-size plain paper.

## Using genuine Lexmark parts and supplies

Your Lexmark printer is designed to function best with genuine Lexmark supplies and parts. Use of third-party supplies or parts may affect the performance, reliability, or life of the printer and its imaging components. Use of third-party supplies or parts can affect warranty coverage. Damage caused by the use of third-party supplies or parts is not covered by the warranty. All life indicators are designed to function with Lexmark supplies and parts, and may deliver unpredictable results if third-party supplies or parts are used. Imaging component usage beyond the intended life may damage your Lexmark printer or its associated components.

## Ordering toner cartridges

### Notes:

- The estimated cartridge yield is based on the ISO/IEC 19798 standard.
- Extremely low print coverage for extended periods of time may negatively affect actual yield and may cause cartridge parts to fail prior to exhaustion of toner.

### Return Program cartridges

Item	United States and Canada	European Union (EU), European Economic Area (EEA), and Switzerland	Rest of the world
<b>Return Program toner cartridges</b>			
Black	801K	802K	808K
Cyan	801C	802C	808C
Magenta	801M	802M	808M
Yellow	801Y	802Y	808Y
<b>Standard Yield Return Program toner cartridges</b>			
Black	801SK	802SK	808SK
Cyan	801SC	802SC	808SC
Magenta	801SM	802SM	808SM
Yellow	801SY	802SY	808SY
<b>High Yield Return Program toner cartridges</b>			
Black	801HK	802HK	808HK
Cyan	801HC	802HC	808HC
For more information on countries located in a region, visit <a href="http://www.lexmark.com/regions">www.lexmark.com/regions</a> .			



Item	United States and Canada	European Union (EU), European Economic Area (EEA), and Switzerland	Rest of the world
Magenta	801HM	802HM	808HM
Yellow	801HY	802HY	808HY
<b>Extra High Yield Return Program toner cartridges</b>			
Black	801XK	802XK	808XK
Cyan	801XC	802XC	808XC
Magenta	801XM	802XM	808XM
Yellow	801XY	802XY	808XY
For more information on countries located in a region, visit <a href="http://www.lexmark.com/regions">www.lexmark.com/regions</a> .			

Item	Worldwide
<b>Standard Yield regular toner cartridges</b>	
Black	800S1
Cyan	800S2
Magenta	800S3
Yellow	800S4
<b>High Yield regular toner cartridges</b>	
Black	800H1
Cyan	800H2
Magenta	800H3
Yellow	800H4
<b>Extra High Yield regular toner cartridges</b>	
Black	800X1
Cyan	800X2
Magenta	800X3
Yellow	800X4
For more information on countries located in a region, visit <a href="http://www.lexmark.com/regions">www.lexmark.com/regions</a> .	

## Ordering imaging kits

Item	All countries and regions
Black imaging kit	700Z1
Color imaging kit	700Z5

## Ordering a maintenance kit

### Notes:

- Using certain types of paper may require more frequent replacement of the maintenance kit.
- The fuser and transfer module are included in the maintenance kit and can also be individually ordered and replaced, if necessary.
- To replace the maintenance kit, contact customer support at <http://support.lexmark.com> or your service representative.

Part name	Type	Supply number
Maintenance kit	115 V	40X7615
	220 V	40X7616
	100 V	40X7617

## Ordering a waste toner bottle

Item	All countries and regions
Waste toner bottle	C540X75G

## Storing supplies

Choose a cool, clean storage area for the printer supplies. Store supplies right side up in their original packing until you are ready to use them.

Do not expose supplies to:

- Direct sunlight
- Temperatures above 35°C (95°F)
- High humidity above 80%
- Salty air
- Corrosive gases
- Heavy dust

## Replacing supplies

### Replacing the waste toner bottle

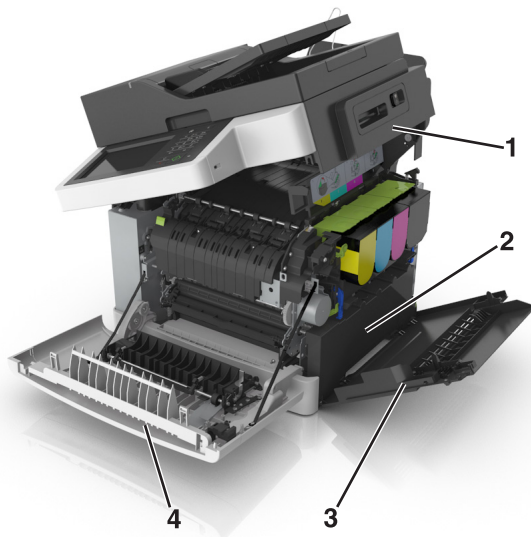

1	Top door
2	Waste toner bottle
3	Right side cover
4	Front door

1 Unpack the replacement waste toner bottle.

2 Open the front door.

 **CAUTION—HOT SURFACE:** The inside of the printer might be hot. To reduce the risk of injury from a hot component, allow the surface to cool before touching.

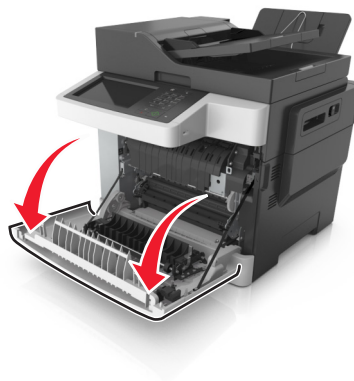

3 Open the top door.



4 Remove the right side cover.

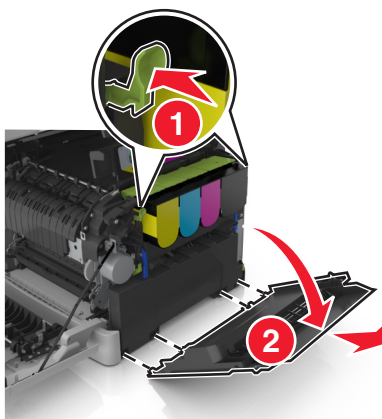

5 Press the green levers on each side of the waste toner bottle, and then remove the waste toner bottle.

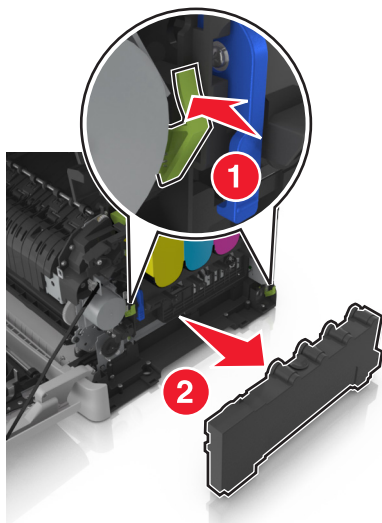

- 6 Seal the used waste toner bottle in the enclosed packaging.  
For more information, see [“Recycling Lexmark products” on page 199.](#)
- 7 Insert the replacement waste toner bottle.

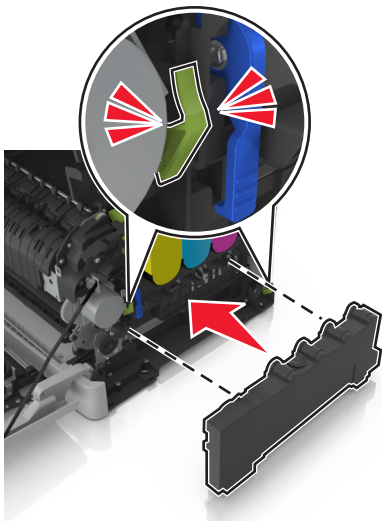

- 8 Insert the right side cover.

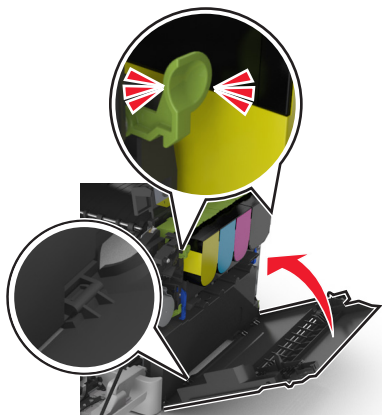

- Slide and hold the release latch on the right side of the printer, and then slowly close the top door.

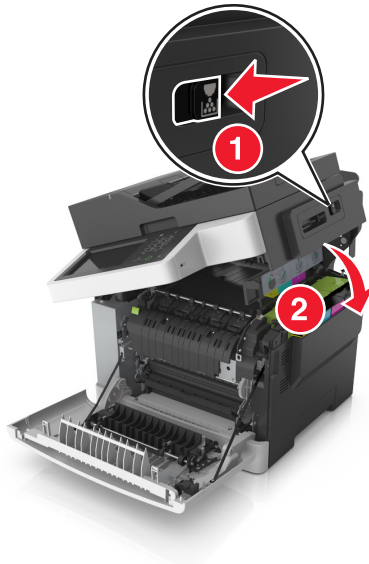

- Close the front door.

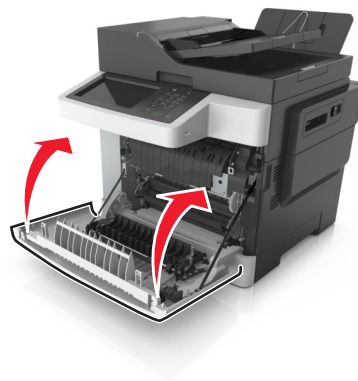

## Replacing a black and color imaging kit

- Open the front door.



**CAUTION—HOT SURFACE:** The inside of the printer might be hot. To reduce the risk of injury from a hot component, allow the surface to cool before touching.

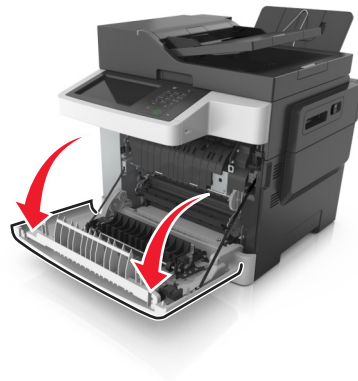

2 Open the top door.

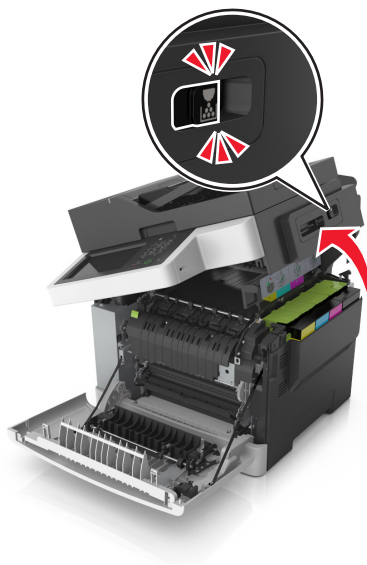

3 Remove the toner cartridges by lifting the handles, and then gently pulling them away from the imaging kit.

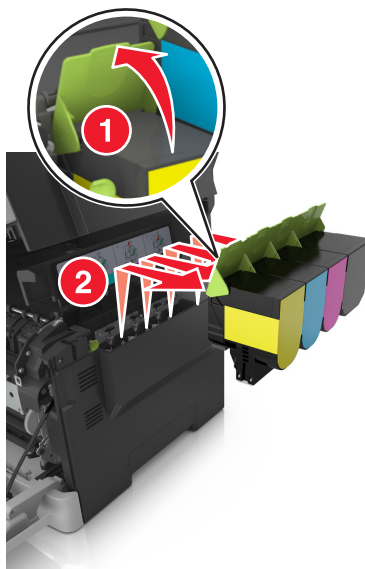

4 Remove the right side cover.

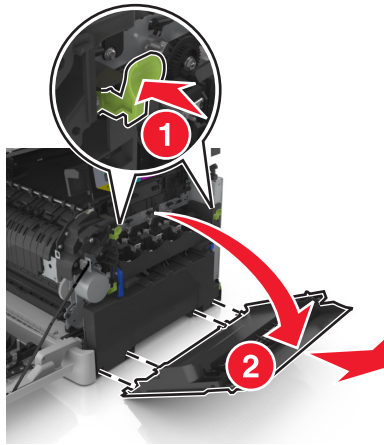

5 Press the green levers on each side of the waste toner bottle, and then remove the waste toner bottle.

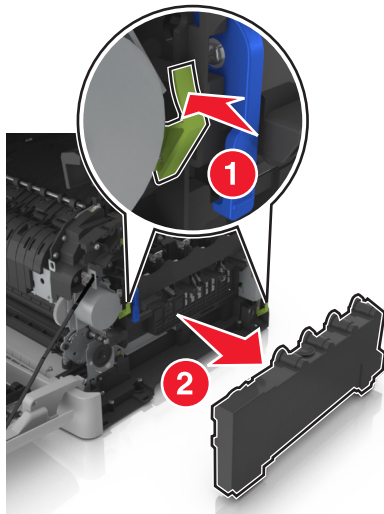

6 Lift the blue levers on the imaging kit, and then pull the imaging kit until it stops.

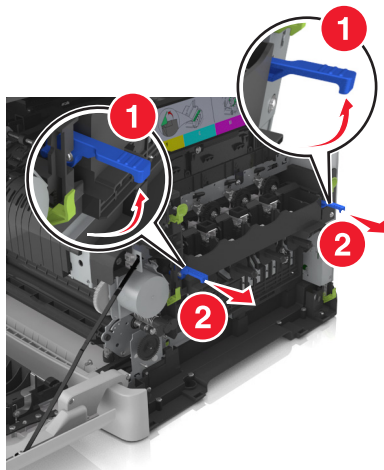



- 7 Press down the blue lever, and then grasp the green handles on the sides to pull out the imaging kit.

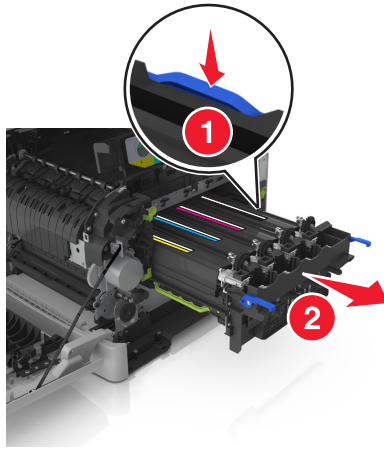

- 8 Unpack the replacement black and color imaging kit.

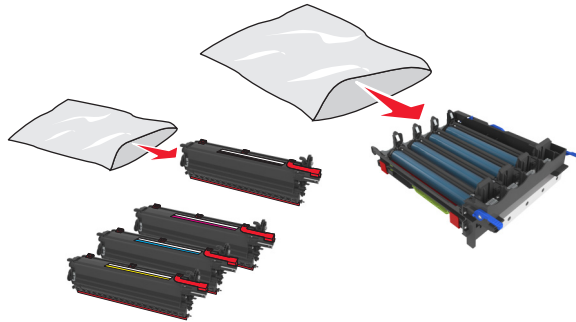

**Notes:**

- The color imaging kit includes the imaging kit and the cyan, magenta, yellow, and black developer units.
- The black imaging kit includes the imaging kit and the black developer unit.

- 9 Seal the used imaging kit in the bag that the replacement imaging kit came in.  
For more information, see [“Recycling Lexmark products” on page 199](#).

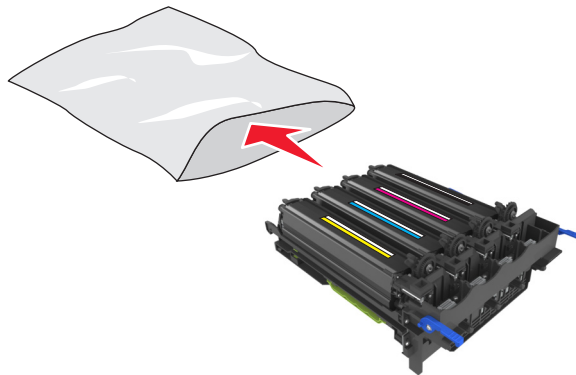

**Note:** When replacing the black imaging kit, save the cyan, magenta, and yellow developer units. Dispose only the black developer unit.

- 10** Gently shake the yellow, cyan, magenta, and black developer units side-to-side.

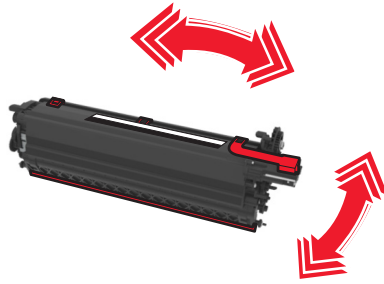

- 11** Remove the red packing strip and the attached fabric from the developer units.

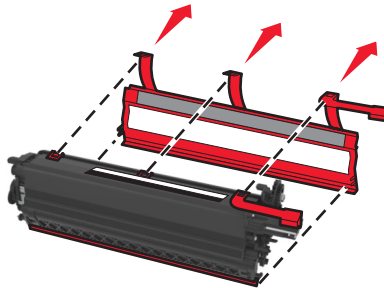

- 12** Gently insert the yellow, cyan, magenta, and black developer units.

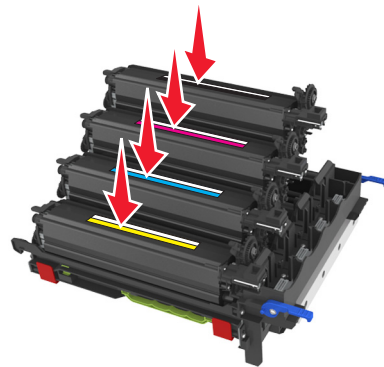

**Note:** Make sure each developer unit is inserted into the matching color slot.

- 13** Remove the red packing strip from the imaging kit.

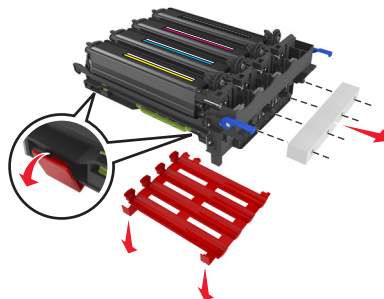

**Warning—Potential Damage:** Do not touch the shiny photoconductor drum under the imaging kit. Doing so may affect the quality of future print jobs.

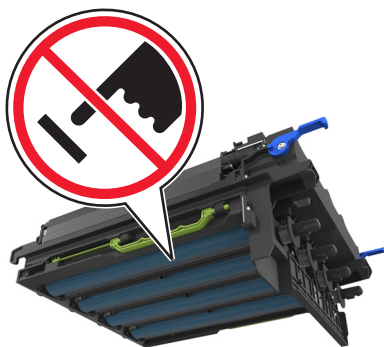

**14** Align and then insert the imaging kit.

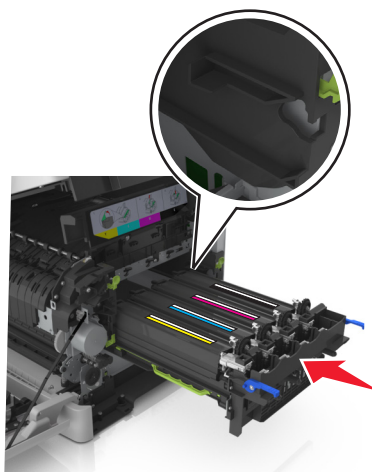

**15** Gently but firmly push the blue levers down until the imaging kit fits into place.

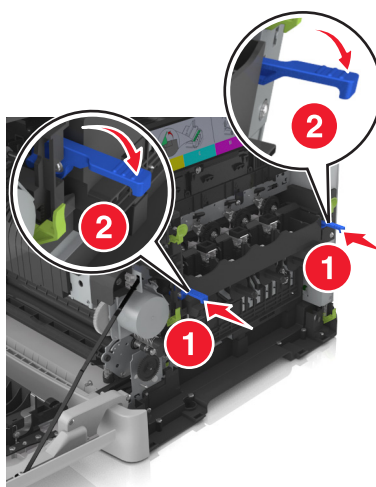

**Note:** Make sure that the imaging kit is fully seated.

**16** Insert the waste toner bottle.

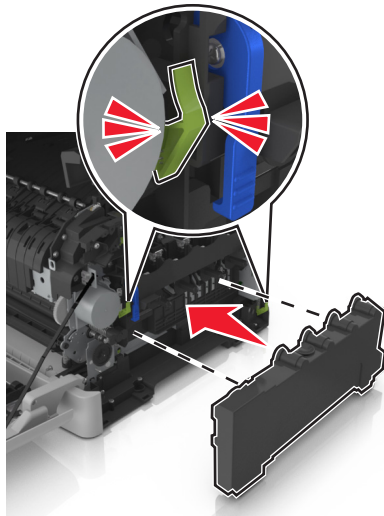

**17** Insert the right side cover.

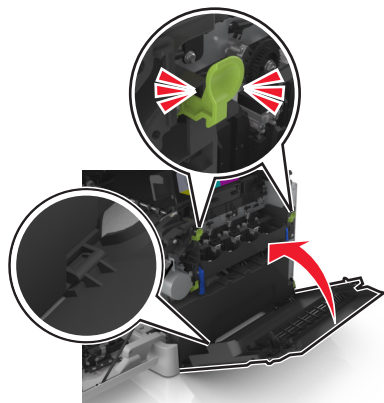

**18** Insert the toner cartridges.

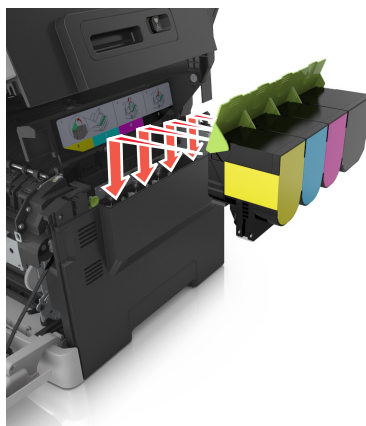

**19** Slide and hold the release latch on the right side of the printer, and then slowly close the top door.

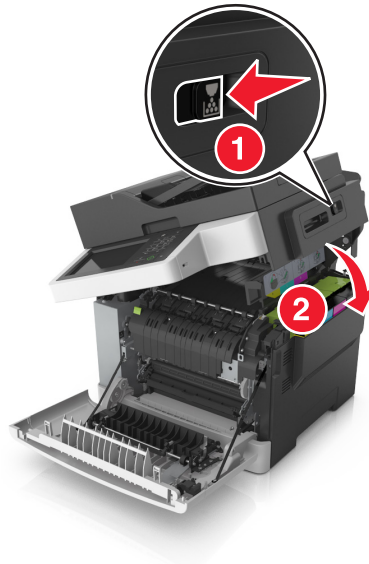

**20** Close the front door.

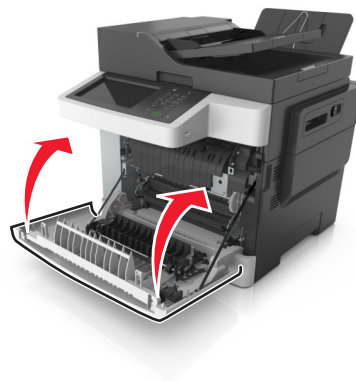

## Replacing toner cartridges

**Warning—Potential Damage:** Damage caused by use of a non-Lexmark toner cartridge is not covered under warranty.

**Note:** A reduced print quality may result from using non-Lexmark toner cartridges.

- 1 Open the top door.



- 2 Remove the toner cartridge by lifting the handle, and then gently pulling it away from the imaging kit.

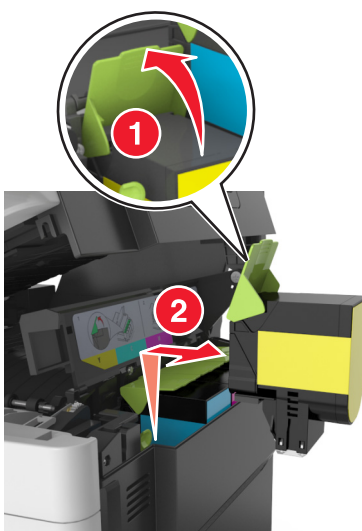

- 3 Unpack the new toner cartridge, and then remove its packaging.

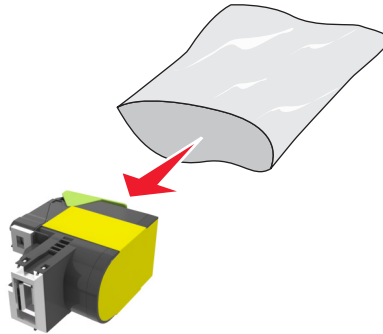

- 4 Align the new toner cartridge, and then press the cartridge down until it fits into place.

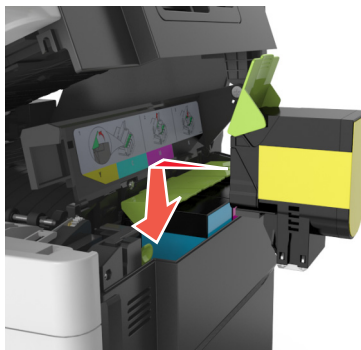

- 5 Slide and hold the release latch on the right side of the printer, and then slowly close the top door.

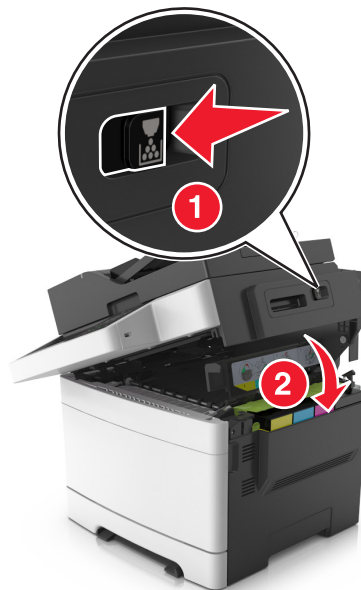

- 6 Seal the used toner cartridge in the bag that the replacement toner cartridge came in.  
For more information, see [“Recycling Lexmark products” on page 199](#).

## Replacing a developer unit

Replace the developer unit when a print quality defect occurs or when damage occurs to the printer.

- 1 Open the front door.

 **CAUTION—HOT SURFACE:** The inside of the printer might be hot. To reduce the risk of injury from a hot component, allow the surface to cool before touching.

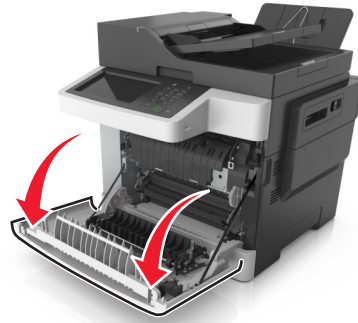

- 2 Open the top door.

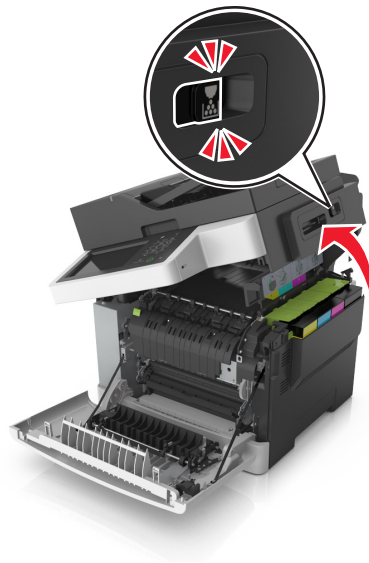



- 3 Lift the toner cartridge handle, and then gently pull it from the imaging kit.

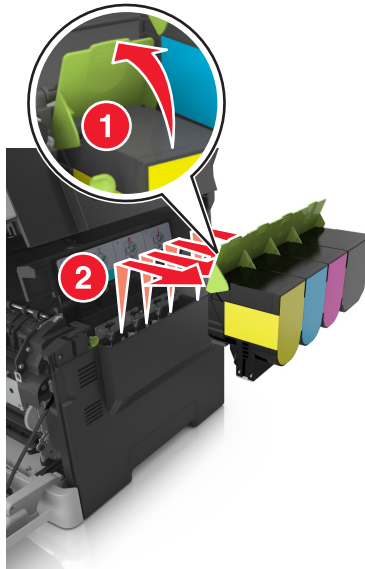

- 4 Remove the right side cover.

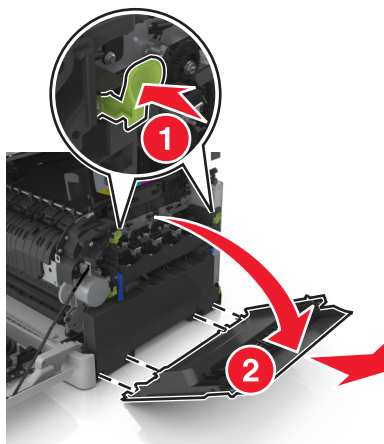

- 5 Press the green levers on each side of the waste toner bottle, and then remove the waste toner bottle.

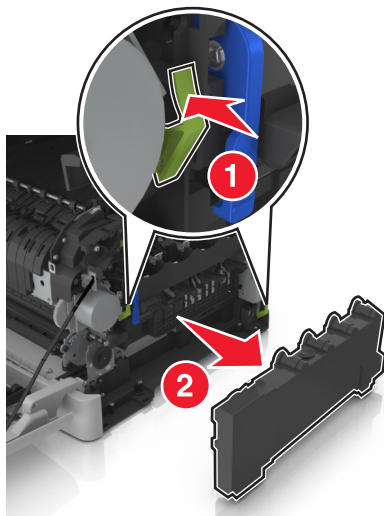

- 6 Lift the blue levers on the imaging kit, and then pull the imaging kit until it stops.

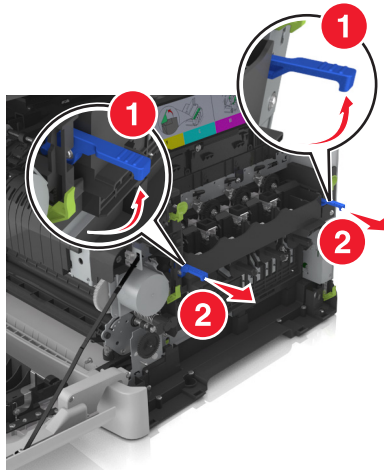

- 7 Press down the blue lever, and then grasp the green handles on the sides to pull out the imaging kit.

**Warning—Potential Damage:** Do not touch the underside of the imaging kit. Doing so could damage the imaging kit.

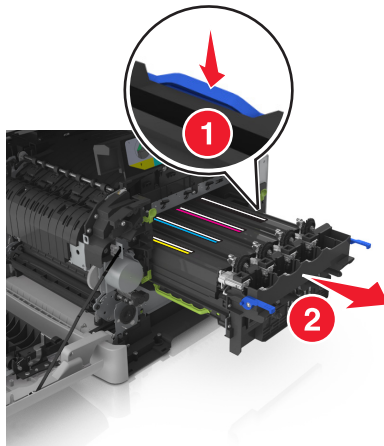

- 8 Remove the used developer unit.

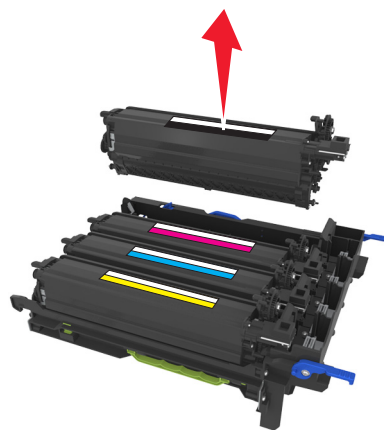

**9** Gently shake the replacement developer unit side-to-side before removing it from its packaging.

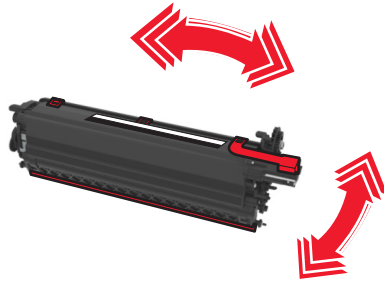

**10** Remove the red shipping cover from the developer unit.

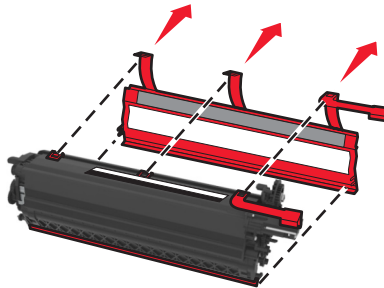

**11** Insert the developer unit.

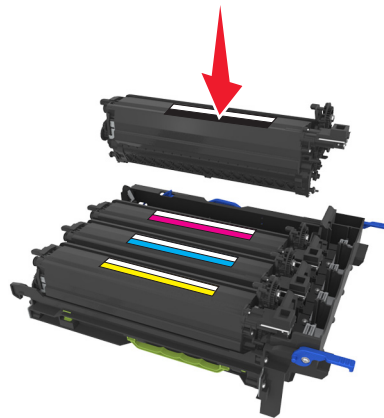

12 Align and then insert the imaging kit.

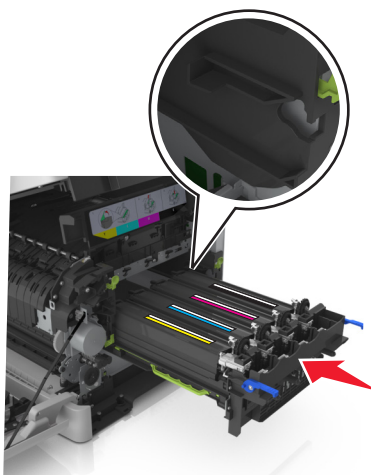

13 Gently but firmly push the blue levers down until the imaging kit fits into place.

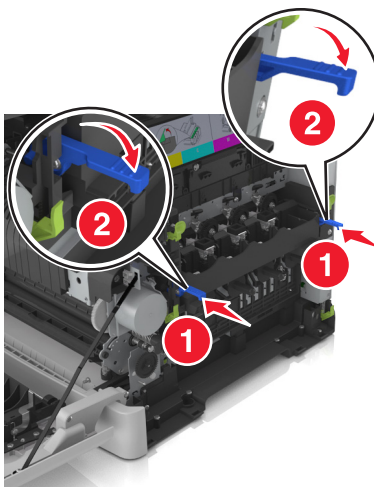

**Note:** Make sure that the imaging kit is fully seated.

14 Replace the waste toner bottle.

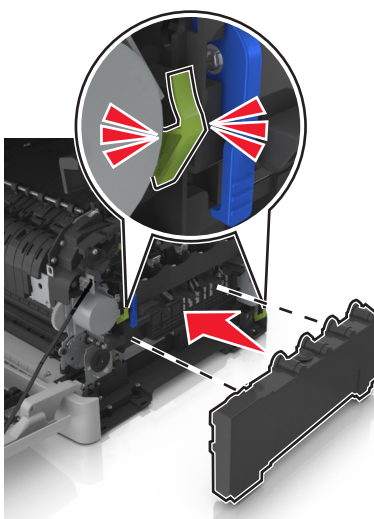

**15** Insert the right side cover.

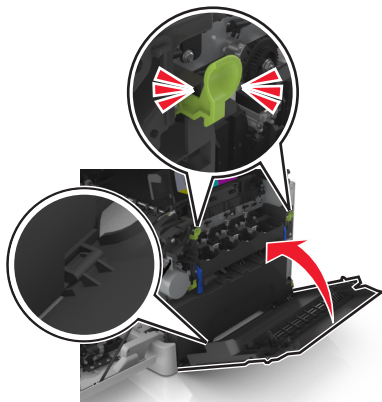

**16** Insert the toner cartridges.

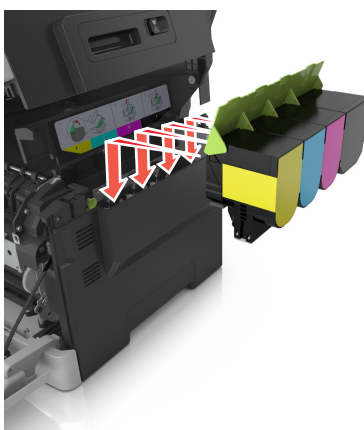

**17** Slide and hold the release latch on the right side of the printer, and then slowly close the top door.

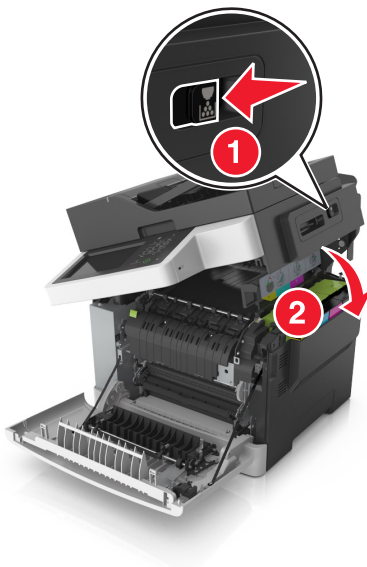

18 Close the front door.

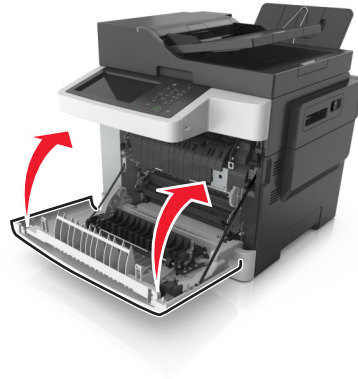

19 Seal the used developer unit in the bag that the replacement developer unit came in.

For more information, see [“Recycling Lexmark products” on page 199](#).

## Moving the printer

### Before moving the printer

**⚠ CAUTION—POTENTIAL INJURY:** The printer weight is greater than 18 kg (40 lb) and requires two or more trained personnel to lift it safely.

**⚠ CAUTION—POTENTIAL INJURY:** Before moving the printer, follow these guidelines to avoid personal injury or printer damage:

- Turn the printer off using the power switch, and then unplug the power cord from the electrical outlet.
- Disconnect all cords and cables from the printer before moving it.
- Lift the printer off the optional tray, and then set it aside instead of trying to lift the tray and printer at the same time.

**Note:** Use the handholds located on both sides of the printer to lift it.

**Warning—Potential Damage:** Damage to the printer caused by improper moving is not covered by the printer warranty.

### Moving the printer to another location

The printer and its hardware options can be safely moved to another location by following these precautions:

- Any cart used to move the printer must have a surface able to support the full footprint of the printer.
- Any cart used to move the hardware options must have a surface able to support the dimensions of the hardware options.
- Keep the printer in an upright position.
- Avoid severe jarring movements.

## **Shipping the printer**

When shipping the printer, use the original packaging.

# Managing the printer

## Finding advanced networking and administrator information

This chapter covers basic administrative support tasks using the Embedded Web Server. For more advanced system support tasks, see the *Networking Guide* on the *Software and Documentation CD* or the *Embedded Web Server — Security: Administrator's Guide* on the Lexmark support Web site at <http://support.lexmark.com>.

## Checking the virtual display

- 1 Open a Web browser, and then type the printer IP address in the address field.

### Notes:

- View the printer IP address in the TCP/IP section in the Network/Ports menu. The IP address appears as four sets of numbers separated by periods, such as 123.123.123.123.
- If you are using a proxy server, then temporarily disable it to load the Web page correctly.

- 2 Check the virtual display that appears at the top left corner of the screen.

The virtual display works as an actual display would work on a printer control panel.

## Setting up e-mail alerts

Configure the printer to send you e-mail alerts when the supplies are getting low or when the paper needs to be changed or added, or when there is a paper jam.

- 1 Open a Web browser, and then type the printer IP address in the address field.

### Notes:

- View the printer IP address on the printer home screen. The IP address appears as four sets of numbers separated by periods, such as 123.123.123.123.
- If you are using a proxy server, then temporarily disable it to load the Web page correctly.

- 2 Click **Settings**.

- 3 From the Other Settings menu, click **E-mail Alert Setup**.

- 4 Select the items you want to be notified on, and then type the e-mail addresses.

- 5 Click **Submit**.

**Note:** For information on setting up the e-mail server, contact your system support person.

## Viewing reports

You can view some reports from the Embedded Web Server. These reports are useful for assessing the status of the printer, network, and supplies.

- 1 Open a Web browser, and then type the printer IP address in the address field.



**Notes:**

- View the printer IP address on the printer home screen. The IP address appears as four sets of numbers separated by periods, such as 123.123.123.123.
- If you are using a proxy server, then temporarily disable it to load the Web page correctly.

**2** Click **Reports**, and then click the type of report you want to view.

## Configuring supply notifications from the Embedded Web Server

You can determine how you would like to be notified when supplies run nearly low, low, very low, or reach their end-of-life by setting the selectable alerts.

**Notes:**

- You can select alerts for toner cartridges, imaging kit, maintenance kit, and waste toner bottle.
- All alerts can be set for nearly low, low, and very low supply conditions. Not all alerts can be set for the end-of-life supply condition. E-mail alert is available for all supply conditions.
- The percentage of estimated remaining supply that prompts the alert can be set on some supplies for some supply conditions.

**1** Open a Web browser, and then type the printer IP address in the address field.

**Notes:**

- View the printer IP address in the TCP/IP section in the Network/Ports menu. The IP address appears as four sets of numbers separated by periods, such as 123.123.123.123.
- If you are using a proxy server, then temporarily disable it to load the Web page correctly.

**2** Click **Settings > Print Settings > Supply Notifications**.

**3** From the drop-down menu for each supply, select one of the following notification options:

Notification	Description
Off	The normal printer behavior for all supplies occurs.
E-mail Only	The printer generates an e-mail when the supply condition is reached. The status of the supply appears on the menus page and status page.
Warning	The printer shows the warning message and generates an email about the status of the supply. The printer does not stop when the supply condition is reached.
Continuable Stop <sup>1</sup>	The printer stops processing jobs when the supply condition is reached. The user needs to press a button to continue printing.
Non Continuable Stop <sup>1,2</sup>	The printer stops when the supply condition is reached. The supply must be replaced to continue printing.
<sup>1</sup> The printer generates an e-mail about the status of the supply when supply notification is enabled.	
<sup>2</sup> The printer stops when some supplies become empty to prevent damage.	

**4** Click **Submit**.

## Copying printer settings to other printers

**Note:** This feature is available only in network printers.

- 1 Open a Web browser, and then type the printer IP address in the address field.

**Notes:**

- View the printer IP address in the TCP/IP section in the Network/Ports menu. The IP address appears as four sets of numbers separated by periods, such as 123.123.123.123.
- If you are using a proxy server, then temporarily disable it to load the Web page correctly.

- 2 Click the **Copy Printer Settings**.

- 3 To change the language, select a language from the drop-down menu, and then click **Click here to submit language**.

- 4 Click **Printer Settings**.

- 5 Type the IP addresses of the source and target printers in their appropriate fields.

**Note:** If you want to add or remove a target printer, then click **Add Target IP** or **Remove Target IP**.

- 6 Click **Copy Printer Settings**.

## Restoring factory default settings

If you want to keep a list of the current menu settings for reference, then print a menu settings page before restoring the factory default settings. For more information, see [“Printing a menu settings page” on page 41](#).

If you want a more comprehensive method of restoring the printer factory default settings, then perform the Wipe All Settings option. For more information, see [“Erasing non-volatile memory” on page 202](#).

**Warning—Potential Damage:** Restoring factory defaults returns most printer settings to the original factory default settings. Exceptions include the display language, custom sizes and messages, and network/port menu settings. All downloads stored in the RAM are deleted. Downloads stored in the flash memory or in a printer hard disk are not affected.

From the home screen, navigate to:



> **Settings** > **General Settings** > **Factory Defaults** > **Restore Now** > **Submit**

# Clearing jams

## Avoiding jams

### Load paper properly

- Make sure paper lies flat in the tray.

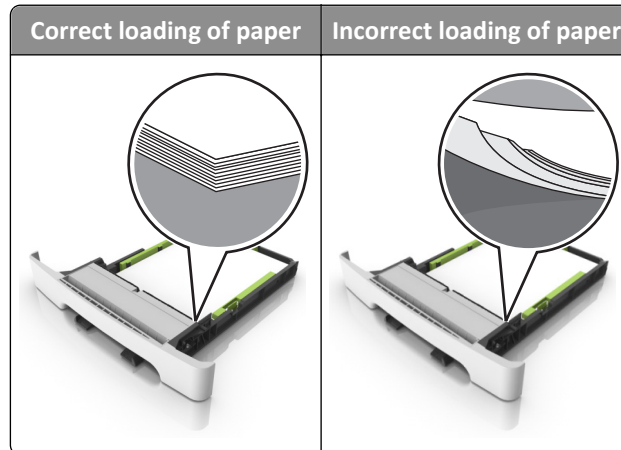

- Do not remove a tray while the printer is printing.
- Do not load a tray while the printer is printing. Load it before printing, or wait for a prompt to load it.
- Do not load too much paper. Make sure the stack height is below the maximum paper fill indicator.
- Do not slide the paper into the tray. Load paper as shown in the illustration.

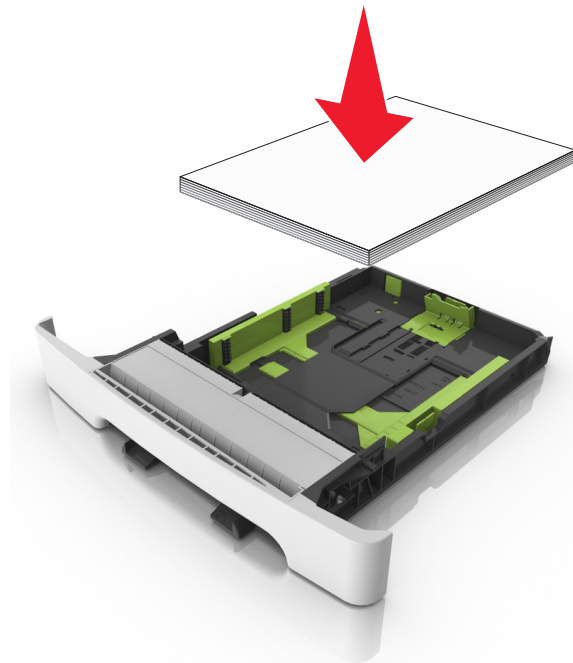

- Make sure the guides in the tray or the multipurpose feeder are properly positioned and are not pressing tightly against the paper or envelopes.
- Push the tray firmly into the printer after loading paper.

### Use recommended paper

- Use only recommended paper or specialty media.
- Do not load wrinkled, creased, damp, bent, or curled paper.
- Flex, fan, and straighten paper before loading it.

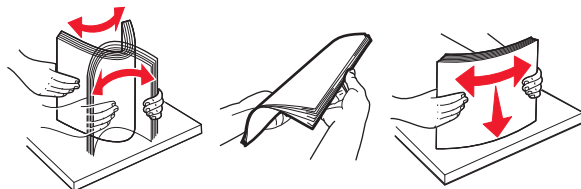

- Do not use paper that has been cut or trimmed by hand.
- Do not mix paper sizes, weights, or types in the same tray.
- Make sure the paper size and type are set correctly on the computer or printer control panel.
- Store paper per manufacturer recommendations.

## Understanding jam messages and locations

When a jam occurs, a message indicating the jam location and information to clear the jam appears on the printer display. Open the doors, covers, and trays indicated on the display to remove the jam.

**Note:** When Jam Recovery is set to On or Auto, the printer reprints jammed pages. However, Auto does not guarantee that the page will print.

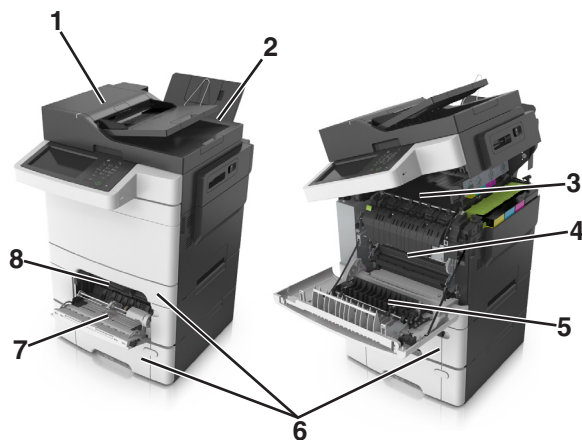

	Jam location	Message on the display	What to do
1	Automatic document feeder (ADF)	[x]-page jam, open automatic feeder top cover [28y.xx]	Remove all paper from the ADF tray, and then remove the jammed paper.
2	Standard bin	[x]-page jam, clear standard bin [203.xx]	Remove the jammed paper.

	Jam location	Message on the display	What to do
3	Fuser	[x]-page jam, open front door to clear fuser [202.xx]	Open the front door, then pull the tab and hold the fuser cover down, and then remove the jammed paper.
4	Front door	[x]-page jam, open front door [20y.xx]	Open the front door, and then remove the jammed paper.
5	Duplex area	[x]-page jam, open front door to clear duplex [23y.xx]	Open the front door, and then remove the jammed paper.
6	Tray [x]	[x]-page jam, open tray [x] [24y.xx]	Pull out the indicated tray, and then remove the jammed paper.
7	Multipurpose feeder	[x]-page jam, clear multipurpose feeder [250.xx]	Push the paper release lever to lift the paper rollers, and then remove the jammed paper.
8	Manual feeder	[x]-page jam, clear manual feeder [251.xx]	Remove the jammed paper.

## [x]-page jam, clear standard bin [203.xx]

- 1 Open the top door.



- 2 Firmly grasp the jammed paper on each side, and then gently pull it out.

**Note:** Make sure all paper fragments are removed.



**3** Open the front door.

 **CAUTION—HOT SURFACE:** The inside of the printer might be hot. To reduce the risk of injury from a hot component, allow the surface to cool before touching.

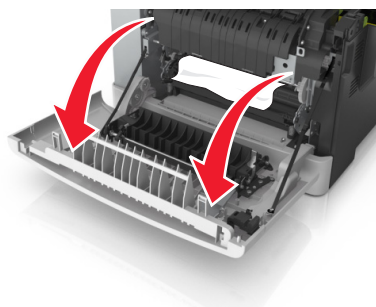

- a** If there is a jammed paper under the fuser, then firmly grasp the paper on each side, and then gently pull it out.

**Note:** Make sure all paper fragments are removed.

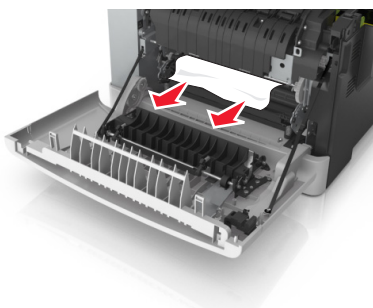

- b** Pull the green lever to open the fuser cover.

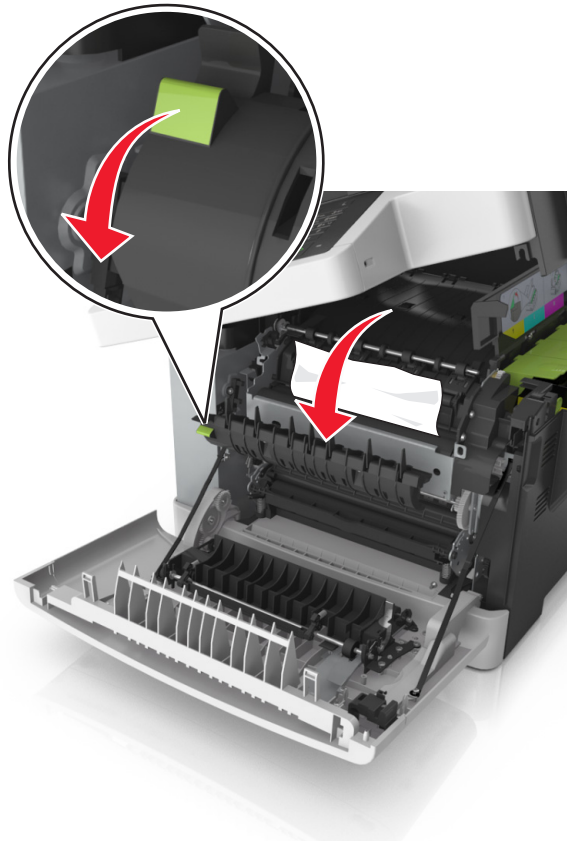

- c** If there is a jammed paper in the fuser, then hold down the fuser cover, and then remove the paper.

**Note:** Make sure all paper fragments are removed.

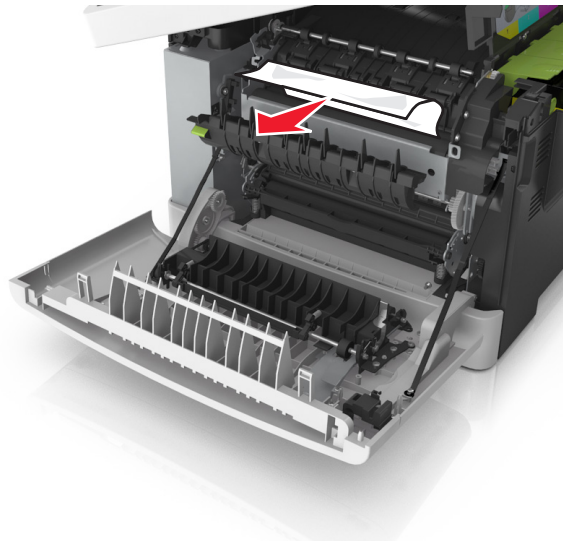

- Slide and hold the release latch on the right side of the printer, and then slowly close the top door.

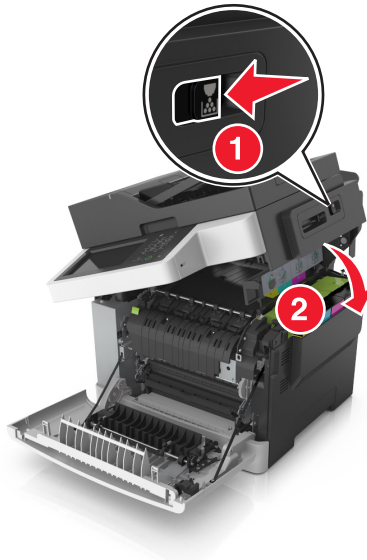

- Close the front door.

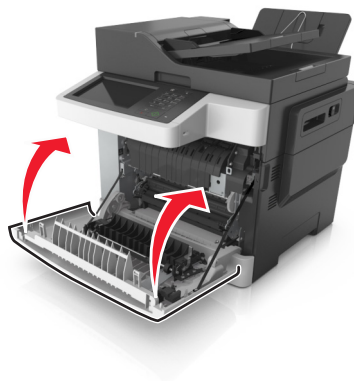

- From the printer control panel, touch **Done** to clear the message and continue printing.

## [x]-page jam, open front door to clear fuser [20y.xx]

- Open the front door.



**CAUTION—HOT SURFACE:** The inside of the printer might be hot. To reduce the risk of injury from a hot component, allow the surface to cool before touching.



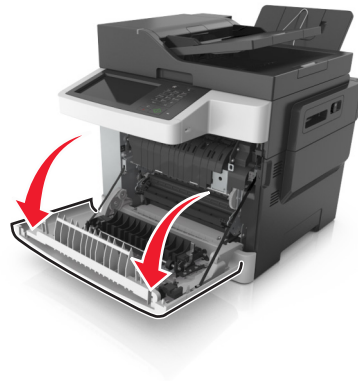

2 Open the top door.

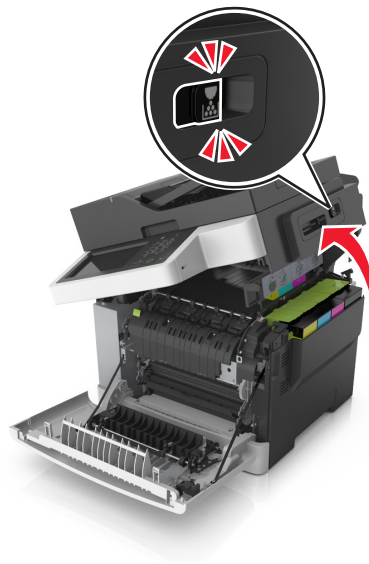

- 3 Pull the green lever to open the fuser cover.

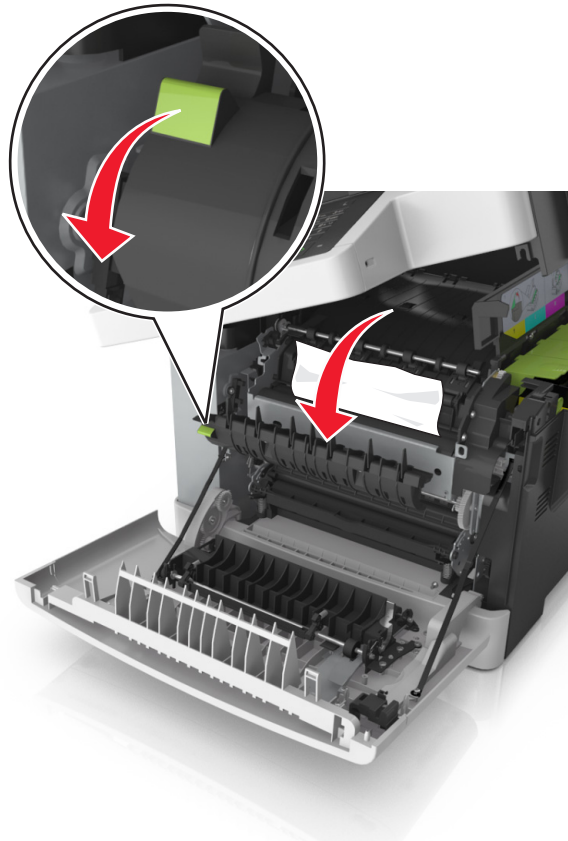

- 4 Hold down the fuser cover, and then remove the jammed paper.

**Note:** Make sure all paper fragments are removed.

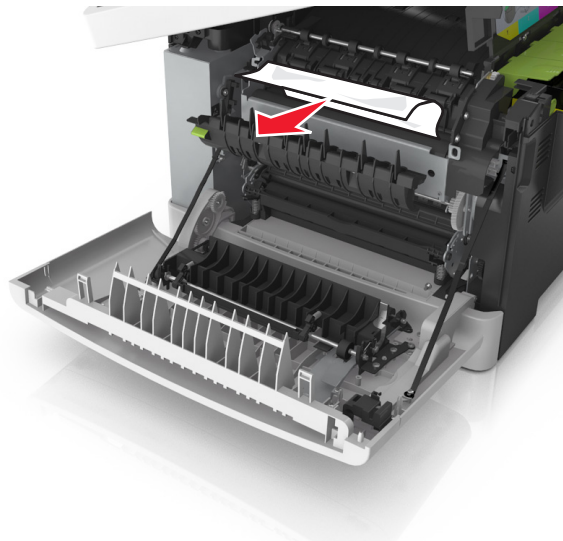

- 5 Slide and hold the release latch on the right side of the printer, and then slowly close the top door.

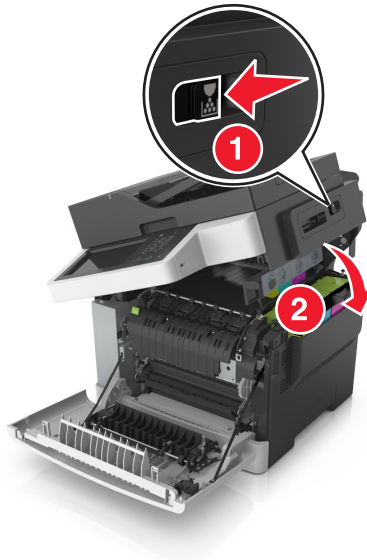

- 6 Close the front door.

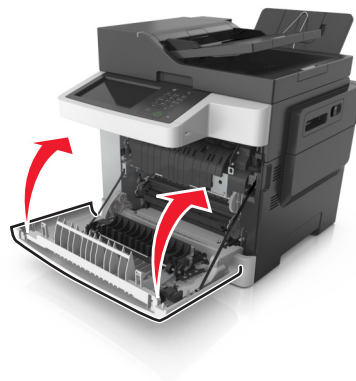

- 7 From the printer control panel, touch **Done** to clear the message and continue printing.

## [x]-page jam, open front door [20y.xx]

- 1 Open the front door.

 **CAUTION—HOT SURFACE:** The inside of the printer might be hot. To reduce the risk of injury from a hot component, allow the surface to cool before touching.

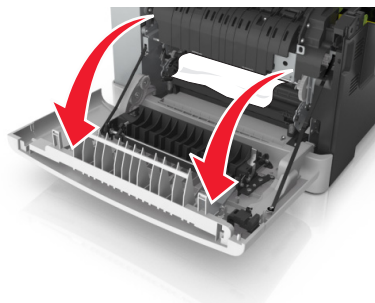

- 2 Firmly grasp the jammed paper on each side, and then gently pull it out.

**Note:** Make sure all paper fragments are removed.

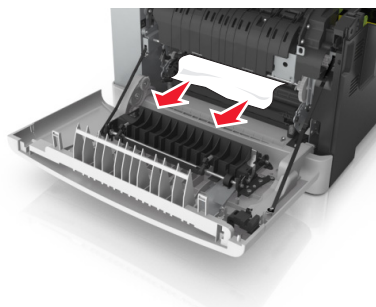

- 3 Close the front door.

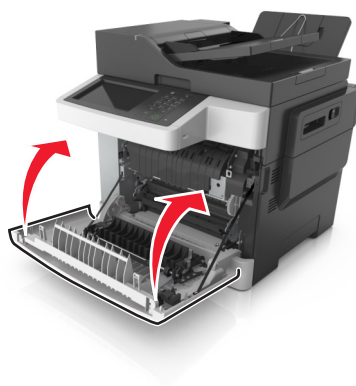

- 4 From the printer control panel, touch **Done** to clear the message and continue printing.

## [x]-page jam, open front door to clear duplex [23y.xx]

- 1 Open the front door.

 **CAUTION—HOT SURFACE:** The inside of the printer might be hot. To reduce the risk of injury from a hot component, allow the surface to cool before touching.

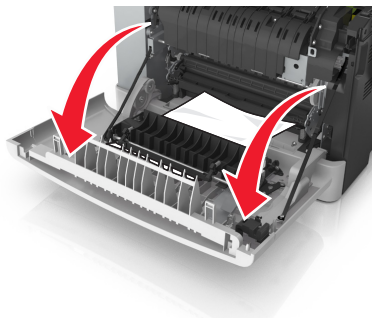

- 2 Firmly grasp the jammed paper on each side, and then gently pull it out.

**Note:** Make sure all paper fragments are removed.

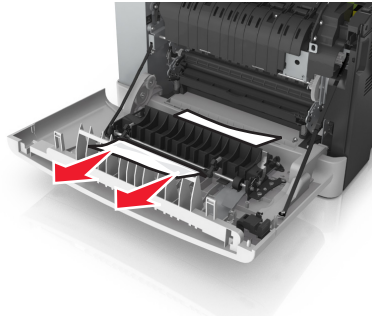

- 3 Close the front door.

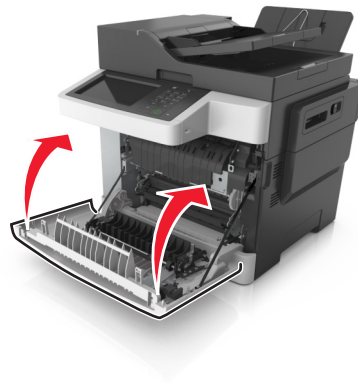

- 4 From the printer control panel, touch **Done** to clear the message and continue printing.

## [x]-page jam, open tray [x] [24y.xx]

- 1 Pull out the tray completely.

**Note:** The message on the printer display determines in which tray the paper jam is located.

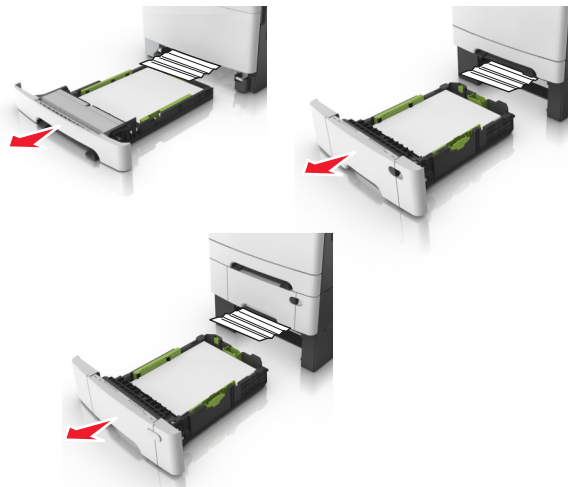

- 2 Firmly grasp the jammed paper on each side, and then gently pull it out.

**Note:** Make sure all paper fragments are removed.



3 Insert the tray.

4 From the printer control panel, touch **Done** to clear the message and continue printing.

## [x]-page jam, clear manual feeder [251.xx]

1 Pull out the standard 250-sheet tray (Tray 1) and manual feeder.

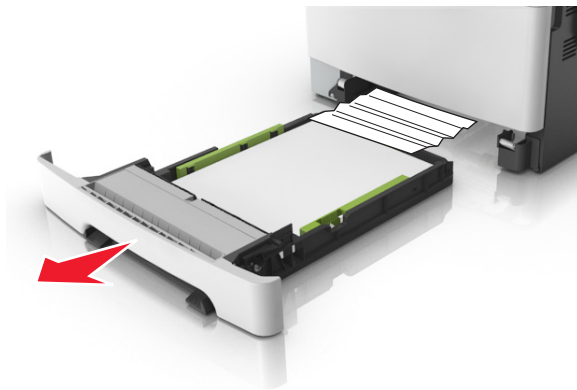

2 Firmly grasp the jammed paper on each side, and then gently pull it out.

**Note:** Make sure all paper fragments are removed.



3 Insert the tray.

4 From the printer control panel, touch **Done** to clear the message and continue printing.

## [x]-page jam, clear multipurpose feeder [250.xx]

1 Push the paper release lever in the multipurpose feeder to access the jammed paper, and then gently pull out the paper.

**Note:** Make sure all paper fragments are removed.

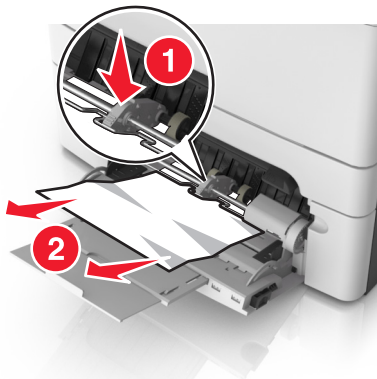

2 Flex the sheets of paper back and forth to loosen them, and then fan them. Do not fold or crease the paper. Straighten the edges on a level surface.

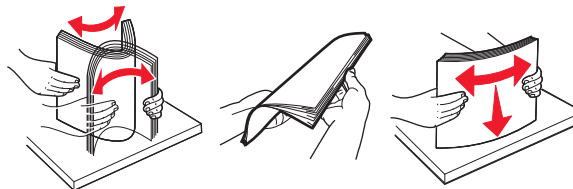

- 3 Reload paper into the multipurpose feeder.



- 4 Slide the paper guide until it lightly rests against the edge of the paper stack.

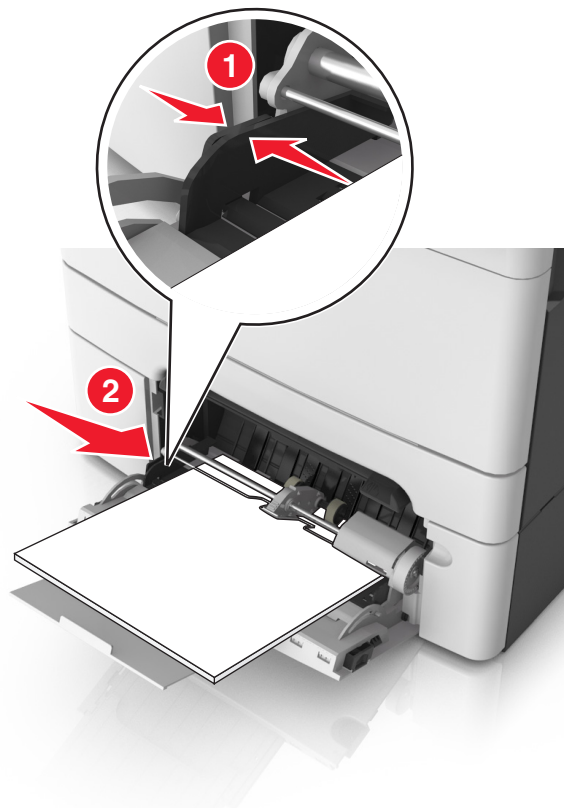

- 5 From the printer control panel, touch **Done** to clear the message and continue printing.



## [x]-page jam, open automatic feeder top cover [28y.xx]

- 1 Remove all original documents from the ADF tray.

**Note:** The message is cleared when the pages are removed from the ADF tray.

- 2 Open the ADF cover.

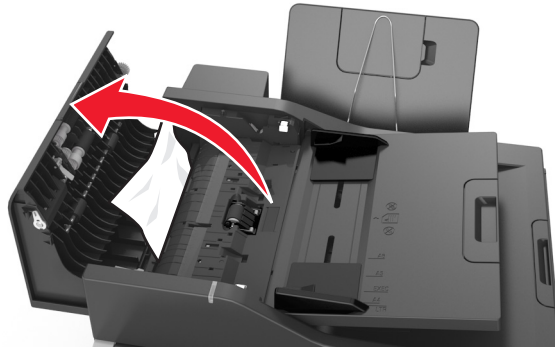

- 3 Firmly grasp the jammed paper on each side, and then gently pull it out.

**Note:** Make sure all paper fragments are removed.

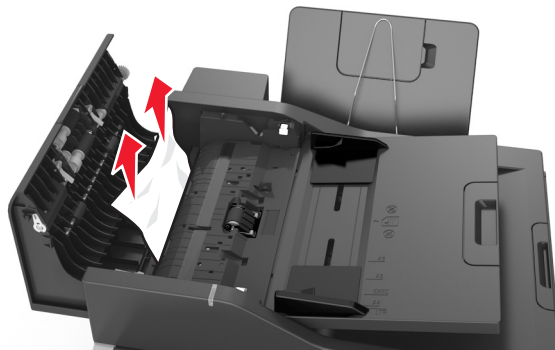

- 4 Close the ADF cover.

- 5 Straighten the edges of the original documents, then load the documents into the ADF, and then adjust the paper guide.

- 6 From the printer control panel, touch **Done** to clear the message and continue printing.

# Troubleshooting

## Understanding the printer messages

### Adjusting color

Wait for the process to complete.

### Change [paper source] to [custom string]

Try one or more of the following:

- Load the correct size and type of paper in the tray, and then touch **Finished changing paper** on the printer control panel.

**Note:** Make sure the paper size and type are specified in the Paper menu on the printer control panel.

- Cancel the print job.

### Change [paper source] to [custom type name]

Try one or more of the following:

- Load the correct size and type of paper in the tray or feeder, and then touch **Finished changing paper** on the printer control panel.

**Note:** Make sure the paper size and type are specified in the Paper menu on the printer control panel.

- Cancel the print job.

### Change [paper source] to [paper type] [paper size]

Try one or more of the following:

- Load the correct size and type of paper in the tray or feeder, and then touch **Finished changing paper** on the printer control panel.

**Note:** Make sure the paper size and type are specified in the Paper menu on the printer control panel.

- Cancel the print job.

### Close door

Make sure the right side cover is installed, and then close the front and top doors to clear the message.

## Close flatbed cover and load originals if restarting job [2yy.xx]

Try one or more of the following:

- Touch **Scan from automatic feeder** to continue scanning from the ADF immediately after the last successful scan job.
- Touch **Scan from flatbed** to continue scanning from the scanner glass immediately after the last successful scan job.
- Touch **Finish job without further scanning** to end the last successful scan job.

**Note:** This does not cancel the scan job. All successfully scanned pages will be processed further for copying, faxing, or e-mailing.

- Touch **Cancel job** to clear the message and cancel the scan job.

## [Color] cartridge low [88.xy]

You may need to order a toner cartridge. If necessary, touch **Continue** on the printer control panel to clear the message and continue printing.

## [Color] cartridge nearly low [88.xy]

If necessary, touch **Continue** on the printer control panel to clear the message and continue printing.

## [Color] cartridge very low, [x] estimated pages remain [88.xy]

You may need to replace the toner cartridge very soon. For more information, see the “Replacing supplies” section of the *User’s Guide*.

If necessary, touch **Continue** on the printer control panel to clear the message and continue printing.

## Complex page, some data may not have printed [39]

Try one or more of the following:

- From the printer control panel, touch **Continue** to ignore the message and continue printing.
- Cancel current print job.
- Install additional printer memory.

## Configuration change, some held jobs were not restored [57]

Held jobs are invalidated because of the following possible changes in the printer:

- The printer firmware has been updated.
- The tray for the print job has been removed.
- The print job is sent from a flash drive that is no longer attached to the USB port.
- The printer hard disk contains print jobs that were stored when the hard disk was installed in a different printer model.

From the printer control panel, touch **Continue** to clear the message.

## Defective flash detected [51]

Try one or more of the following:

- Replace the defective flash memory card.
- From the printer control panel, touch **Continue** to ignore the message and continue printing.
- Cancel the current print job.

## Disk full [62]

Try one or more of the following:

- From the printer control panel, touch **Continue** to clear the message and continue processing.
- Delete fonts, macros, and other data stored in the printer hard disk.
- Install a printer hard disk with larger capacity.

**Note:** To install a printer hard disk, contact customer support at <http://support.lexmark.com> or your service representative.

## Disk must be formatted for use in this device

From the printer control panel, touch **Format disk** to format the printer hard disk and clear the message.

**Note:** Formatting deletes all the files stored in the printer hard disk.

## Error reading USB drive. Remove USB.

An unsupported USB device is inserted. Remove the USB device, and then insert a supported one.

## Error reading USB hub. Remove hub.

An unsupported USB hub has been inserted. Remove the USB hub, and then install a supported one.

## Fax partition inoperative. Contact system administrator.

Try one or more of the following:

- From the printer control panel, touch **Continue** to clear the message.
- Turn off the printer, and then turn it back on. If the message appears again, then contact your system support person.

## Fax server 'To Format' not set up. Contact system administrator.

Try one or more of the following:

- From the printer control panel, touch **Continue** to clear the message.
- Complete the Fax Server setup. If the message appears again, then contact your system support person.

## **Fax Station Name not set up. Contact system administrator.**

Try either of the following:

- From the printer control panel, touch **Continue** to clear the message.
- Complete the Analog Fax setup. If the message appears again after completing the setup, then contact your system support person.

## **Fax Station Number not set up. Contact system administrator.**

Try one or more of the following:

- From the printer control panel, touch **Continue** to clear the message.
- Complete the Analog Fax setup. If the message appears again after completing the setup, then contact your system support person.

## **Incompatible tray [x] [59]**

Remove, and then reinstall the indicated tray to clear the message.

## **Incorrect paper size, open [paper source] [34]**

Try one or more of the following:

- Load the correct size and type of paper in the tray, and then specify the paper size and type in the Paper menu on the printer control panel.
- Make sure the correct paper size and type are specified in Print Properties or the Print dialog settings.
- Check if the paper size is correctly set. For example, if MP Feeder Size is set to Universal, then make sure the paper is large enough for the data being printed.
- Check the length and width guides and make sure the paper is loaded properly in the tray.
- From the printer control panel, touch **Continue** to clear the message and print using a different tray.
- Cancel the print job.

## **Insert Tray [x]**

Insert the indicated tray into the printer.

## **Insufficient memory for Flash Memory Defragment operation [37]**

Try one or more of the following:

- From the printer control panel, touch **Continue** to stop the defragmentation and continue printing.
- Delete fonts, macros, and other data in the printer memory.
- Install additional printer memory.

## **Insufficient memory, some Held Jobs were deleted [37]**

From the printer control panel, touch **Continue** to clear the message.

## Insufficient memory to collate job [37]

Try one or more of the following:

- From the printer control panel, touch **Continue** to print the part of the job already stored and begin collating the rest of the print job.
- Cancel the current print job.

## Insufficient memory to support Resource Save feature [35]

Install additional printer memory or touch **Continue** to disable Resource Save, clear the message, and continue printing.

## Insufficient memory, some held jobs will not be restored [37]

Try one or more of the following:

- From the printer control panel, touch **Continue** to clear the message.
- Delete other held jobs to free up additional printer memory.

## Load [paper source] with [custom string]

Try one or more of the following:

- Load the tray or feeder with the correct size and type of paper.
- To use the tray or feeder with the correct size and type of paper, touch **Finished loading paper** on the printer control panel.

**Note:** If the printer finds a tray or feeder that has the correct size and type of paper, then it feeds from that tray or feeder. If the printer cannot find a tray or feeder with the correct size and type of paper, then it prints from the default paper source.

- Cancel the current job.

## Load [paper source] with [custom type name]

Try one or more of the following:

- Load the tray or feeder with the correct size and type of paper.
- To use the tray or feeder with the correct size and type of paper, touch **Finished loading paper** on the printer control panel.

**Note:** If the printer detects a tray or feeder that has the correct size and type of paper, then it feeds from that tray or feeder. If the printer cannot detect a tray or feeder that has the correct size and type of paper, then it prints from the default paper source.

- Cancel the current job.

## Load [paper source] with [paper size]

Try one or more of the following:

- Load the tray or feeder with the correct size of paper.
- To use the tray or feeder with the correct size of paper, touch **Finished loading paper** on the printer control panel.

**Note:** If the printer finds a tray or feeder that has the correct size of paper, then it feeds from that tray or feeder. If the printer cannot find a tray or feeder with the correct size of paper, then it prints from the default paper source.

- Cancel the current job.

## Load [paper source] with [paper type] [paper size]

Try one or more of the following:

- Load the tray or feeder with the correct size and type of paper.
- To use the tray or feeder with the correct size and type of paper, touch **Finished loading paper** on the printer control panel.

**Note:** If the printer finds a tray or feeder that has the correct size and type of paper, then it feeds from that tray or feeder. If the printer cannot find a tray or feeder with the correct size and type of paper, then it prints from the default paper source.

- Cancel the current job.

## Load Manual Feeder with [custom string]

Try one or more of the following:

- Load the feeder with the correct size and type of paper.
- From the printer control panel, touch **Prompt each page, paper loaded** or **Do not prompt, paper loaded** to clear the message and continue printing.
- From the printer control panel, touch **Automatically select paper** to use the paper loaded in the tray.
- Cancel the print job.

## Load Manual Feeder with [custom type name]

Try one or more of the following:

- Load the feeder with the correct size and type of paper.
- From the printer control panel, touch **Prompt each page, paper loaded** or **Do not prompt, paper loaded** to clear the message and continue printing.
- From the printer control panel, touch **Automatically select paper** to use the paper loaded in the tray.
- Cancel the print job.

## Load Manual Feeder with [paper size]

Try one or more of the following:

- Load the feeder with the correct size of paper.
- From the printer control panel, touch **Prompt each page, paper loaded** or **Do not prompt, paper loaded** to clear the message and continue printing.
- From the printer control panel, touch **Automatically select paper** to use the paper loaded in the tray.
- Cancel the print job.

## Load Manual Feeder with [paper type] [paper size]

Try one or more of the following:

- Load the feeder with the correct size and type of paper.
- From the printer control panel, touch **Prompt each page, paper loaded** or **Do not prompt, paper loaded** to clear the message and continue printing.
- From the printer control panel, touch **Automatically select paper** to use the paper loaded in the tray.
- Cancel the print job.

## Maintenance kit low [80.xy]

You may need to order a maintenance kit. For more information, visit the Lexmark support Web site at <http://support.lexmark.com> or contact customer support, and then report the message.

If necessary, touch **Continue** to clear the message and continue printing.

## Maintenance kit nearly low [80.xy]

For more information, visit the Lexmark support Web site at <http://support.lexmark.com> or contact customer support, and then report the message.

If necessary, touch **Continue** to clear the message and continue printing.

## Maintenance kit very low, [x] estimated pages remain [80.xy]

You may need to replace the maintenance kit very soon. For more information, visit the Lexmark support Web site at <http://support.lexmark.com> or contact customer support, and then report the message.

If necessary, touch **Continue** to clear the message and continue printing.

## Memory full [38]

Try one or more of the following:

- From the printer control panel, touch **Cancel job** to clear the message.
- Install additional printer memory.



## Memory full, cannot print faxes

From the printer control panel, touch **Continue** to clear the message without printing. Held faxes attempt to print after the printer is restarted.

## Memory full, cannot send faxes

- 1 From the printer control panel, touch **Continue** to clear the message and cancel the fax job.
- 2 Try one or more of the following:
  - Reduce the fax resolution, and then resend the fax job.
  - Reduce the number of pages in the fax, and then resend the fax job.

## Network [x] software error [54]

Try one or more of the following:

- From the printer control panel, touch **Continue** to continue printing.
- Turn off the printer, wait for about 10 seconds, and then turn the printer back on.
- Update the network firmware in the printer or print server. For more information, visit the Lexmark support Web site at <http://support.lexmark.com>.

## No analog phone line connected to modem, fax is disabled.

Connect the printer to an analog phone line.

## Non-Lexmark [color] [supply type], see User's Guide [33.xy]

**Note:** The supply type can be a toner cartridge or the imaging kit.

The printer has detected a non-Lexmark supply or part installed in the printer.

Your Lexmark printer is designed to function best with genuine Lexmark supplies and parts. Use of third-party supplies or parts may affect the performance, reliability, or life of the printer and its imaging components.

All life indicators are designed to function with Lexmark supplies and parts, and may deliver unpredictable results if third-party supplies or parts are used. Imaging component usage beyond the intended life may damage your Lexmark printer or its associated components.

**Warning—Potential Damage:** Use of third-party supplies or parts can affect warranty coverage. Damage caused by the use of third-party supplies or parts may not be covered by the warranty.

To accept any and all of these risks, and to proceed with the use of non-genuine supplies or parts in your printer, press and hold  and the # button on the printer control panel simultaneously for 15 seconds.

If you do not wish to accept these risks, then remove the third-party supply or part from your printer, and then install a genuine Lexmark supply or part.

**Note:** For the list of supported supplies, see the “Ordering supplies” section of the *User's Guide* or visit [www.lexmark.com](http://www.lexmark.com).

## Not enough free space in flash memory for resources [52]

Try one or more of the following:

- From the printer control panel, touch **Continue** to clear the message and continue printing.
- Delete fonts, macros, and other data stored in the flash memory.
- Install a flash memory card with larger capacity.

**Note:** Downloaded fonts and macros not previously stored in the flash memory are deleted.

## Printer had to restart. Last job may be incomplete.

From the printer control panel, touch **Continue** to clear the message and continue printing.

For more information, visit <http://support.lexmark.com> or contact customer support.

## Reinstall missing or unresponsive [color] cartridge [31.xy]

Try one or more of the following:

- Install the missing toner cartridge. For more information, see the “Replacing supplies” section of the *User’s Guide*.
- Remove the unresponsive cartridge, and then reinstall it.

**Note:** If the message appears after reinstalling the supply, then the cartridge may be defective. Replace the cartridge.

## Reinstall missing or unresponsive [type] imaging kit [31.xy]

**Note:** The type can be a black imaging kit, or a black and color imaging kit.

Try one or more of the following:

- Install the missing imaging kit. For more information, see the “Replacing supplies” section of the *User’s Guide*.
- Remove the unresponsive imaging kit, and then reinstall it.

**Note:** If the message appears after reinstalling the supply, then the imaging kit may be defective. Replace the imaging kit.

## Reload printed pages in Tray [x]

Try any of the following:

- From the printer control panel, touch **Continue** to clear the message and continue printing the second side of the sheet.
- Cancel the print job.

## Remove defective disk [61]

Remove and replace the defective printer hard disk.

**Note:** To replace the printer hard disk, contact customer support at <http://support.lexmark.com> or your service representative.

## Remove packaging material, [area name]

- 1 Remove any remaining packing material from the indicated location.
- 2 From the printer control panel, touch **Continue** to clear the message.

## Remove paper from standard output bin

Remove the paper stack from the standard bin.

## Replace all originals if restarting job.

Try one or more of the following:

- Touch **Cancel job** to clear the message and cancel the scan job.
- Touch **Scan from automatic feeder** to continue scanning from the ADF immediately after the last successful scan job.
- Touch **Scan from flatbed** to continue scanning from the scanner immediately after the last successful scan job.
- Touch **Finish job without further scanning** to end the last successful scan job.
- Touch **Restart job** to restart the scan job with the same settings from the previous scan job.

## Replace [color] cartridge, 0 estimated pages remain [88.xy]

Replace the indicated toner cartridge to clear the message and continue printing. For more information, see the instruction sheet that came with the supply.

**Note:** If you do not have a replacement cartridge, then see the “Ordering supplies” section of the *User’s Guide* or visit [www.lexmark.com](http://www.lexmark.com).

## Replace [color] cartridge, printer region mismatch [42.xy]

Install a toner cartridge that matches the region number of the printer. *x* indicates the value of the printer region. *y* indicates the value of the cartridge region. *x* and *y* can have the following values:

Region number	Region
0	Global
1	United States, Canada
2	European Union (EU), European Economic Area (EEA), Switzerland
8	Rest of the world
9	Invalid

### Notes:

- The *x* and *y* values represent **.xy** in the error code that appears on the printer control panel.
- The *x* and *y* values must match for printing to continue.

## Replace defective [type] imaging kit [31.xy]

**Note:** The type can be a black imaging kit, or a black and color imaging kit.

Replace the defective imaging kit to clear the message and continue printing. For more information, see the instruction sheet that came with the supply.

**Note:** If you do not have a replacement imaging kit, then see the “Ordering supplies” section of the *User’s Guide* or visit [www.lexmark.com](http://www.lexmark.com).

## Replace jammed originals if restarting job.

Try one or more of the following:

- Touch **Cancel job** to clear the message and cancel the scan job.
- Touch **Scan from automatic feeder** to continue scanning from the ADF immediately after the last successful scan job.
- Touch **Scan from flatbed** to continue scanning from the scanner immediately after the last successful scan job.
- Touch **Finish job without further scanning** to end the last successful scan job.
- Touch **Restart job** to restart the scan job with the same settings from the previous scan job.

## Replace maintenance kit, 0 estimated pages remain [80.xy]

The printer is scheduled for maintenance. For more information, visit the Lexmark support Web site at <http://support.lexmark.com> or contact your service representative, and then report the message.

## Replace missing [type] imaging kit [31.xy]

**Note:** The type can be a black imaging kit, or a black and color imaging kit.

Install the indicated imaging kit to clear the message. For more information, see the “Replacing supplies” section of the *User’s Guide*.

## Replace missing waste toner bottle [82.xy]

Install the missing waste toner bottle to clear the message. For more information, see the instruction sheet that came with the supply.

## Replace [type] imaging kit, 0 estimated pages remain [84.xy]

**Note:** The type can be a black imaging kit, or a black and color imaging kit.

Replace the indicated imaging kit to clear the message and continue printing. For more information, see the instruction sheet that came with the supply.

**Note:** If you do not have a replacement imaging kit, then see the “Ordering supplies” section of the *User’s Guide* or visit [www.lexmark.com](http://www.lexmark.com).

## Replace unsupported [color] cartridge [32.xy]

Remove the toner cartridge, and then install a supported one to clear the message.

**Note:** If you do not have a replacement cartridge, then see the “Ordering supplies” section of the *User’s Guide* or visit [www.lexmark.com](http://www.lexmark.com).

## Replace unsupported [type] imaging kit [32.xy]

**Note:** The type can be a black imaging kit, or a black and color imaging kit.

Remove the indicated imaging kit, and then install a supported one to clear the message.

**Note:** If you do not have a replacement imaging kit, then see the “Ordering supplies” section of the *User’s Guide* or visit [www.lexmark.com](http://www.lexmark.com).

## Replace waste toner bottle [82.xy]

Replace the waste toner bottle to clear the message.

## Restore held jobs?

Try one or more of the following:

- From the printer control panel, touch **Restore** to restore all held jobs stored in the printer hard disk.
- From the printer control panel, touch **Do not restore** if you do not want to restore any of the print jobs.

## Scanner automatic feeder cover open

Close the ADF cover.

## Scanner disabled by admin [840.01]

Print without the scanner, or contact your system support person.

## Scanner disabled. Contact system administrator if problem persists. [840.02]

Try one or more of the following:

- Touch **Continue with scanner disabled** to return to the home screen, and then contact your system support person.
- Touch **Reboot and automatically enable scanner** to cancel the job.

**Note:** This attempts to enable the scanner.

## Scanner jam, remove all originals from the scanner [2yy.xx]

Remove the jammed paper from the scanner.

## Scanner jam, remove jammed originals from the scanner [2yy.xx]

Remove the jammed paper from the scanner.

## SMTP server not set up. Contact system administrator.

From the printer control panel, touch **Continue** to clear the message.

**Note:** If the message appears again, then contact your system support person.

## Some held jobs were not restored

From the printer control panel, touch **Continue** to delete the indicated job.

**Note:** Held jobs that are not restored remain in the printer hard disk and are inaccessible.

## Standard network software error [54]

Try one or more of the following:

- From the printer control panel, touch **Continue** to continue printing.
- Turn off the printer, and then turn it back on.
- Update the network firmware in the printer or print server. For more information, visit the Lexmark support Web site at <http://support.lexmark.com> or contact customer support, and then report the message.

## Standard USB port disabled [56]

Try one or more of the following:

- From the printer control panel, touch **Continue** to clear the message.
- Enable the USB port. From the printer control panel, navigate to:  
**Network/Ports > USB Buffer > Auto**

**Note:** The printer discards any data received through the USB port.

## Supply needed to complete job

Try one or more of the following:

- From the printer control panel, touch **Prompt for supplies** to view all error messages that indicate what supplies are needed to continue processing the current job.
  - 1 Order the missing supply immediately.
  - 2 Install the supply. For more information, see the instruction sheet that came with the supply.
- Cancel the print job, then install the missing supply, and then resend the print job.

## Too many flash options installed [58]

- 1 Turn off the printer.
- 2 Unplug the power cord from the electrical outlet.

- 3 Remove the extra flash memory.
- 4 Connect the power cord to a properly grounded electrical outlet.
- 5 Turn the printer back on.

### Too many trays attached [58]

- 1 Turn off the printer.
- 2 Unplug the power cord from the electrical outlet.
- 3 Remove the extra trays.
- 4 Connect the power cord to a properly grounded electrical outlet.
- 5 Turn the printer back on.

### [Type] imaging kit low [84.xy]

**Note:** The type can be a black imaging kit, or a black and color imaging kit.

You may need to replace the imaging kit. If necessary, touch **Continue** on the printer control panel to clear the message and continue printing.

### [Type] imaging kit nearly low [84.xy]

**Note:** The type can be a black imaging kit, or a black and color imaging kit.

If necessary, touch **Continue** on the printer control panel to clear the message and continue printing.

### [Type] imaging kit very low, [x] estimated pages remain [84.xy]

**Note:** The type can be a black imaging kit, or a black and color imaging kit.

You may need to replace the imaging kit very soon. For more information, see the “Replacing supplies” section of the *User’s Guide*.

If necessary, touch **Continue** on the printer control panel to clear the message and continue printing.

### Unformatted flash detected [53]

Try one or more of the following:

- From the printer control panel, touch **Continue** to stop the defragmentation and continue printing.
- Format the flash memory.

**Note:** If the error message remains, then the flash memory may be defective and needs to be replaced.

### Waste toner bottle nearly full [82.xy]

You may need to order a waste toner bottle. If necessary, touch **Continue** on the printer control panel to clear the message and continue printing.

## Weblink server not set up. Contact system administrator.

An error occurred on the Weblink server, or the server is not configured properly. Touch **Continue** to clear the message. If the message appears again, contact your system support person.

## Solving printer problems

### Basic printer problems

#### Printer display is blank

Action	Yes	No
<p><b>Step 1</b> Press the Sleep button on the printer control panel.</p> <p>Does <b>Ready</b> appear on the printer display?</p>	The problem is solved.	Go to step 2.
<p><b>Step 2</b> Turn off the printer, then wait for about 10 seconds, and then turn the printer back on.</p> <p>Do <b>Please wait</b> and <b>Ready</b> appear on the printer display?</p>	The problem is solved.	Turn off the printer, and then contact <a href="#">customer support</a> .

#### The printer is not responding

Action	Yes	No
<p><b>Step 1</b> Make sure the printer is turned on.</p> <p>Is the printer turned on?</p>	Go to step 2.	Turn on the printer.
<p><b>Step 2</b> Check if the printer is in Sleep mode or Hibernate mode.</p> <p>Is the printer in Sleep mode or Hibernate mode?</p>	Press the Sleep button to wake the printer from Sleep mode or Hibernate mode.	Go to step 3.
<p><b>Step 3</b> Check if one end of the power cord is plugged into the printer and the other to a properly grounded electrical outlet.</p> <p>Is the power cord plugged into the printer and a properly grounded electrical outlet?</p>	Go to step 4.	Plug one end of the power cord into the printer and the other to a properly grounded electrical outlet.



Action	Yes	No
<p><b>Step 4</b> Check other electrical equipment plugged into the electrical outlet.</p> <p>Does other electrical equipment work?</p>	Unplug the other electrical equipment, and then turn on the printer. If the printer does not work, then reconnect the other electrical equipment.	Go to step 5.
<p><b>Step 5</b> Check if the cables connecting the printer and the computer are inserted in the correct ports.</p> <p>Are the cables inserted in the correct ports?</p>	Go to step 6.	<p>Make sure to match the following:</p> <ul style="list-style-type: none"> <li>• The USB symbol on the cable with the USB symbol on the printer</li> <li>• The appropriate Ethernet cable with the Ethernet port</li> </ul>
<p><b>Step 6</b> Make sure the electrical outlet is not turned off by a switch or breaker.</p> <p>Is the electrical outlet turned off by a switch or breaker?</p>	Turn on the switch or reset the breaker.	Go to step 7.
<p><b>Step 7</b> Check if the printer is plugged into any surge protectors, uninterruptible power supplies, or extension cords.</p> <p>Is the printer plugged into any surge protectors, uninterruptible power supplies, or extension cords?</p>	Connect the printer power cord directly to a properly grounded electrical outlet.	Go to step 8.
<p><b>Step 8</b> Check if one end of the printer cable is plugged into a port on the printer and the other to the computer, print server, option, or other network device.</p> <p>Is the printer cable securely attached to the printer and the computer, print server, option, or other network device?</p>	Go to step 9.	Connect the printer cable securely to the printer and the computer, print server, option, or other network device.
<p><b>Step 9</b> Make sure to install all hardware options properly and remove any packing material.</p> <p>Are all hardware options properly installed and all packing material removed?</p>	Go to step 10.	Turn off the printer, remove all packing materials, then reinstall the hardware options, and then turn on the printer.
<p><b>Step 10</b> Check if you have selected the correct port settings in the printer driver.</p> <p>Are the port settings correct?</p>	Go to step 11.	Use correct printer driver settings.

Action	Yes	No
<p><b>Step 11</b> Check the installed printer driver.</p> <p>Is the correct printer driver installed?</p>	Go to step 12.	Install the correct printer driver.
<p><b>Step 12</b> Turn off the printer, then wait for about 10 seconds, and then turn the printer back on.</p> <p>Is the printer working?</p>	The problem is solved.	Contact <a href="#">customer support</a> .

## Option problems

### Cannot detect internal option

Action	Yes	No
<p><b>Step 1</b> Turn off the printer, then wait for about 10 seconds, and then turn on the printer.</p> <p>Does the internal option operate correctly?</p>	The problem is solved.	Go to step 2.
<p><b>Step 2</b> Check if the internal option is properly installed in the controller board.</p> <ul style="list-style-type: none"> <li><b>a</b> Turn off the printer using the power switch, and then unplug the power cord from the electrical outlet.</li> <li><b>b</b> Make sure the internal option is installed in the appropriate connector in the controller board.</li> <li><b>c</b> Connect the power cord to the printer, then to a properly grounded electrical outlet, and then turn on the printer.</li> </ul> <p>Is the internal option properly installed in the controller board?</p>	Go to step 3.	Connect the internal option to the controller board.
<p><b>Step 3</b> Print a menu settings page, and then check to see if the internal option is listed in the Installed Features list.</p> <p>Is the internal option listed in the menu settings page?</p>	Go to step 4.	Reinstall the internal option.
<p><b>Step 4</b></p> <ul style="list-style-type: none"> <li><b>a</b> Check if the internal option is selected. It may be necessary to manually add the internal option in the printer driver to make it available for print jobs. For more information, see <a href="#">“Adding available options in the print driver” on page 37</a>.</li> <li><b>b</b> Resend the print job.</li> </ul> <p>Does the internal option operate correctly?</p>	The problem is solved.	Contact <a href="#">customer support</a> .

### Cannot detect memory card

Action	Yes	No
<p>Make sure the memory card is installed.</p> <p><b>a</b> Install the memory card. For more information, see <a href="#">“Installing a memory card” on page 29</a>.</p> <p><b>Note:</b> Check if the memory card is securely connected to the printer controller board.</p> <p><b>b</b> Print a menu settings page, and then check if the card is listed in the Installed Options list.</p> <p>Is the card listed in the Installed Options list?</p>	<p>The problem is solved.</p>	<p>Contact <a href="#">customer support</a>.</p>

### Tray problems

Action	Yes	No
<p><b>Step 1</b></p> <p><b>a</b> Pull out the tray, and then do one or more of the following:</p> <ul style="list-style-type: none"> <li>• Check for paper jams or misfeeds.</li> <li>• Check if the paper size indicators on the paper guides are aligned with the paper size indicators on the tray.</li> <li>• If you are printing on custom-size paper, then make sure that the paper guides rest against the edges of the paper.</li> <li>• Make sure the paper is below the maximum paper fill indicator.</li> <li>• Make sure paper lies flat in the tray.</li> </ul> <p><b>b</b> Check if the tray closes properly.</p> <p>Is the tray working?</p>	<p>The problem is solved.</p>	<p>Go to step 2.</p>
<p><b>Step 2</b></p> <p><b>a</b> Turn off the printer, then wait about 10 seconds, and then turn the printer back on.</p> <p><b>b</b> Resend the print job.</p> <p>Is the tray working?</p>	<p>The problem is solved.</p>	<p>Go to step 3.</p>
<p><b>Step 3</b></p> <p>Check if the tray is installed and recognized by the printer.</p> <p>Print a menu settings page, and then check if the tray is listed in the Installed Features list.</p> <p>Is the tray listed in the menu settings page?</p>	<p>Go to step 4.</p>	<p>Reinstall the tray. For more information, see the setup documentation that came with the tray.</p>

Action	Yes	No
<p><b>Step 4</b>                      Check if the tray is available in the printer driver.  <b>Note:</b> If necessary, manually add the tray in the printer driver to make it available for print jobs. For more information, see <a href="#">“Adding available options in the print driver” on page 37.</a></p> <p>Is the tray available in the printer driver?</p>	The problem is solved.	Contact <a href="#">customer support</a> .

## Paper feed problems

### Jammed pages are not reprinted

Action	Yes	No
<p>Turn on Jam Recovery.</p> <p><b>a</b> From the home screen, navigate to:</p> <p> &gt; <b>Settings</b> &gt; <b>General Settings</b> &gt; <b>Print Recovery</b></p> <p><b>b</b> From the Jam Recovery menu, touch the arrows to scroll to <b>On</b> or <b>Auto</b>.</p> <p><b>c</b> Touch <b>Submit</b>.</p> <p>Do pages reprint after a jam?</p>	The problem is solved.	Contact <a href="#">customer support</a> .

### Paper frequently jams

Action	Yes	No
<p><b>Step 1</b></p> <p><b>a</b> Pull out the tray, and then do one or more of the following:</p> <ul style="list-style-type: none"> <li>• Make sure paper lies flat in the tray.</li> <li>• Check if the paper size indicators on the paper guides are aligned with the paper size indicators on the tray.</li> <li>• Check if the paper guides are aligned against the edges of the paper.</li> <li>• Make sure the paper is below the maximum paper fill indicator.</li> <li>• Check if you are printing on a recommended paper size and type.</li> </ul> <p><b>b</b> Insert the tray properly.</p> <p>If jam recovery is enabled, then the print jobs will reprint automatically.</p> <p>Do paper jams still occur frequently?</p>	Go to step 2.	The problem is solved.

Action	Yes	No
<p><b>Step 2</b></p> <p><b>a</b> Load paper from a fresh package.</p> <p><b>Note:</b> Paper absorbs moisture due to high humidity. Store paper in its original wrapper until you use it.</p> <p><b>b</b> Resend the print job.</p> <p>Do paper jams still occur frequently?</p>	Go to step 3.	The problem is solved.
<p><b>Step 3</b></p> <p><b>a</b> Review the tips on avoiding jams. For more information, see <a href="#">“Avoiding jams” on page 235</a>.</p> <p><b>b</b> Follow the recommendations, and then resend the print job.</p> <p>Do paper jams still occur frequently?</p>	Contact <a href="#">customer support</a> .	The problem is solved.

**Paper jam message remains after jam is cleared**

Action	Yes	No
<p>Check the entire paper path for jammed paper.</p> <p><b>a</b> Remove any jammed paper.</p> <p><b>b</b> From the printer control panel, touch <b>Continue</b> to clear the message.</p> <p>Does the paper jam message remain?</p>	Contact <a href="#">customer support</a> .	The problem is solved.

# Solving print problems

## Printing problems

### Confidential and other held jobs do not print

**Note:** Confidential, Verify, Reserve, and Repeat print jobs may be deleted if the printer requires extra memory to process additional held jobs.

Action	Yes	No
<p><b>Step 1</b></p> <p>Open the held jobs folder on the printer display, and then verify that your print job is listed.</p> <p>Is your print job listed in the held jobs folder?</p>	Go to step 2.	Select one of the Print and Hold options, and then resend the print job. For more information, see <a href="#">“Printing confidential and other held jobs” on page 66.</a>
<p><b>Step 2</b></p> <p>The print job may contain a formatting error or invalid data.</p> <ul style="list-style-type: none"> <li>• Delete the print job, and then send it again.</li> <li>• For PDF files, generate a new PDF, and then print it again.</li> </ul> <p>If you are printing from the Internet, then the printer may be reading multiple job titles as duplicates and deleting all jobs except the first one.</p> <p><b>For Windows users</b></p> <ol style="list-style-type: none"> <li>Open the Print Properties folder.</li> <li>From the Print and Hold dialog, select the “Keep duplicate documents” check box.</li> <li>Enter a PIN number.</li> </ol> <p><b>For Macintosh users</b></p> <p>Save each print job, name each job differently, and then send the individual jobs to the printer.</p> <p>Does the job print?</p>	The problem is solved.	Go to step 3.
<p><b>Step 3</b></p> <p>Free up additional printer memory by deleting some of the held jobs.</p> <p>Does the job print?</p>	The problem is solved.	Add additional printer memory.

### Error message about reading the flash drive appears

Action	Yes	No
<p><b>Step 1</b> Check if the flash drive is inserted into the front USB port. <b>Note:</b> The flash drive will not work if it is inserted into the rear USB port.</p> <p>Is the flash drive inserted into the front USB port?</p>	Go to step 2.	Insert the flash drive into the front USB port.
<p><b>Step 2</b> Check if the indicator light on the printer control panel is blinking green. <b>Note:</b> A green blinking light indicates that the printer is busy.</p> <p>Is the indicator light blinking green?</p>	Wait until the printer is ready, then view the held jobs list, and then print the documents.	Go to step 3.
<p><b>Step 3</b> a Check for an error message on the display. b Clear the message.</p> <p>Does the error message still appear?</p>	Go to step 4.	The problem is solved.
<p><b>Step 4</b> Check if the flash drive is supported. For more information on tested and approved USB flash drives, see <a href="#">“Supported flash drives and file types” on page 65.</a></p> <p>Does the error message still appear?</p>	Go to step 5.	The problem is solved.
<p><b>Step 5</b> Check if the USB port is disabled by the system support person.</p> <p>Does the error message still appear?</p>	Contact <a href="#">customer support</a> .	The problem is solved.

### Incorrect characters print

Action	Yes	No
<p><b>Step 1</b> Make sure the printer is not in Hex Trace mode. <b>Note:</b> If <b>Ready Hex</b> appears on the printer display, then turn off the printer, and then turn it back on to deactivate Hex Trace mode.</p> <p>Is the printer in Hex Trace mode?</p>	Deactivate Hex Trace mode.	Go to step 2.
<p><b>Step 2</b> a From the printer control panel, select <b>Standard Network</b> or <b>Network [x]</b>, and then set SmartSwitch to On. b Resend the print job.</p> <p>Do incorrect characters print?</p>	Contact <a href="#">customer support</a> .	The problem is solved.

### Job prints from the wrong tray or on the wrong paper

Action	Yes	No
<p><b>Step 1</b></p> <p><b>a</b> Check if you are printing on paper that is supported by the tray.</p> <p><b>b</b> Resend the print job.</p> <p>Did the job print from the correct tray or on the correct paper?</p>	The problem is solved.	Go to step 2.
<p><b>Step 2</b></p> <p><b>a</b> From the Paper menu on the printer control panel, set the paper size and type to match the paper loaded in the tray.</p> <p><b>b</b> Resend the print job.</p> <p>Did the job print from the correct tray or on the correct paper?</p>	The problem is solved.	Go to step 3.
<p><b>Step 3</b></p> <p><b>a</b> Depending on your operating system, open Printing Preferences or the Print dialog, and then specify the paper type.</p> <p><b>b</b> Resend the print job.</p> <p>Did the job print from the correct tray or on the correct paper?</p>	The problem is solved.	Go to step 4.
<p><b>Step 4</b></p> <p><b>a</b> Check if the trays are not linked.</p> <p><b>b</b> Resend the print job.</p> <p>Did the job print from the correct tray or on the correct paper?</p>	The problem is solved.	Contact <a href="#">customer support</a> .

### Large jobs do not collate

Action	Yes	No
<p><b>Step 1</b></p> <p><b>a</b> From the Finishing menu on the printer control panel, set Collate to (1,2,3) (1,2,3).</p> <p><b>b</b> Resend the print job.</p> <p>Did the job print and collate correctly?</p>	The problem is solved.	Go to step 2.
<p><b>Step 2</b></p> <p><b>a</b> From the printer software, set Collate to (1,2,3) (1,2,3).</p> <p><b>Note:</b> Setting Collate to (1,1,1) (2,2,2) in the software overrides the setting in the Finishing menu.</p> <p><b>b</b> Resend the print job.</p> <p>Did the job print and collate correctly?</p>	The problem is solved.	Go to step 3.



Action	Yes	No
<p><b>Step 3</b> Reduce the complexity of the print job by eliminating the number and size of fonts, the number and complexity of images, and the number of pages in the job.</p> <p>Did the job print and collate correctly?</p>	The problem is solved.	Contact <a href="#">customer support</a> .

### Multiple-language PDF files do not print

Action	Yes	No
<p><b>Step 1</b></p> <p><b>a</b> Check if the print options for the PDF output are set to embed all fonts. For more information, see the documentation that came with Adobe Acrobat.</p> <p><b>b</b> Generate a new PDF file, and then resend the print job.</p> <p>Do the files print?</p>	The problem is solved.	Go to step 2.
<p><b>Step 2</b></p> <p><b>a</b> Open the document you want to print in Adobe Acrobat.</p> <p><b>b</b> Click <b>File &gt; Print &gt; Advanced &gt; Print As Image &gt; OK &gt; OK</b>.</p> <p>Do the files print?</p>	The problem is solved.	Contact <a href="#">customer support</a> .

### Printing slows down

**Notes:**

- When printing using narrow paper, the printer prints at a reduced speed to prevent damage to the fuser.
- The printer speed may be reduced if printing for long periods of time, or printing at elevated temperatures.

Action	Yes	No
<p>Place letter- or A4-size paper in the tray, and then resend the print job.</p> <p>Does the print speed increase?</p>	The problem is solved.	Contact <a href="#">customer support</a> .

### Print jobs do not print

Action	Yes	No
<p><b>Step 1</b></p> <p><b>a</b> From the document you are trying to print, open the Print dialog and check if you have selected the correct printer.</p> <p><b>Note:</b> If the printer is not the default printer, then you must select the printer for each document that you want to print.</p> <p><b>b</b> Resend the print job.</p> <p>Do the jobs print?</p>	The problem is solved.	Go to step 2.
<p><b>Step 2</b></p> <p><b>a</b> Check if the printer is plugged in and turned on, and if <b>Ready</b> appears on the printer display.</p> <p><b>b</b> Resend the print job.</p> <p>Do the jobs print?</p>	The problem is solved.	Go to step 3.
<p><b>Step 3</b></p> <p>If an error message appears on the printer display, then clear the message.</p> <p><b>Note:</b> The printer continues to print after clearing the message.</p> <p>Do the jobs print?</p>	The problem is solved.	Go to step 4.
<p><b>Step 4</b></p> <p><b>a</b> Check if the ports (USB, serial, or Ethernet) are working and if the cables are securely connected to the computer and the printer.</p> <p><b>Note:</b> For more information, see the setup documentation that came with the printer.</p> <p><b>b</b> Resend the print job.</p> <p>Do the jobs print?</p>	The problem is solved.	Go to step 5.
<p><b>Step 5</b></p> <p><b>a</b> Turn off the printer, then wait for about 10 seconds, and then turn the printer back on.</p> <p><b>b</b> Resend the print job.</p> <p>Do the jobs print?</p>	The problem is solved.	Go to step 6.
<p><b>Step 6</b></p> <p><b>a</b> Remove, and then reinstall the printer software. For more information, see <a href="#">“Installing the printer” on page 36</a>.</p> <p><b>Note:</b> The printer software is available at <a href="http://support.lexmark.com">http://support.lexmark.com</a>.</p> <p><b>b</b> Resend the print job.</p> <p>Do the jobs print?</p>	The problem is solved.	Contact <a href="#">customer support</a> .

### Print job takes longer than expected

Action	Yes	No
<p><b>Step 1</b> Change the environmental settings of the printer.</p> <ul style="list-style-type: none"> <li><b>a</b> From the printer control panel, navigate to: <b>Settings &gt; General Settings</b></li> <li><b>b</b> Select <b>Eco-Mode</b> or <b>Quiet Mode</b>, and then select <b>Off</b>.</li> </ul> <p><b>Note:</b> Disabling Eco-Mode or Quiet Mode may increase the consumption of energy or supplies, or both.</p> <p>Did the job print?</p>	The problem is solved.	Go to step 2.
<p><b>Step 2</b> Reduce the number and size of fonts, the number and complexity of images, and the number of pages in the print job, and then resend the job</p> <p>Did the job print?</p>	The problem is solved.	Go to step 3.
<p><b>Step 3</b></p> <ul style="list-style-type: none"> <li><b>a</b> Remove held jobs stored in the printer memory.</li> <li><b>b</b> Resend the print job.</li> </ul> <p>Did the job print?</p>	The problem is solved.	Go to step 4.
<p><b>Step 4</b></p> <ul style="list-style-type: none"> <li><b>a</b> Disable the Page Protect feature. From the printer control panel, navigate to: <b>Settings &gt; General Settings &gt; Print Recovery &gt; Page Protect &gt; Off</b></li> <li><b>b</b> Resend the print job.</li> </ul> <p>Did the job print?</p>	The problem is solved.	Go to step 5.
<p><b>Step 5</b></p> <ul style="list-style-type: none"> <li><b>a</b> Check if the cable connections to the printer and print server are secure. For more information, see the setup documentation that came with the printer.</li> <li><b>b</b> Resend the print job.</li> </ul> <p>Did the job print?</p>	The problem is solved.	Go to step 6.
<p><b>Step 6</b> Install additional printer memory, and then resend the print job.</p> <p>Did the job print?</p>	The problem is solved.	Contact <a href="#">customer support</a> .

### Tray linking does not work

**Notes:**

- The trays can detect paper length.
- The multipurpose feeder does not automatically detect the paper size. You must set the size from the Paper Size/Type menu.

Action	Yes	No
<p><b>Step 1</b></p> <p><b>a</b> Open the trays, and then check if they contain paper of the same size and type.</p> <ul style="list-style-type: none"> <li>• Check if the paper guides are in the correct positions for the size of the paper loaded in each tray.</li> <li>• Check if the paper size indicators on the paper guides are aligned with the paper size indicators on the tray.</li> </ul> <p><b>b</b> Resend the print job.</p> <p>Do the trays link correctly?</p>	The problem is solved.	Go to step 2.
<p><b>Step 2</b></p> <p><b>a</b> From the printer control panel, set the paper size and type in the Paper menu to match the paper loaded in the trays to be linked.</p> <p><b>Note:</b> The paper size and type must match for trays to be linked.</p> <p><b>b</b> Resend the print job.</p> <p>Do the trays link correctly?</p>	The problem is solved.	Contact <a href="#">customer support</a> .

### Unexpected page breaks occur

Action	Yes	No
<p>Increase the printing timeout.</p> <p><b>a</b> From the home screen, navigate to:</p> <p> &gt; <b>Settings</b> &gt; <b>General Settings</b> &gt; <b>Timeouts</b></p> <p><b>b</b> Increase the Print Timeout setting, and then touch <b>Submit</b>.</p> <p><b>c</b> Resend the print job.</p> <p>Did the file print correctly?</p>	The problem is solved.	Check the original file for manual page breaks.

## Print quality problems

### Characters have jagged or uneven edges

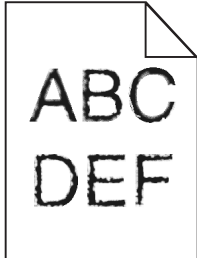

Action	Yes	No
<p><b>Step 1</b></p> <p><b>a</b> Print a font sample list to check if the fonts you are using are supported by the printer.</p> <ol style="list-style-type: none"> <li><b>1</b> From the printer control panel, navigate to: <b>Menus &gt; Reports &gt; Print Fonts</b></li> <li><b>2</b> Select <b>PCL Fonts</b> or <b>PostScript Fonts</b>.</li> </ol> <p><b>b</b> Resend the print job.</p> <p>Are you using fonts that are supported by the printer?</p>	Go to step 2.	Select a font that is supported by the printer.
<p><b>Step 2</b></p> <p>Check if the fonts installed on the computer are supported by the printer.</p> <p>Are the fonts installed on the computer supported by the printer?</p>	The problem is solved.	Contact <a href="#">customer support</a> .

### Clipped pages or images

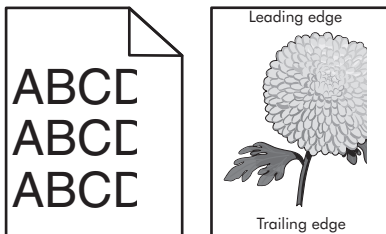

Action	Yes	No
<p><b>Step 1</b></p> <p><b>a</b> Move the width and length guides in the tray to the correct positions for the paper loaded.</p> <p><b>b</b> Resend the print job.</p> <p>Is the page or image clipped?</p>	Go to step 2.	The problem is solved.

Action	Yes	No
<p><b>Step 2</b></p> <p>From the printer control panel, set the paper size and type in the Paper menu to match the paper loaded in the tray.</p> <p>Does the paper size match the paper loaded in the tray?</p>	Go to step 3.	<p>Do one or more of the following:</p> <ul style="list-style-type: none"> <li>From the printer control panel, change the paper size to match the paper loaded in the tray.</li> <li>From the printer control panel, change the paper type to match the paper loaded in the tray.</li> </ul>
<p><b>Step 3</b></p> <p><b>a</b> Depending on your operating system, specify the paper size from Printing Preferences or from the Print dialog.</p> <p><b>b</b> Resend the print job.</p> <p>Is the page or image clipped?</p>	Go to step 4.	The problem is solved.
<p><b>Step 4</b></p> <p><b>a</b> Remove, and then reinstall the imaging kit.</p> <p><b>Warning—Potential Damage:</b> Do not expose the imaging kit to direct light for more than 10 minutes. Extended exposure to light may cause print quality problems.</p> <p><b>Warning—Potential Damage:</b> Do not touch the underside of the imaging kit. This could damage the imaging kit.</p> <p><b>b</b> Resend the print job.</p> <p>Is the page or image clipped?</p>	Contact <a href="#">customer support</a> .	The problem is solved.

**Gray background on prints**

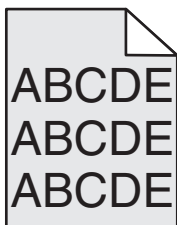

Action	Yes	No
<p><b>Step 1</b></p> <p>Reduce the toner darkness.</p> <p><b>a</b> From the Quality menu on the printer control panel, reduce the toner density.</p> <p><b>Note:</b> 4 is the factory default setting.</p> <p><b>b</b> Resend the print job.</p> <p>Did the gray background disappear?</p>	The problem is solved.	Go to step 2.
<p><b>Step 2</b></p> <p><b>a</b> Remove, and then reinstall the imaging kit.</p> <p><b>Warning—Potential Damage:</b> Do not expose the imaging kit to direct light for more than 10 minutes. Extended exposure to light may cause print quality problems.</p> <p><b>Warning—Potential Damage:</b> Do not touch the underside of the imaging kit. This could damage the imaging kit.</p> <p><b>b</b> Resend the print job.</p> <p>Did the gray background disappear?</p>	The problem is solved.	Contact <a href="#">customer support</a> .

### Horizontal voids appear on prints

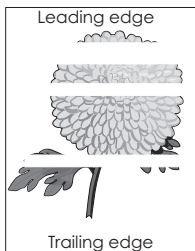

Action	Yes	No
<p><b>Step 1</b></p> <p><b>a</b> Make sure your software program is using a correct fill pattern.</p> <p><b>b</b> Resend the print job.</p> <p>Do horizontal voids appear on prints?</p>	Go to step 2.	The problem is solved.
<p><b>Step 2</b></p> <p><b>a</b> Load the specified tray or feeder with a recommended type of paper.</p> <p><b>b</b> Resend the print job.</p> <p>Do horizontal voids appear on prints?</p>	Go to step 3.	The problem is solved.

Action	Yes	No
<p><b>Step 3</b></p> <p><b>a</b> Remove, and then reinstall the imaging kit.</p> <p><b>Warning—Potential Damage:</b> Do not expose the imaging kit to direct light for more than 10 minutes. Extended exposure to light may cause print quality problems.</p> <p><b>Warning—Potential Damage:</b> Do not touch the underside of the imaging kit. This could damage the imaging kit.</p> <p><b>b</b> Resend the print job.</p> <p>Do horizontal voids appear on prints?</p>	Go to step 4.	The problem is solved.
<p><b>Step 4</b></p> <p>Replace the imaging kit, and then resend the print job.</p> <p>Do horizontal voids appear on prints?</p>	Contact <a href="#">customer support</a> .	The problem is solved.

**Incorrect margins on prints**

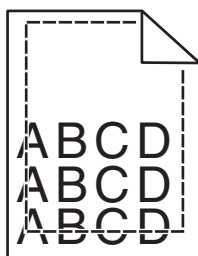

Action	Yes	No
<p><b>Step 1</b></p> <p><b>a</b> Move the width and length guides in the tray to the correct positions for the paper size loaded.</p> <p><b>b</b> Resend the print job.</p> <p>Are the margins correct?</p>	The problem is solved.	Go to step 2.
<p><b>Step 2</b></p> <p>From the printer control panel, set the paper size in the Paper menu to match the paper loaded in the tray.</p> <p>Does the paper size match the paper loaded in the tray?</p>	Go to step 3.	<p>Do one or more of the following:</p> <ul style="list-style-type: none"> <li>Specify the paper size from the tray settings to match the paper loaded in the tray.</li> <li>Change the paper loaded in the tray to match the paper size specified in the tray settings.</li> </ul>



Action	Yes	No
<p><b>Step 3</b></p> <p><b>a</b> Depending on your operating system, specify the paper size from Printing Preferences or from the Print dialog.</p> <p><b>b</b> Resend the print job.</p> <p>Are the margins correct?</p>	The problem is solved.	Contact <a href="#">customer support</a> .

### Paper curl

Action	Yes	No
<p><b>Step 1</b></p> <p>Move the width and length guides in the tray to the correct positions for the size of the paper loaded.</p> <p>Are the width and length guides positioned correctly?</p>	Go to step 2.	Adjust the width and length guides.
<p><b>Step 2</b></p> <p>From the printer control panel, set the paper type and weight in the Paper menu to match the paper loaded in the tray.</p> <p>Do the paper type and weight match the type and weight of the paper in the tray?</p>	Go to step 3.	Specify the paper type and weight from the tray settings to match the paper loaded in the tray.
<p><b>Step 3</b></p> <p><b>a</b> Depending on your operating system, specify the paper type and weight from Printing Preferences or from the Print dialog.</p> <p><b>b</b> Resend the print job.</p> <p>Is the paper still curled?</p>	Go to step 4.	The problem is solved.
<p><b>Step 4</b></p> <p><b>a</b> Remove the paper from the tray, and then turn it over.</p> <p><b>b</b> Resend the print job.</p> <p>Is the paper still curled?</p>	Go to step 5.	The problem is solved.
<p><b>Step 5</b></p> <p><b>a</b> Load paper from a fresh package.</p> <p><b>Note:</b> Paper absorbs moisture due to high humidity. Store paper in its original wrapper until you use it.</p> <p><b>b</b> Resend the print job.</p> <p>Is the paper still curled?</p>	Contact <a href="#">customer support</a> .	The problem is solved.

### Print irregularities

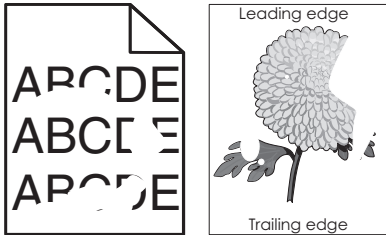

Action	Yes	No
<p><b>Step 1</b></p> <p><b>a</b> Move the width and length guides in the tray to the correct positions for the size of the paper loaded in the tray.</p> <p><b>b</b> Resend the print job.</p> <p>Do print irregularities still appear?</p>	Go to step 2.	The problem is solved.
<p><b>Step 2</b></p> <p>From the printer control panel, set the paper size and type in the Paper menu to match the paper loaded in the tray.</p> <p>Is the tray set to the size and type of the paper loaded in the tray?</p>	Go to step 3.	<p>Do one or more of the following:</p> <ul style="list-style-type: none"> <li>Specify the paper size from the tray settings to match the paper loaded in the tray.</li> <li>Change the paper loaded in the tray to match the paper size specified in the tray settings.</li> </ul>
<p><b>Step 3</b></p> <p><b>a</b> Depending on your operating system, specify the paper type and weight from Printing Preferences or from the Print dialog.</p> <p><b>b</b> Resend the print job.</p> <p>Do print irregularities still appear?</p>	Go to step 4.	The problem is solved.
<p><b>Step 4</b></p> <p>Check if the paper loaded in the tray has texture or rough finishes.</p> <p>Are you printing on textured or rough paper?</p>	From the printer control panel, set the paper texture in the Paper menu to match the paper loaded in the tray.	Go to step 5.
<p><b>Step 5</b></p> <p><b>a</b> Load paper from a fresh package.</p> <p><b>Note:</b> Paper absorbs moisture due to high humidity. Store paper in its original wrapper until you use it.</p> <p><b>b</b> Resend the print job.</p> <p>Do print irregularities still appear?</p>	Go to step 6.	The problem is solved.

Action	Yes	No
<p><b>Step 6</b>                      Replace the imaging kit, and then resend the print job.</p> <p>Do print irregularities still appear?</p>	<p>Contact <a href="#">customer support</a>.</p>	<p>The problem is solved.</p>

**Print is too dark**

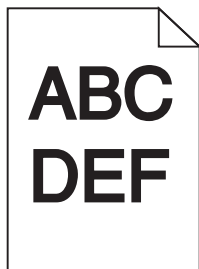

Action	Yes	No
<p><b>Step 1</b></p> <ul style="list-style-type: none"> <li><b>a</b> From the Quality menu on the printer control panel, select <b>Color Adjust</b>.</li> <li><b>b</b> Resend the print job.</li> </ul> <p>Is the print still too dark?</p>	<p>Go to step 2.</p>	<p>The problem is solved.</p>
<p><b>Step 2</b></p> <ul style="list-style-type: none"> <li><b>a</b> From the Quality menu on the printer control panel, reduce the toner darkness.  <b>Note:</b> 4 is the factory default setting.</li> <li><b>b</b> Resend the print job.</li> </ul> <p>Is the print still too dark?</p>	<p>Go to step 3.</p>	<p>The problem is solved.</p>
<p><b>Step 3</b></p> <ul style="list-style-type: none"> <li><b>a</b> From the printer control panel, set the paper type, texture, and weight in the Paper menu to match the paper loaded in the tray.</li> <li><b>b</b> Resend the print job.</li> </ul> <p>Is the tray set to the type, texture, and weight of the paper loaded?</p>	<p>Go to step 4.</p>	<p>Change the paper loaded in the tray to match the paper type, texture, and weight specified in the tray settings.</p>
<p><b>Step 4</b></p> <ul style="list-style-type: none"> <li><b>a</b> Depending on your operating system, specify the paper type, texture and weight from Printing Preferences or from the Print dialog.</li> <li><b>b</b> Resend the print job.</li> </ul> <p>Is the print still too dark?</p>	<p>Go to step 5.</p>	<p>The problem is solved.</p>

Action	Yes	No
<p><b>Step 5</b> Check if the paper loaded in the tray has texture or rough finishes.</p> <p>Are you printing on textured or rough paper?</p>	From the printer control panel, set the paper texture in the Paper menu to match the paper loaded on the tray.	Go to step 6.
<p><b>Step 6</b> a Load paper from a fresh package. <b>Note:</b> Paper absorbs moisture due to high humidity. Store paper in its original wrapper until you use it. b Resend the print job.</p> <p>Is the print still too dark?</p>	Go to step 7.	The problem is solved.
<p><b>Step 7</b> Replace the imaging kit, and then resend the print job.</p> <p>Is the print still too dark?</p>	Contact <a href="#">customer support</a> .	The problem is solved.

**Print is too light**

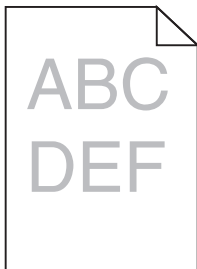

Action	Yes	No
<p><b>Step 1</b> a From the Quality menu on the printer control panel, select <b>Color Adjust</b>. b Resend the print job.</p> <p>Is the print still too light?</p>	Go to step 2.	The problem is solved.
<p><b>Step 2</b> a From the Quality menu on the printer control panel, increase the toner darkness. <b>Note:</b> 4 is the factory default setting. b Resend the print job.</p> <p>Is the print still too light?</p>	Go to step 3.	The problem is solved.

Action	Yes	No
<p><b>Step 3</b> From the printer control panel, set the paper type, texture, and weight in the Paper menu to match the paper loaded in the tray.</p> <p>Is the tray set to the type, texture, and weight of the paper loaded?</p>	Go to step 4.	Specify the paper type, texture, and weight from the tray settings to match the paper loaded in the tray.
<p><b>Step 4</b></p> <p><b>a</b> Depending on your operating system, specify the paper type, texture, and weight from Printing Preferences or from the Print dialog.</p> <p><b>b</b> Resend the print job.</p> <p>Is the print still too light?</p>	Go to step 5.	The problem is solved.
<p><b>Step 5</b> Make sure that the paper has no texture or rough finishes.</p> <p>Are you printing on textured or rough paper?</p>	From the printer control panel, set the paper texture in the Paper menu to match the paper loaded in the tray	Go to step 5.
<p><b>Step 6</b></p> <p><b>a</b> Load paper from a fresh package.</p> <p><b>Note:</b> Paper absorbs moisture due to high humidity. Store paper in its original wrapper until you use it.</p> <p><b>b</b> Resend the print job.</p> <p>Is the print still too light?</p>	Go to step 7.	The problem is solved.
<p><b>Step 7</b> Replace the imaging kit, and then resend the print job.</p> <p>Is the print still too light?</p>	Contact <a href="#">customer support</a> .	The problem is solved.

**Printer is printing blank pages**

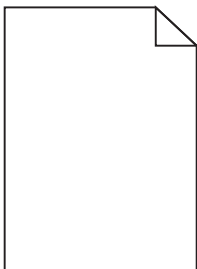

Action	Yes	No
<p><b>Step 1</b></p> <p><b>a</b> Check if there is packing material left on the imaging kit.</p> <p><b>1</b> Remove the imaging kit.</p> <p><b>2</b> Check if the packing material is properly removed from the imaging kit.</p> <p><b>Warning—Potential Damage:</b> Do not expose the imaging kit to direct light for more than 10 minutes. Extended exposure to light may cause print quality problems.</p> <p><b>Warning—Potential Damage:</b> Do not touch the underside of the imaging kit. This could damage the imaging kit.</p> <p><b>3</b> Reinstall the imaging kit.</p> <p><b>b</b> Resend the print job.</p> <p>Is the printer still printing blank pages?</p>	Go to step 2.	The problem is solved.
<p><b>Step 2</b></p> <p>Replace the imaging kit, and then resend the print job.</p> <p>Is the printer still printing blank pages?</p>	Contact <a href="#">customer support</a> .	The problem is solved.

### Printer is printing solid black pages



Action	Yes	No
<p><b>Step 1</b></p> <p><b>a</b> Remove, and then reinstall the imaging kit.</p> <p><b>Warning—Potential Damage:</b> Do not expose the imaging kit to direct light for more than 10 minutes. Extended exposure to light may cause print quality problems.</p> <p><b>Warning—Potential Damage:</b> Do not touch the underside of the imaging kit. This could damage the imaging kit.</p> <p><b>b</b> Resend the print job.</p> <p>Is the printer printing solid black pages?</p>	Go to step 2.	The problem is solved.
<p><b>Step 2</b></p> <p>Replace the imaging kit, and then resend the print job.</p> <p>Is the printer printing solid black pages?</p>	Contact <a href="#">customer support</a> .	The problem is solved.

### Repeating defects appear on prints

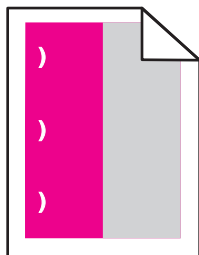

Action	Yes	No
<p><b>a</b> Check if the distance between the defects is equal to one of the following:</p> <ul style="list-style-type: none"> <li>• 25.1 mm (0.98 in.)</li> <li>• 29.8 mm (1.17 in.)</li> <li>• 43.9 mm (1.72 in.)</li> <li>• 45.5 mm (1.79 in.)</li> <li>• 94.2 mm (3.70 in.)</li> </ul> <p><b>b</b> If the distance between the defects equals 25.1 mm (0.98 in.), 29.8 mm (1.17 in.), or 94.2 mm (3.70 in.), then replace the photoconductor unit.</p> <p><b>c</b> If the distance between the defects equals 43.9 mm (1.72 in.) or 45.5 mm (1.79 in.), then replace the developer unit.</p> <p>Do the repeating defects still appear?</p>	<p><b>1</b> Check if the distance between the defects is equal to one of the following:</p> <ul style="list-style-type: none"> <li>• 37.7 mm (1.48 in.)</li> <li>• 78.5 mm (3.09 in.)</li> <li>• 95 mm (3.74 in.)</li> </ul> <p><b>2</b> Take note of the distance, and then contact <a href="#">customer support</a> or your service representative.</p>	<p>The problem is solved.</p>

### Shadow images appear on prints

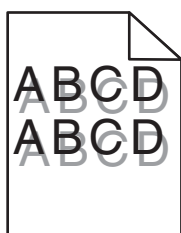

Action	Yes	No
<p><b>Step 1</b></p> <p>Check if the paper loaded in the tray has the correct paper type and weight.</p> <p>Is paper with the correct paper type and weight loaded in the tray?</p>	<p>Go to step 2.</p>	<p>Load paper with the correct paper type and weight in the tray.</p>
<p><b>Step 2</b></p> <p>From the printer control panel, set the paper type and weight in the Paper menu to match the paper loaded in the tray.</p> <p>Do the printer settings match the type and weight of the paper loaded?</p>	<p>Go to step 3.</p>	<p>Change the paper type and weight to match the paper loaded in the tray.</p>

Action	Yes	No
<p><b>Step 3</b></p> <p><b>a</b> Depending on your operating system, specify the paper type and weight from Printing Preferences or from the Print dialog.</p> <p><b>b</b> Resend the print job.</p> <p>Do shadow images still appear on prints?</p>	Go to step 4.	The problem is solved.
<p><b>Step 4</b></p> <p>Replace the imaging kit, and then resend the print job.</p> <p>Do shadow images still appear on prints?</p>	Contact <a href="#">customer support</a> .	The problem is solved.

### Skewed print

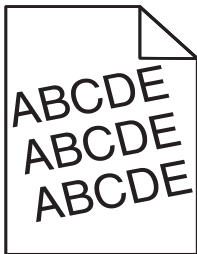

Action	Yes	No
<p><b>Step 1</b></p> <p><b>a</b> Move the width and length guides in the tray to the correct positions for the size of the paper loaded.</p> <p><b>b</b> Resend the print job.</p> <p>Is the print still skewed?</p>	Go to step 2.	The problem is solved.
<p><b>Step 2</b></p> <p><b>a</b> Check if you are printing on a paper that is supported by the tray.</p> <p><b>b</b> Resend the print job.</p> <p>Is the print still skewed?</p>	Contact <a href="#">customer support</a> .	The problem is solved.

### Streaked horizontal lines appear on prints

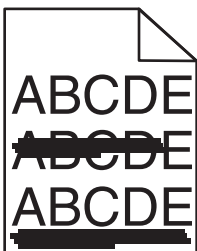



Action	Yes	No
<p><b>Step 1</b></p> <p><b>a</b> Depending on your operating system, specify the tray or feeder from Printing Preferences or the Print dialog.</p> <p><b>b</b> Resend the print job.</p> <p>Do streaked horizontal lines appear on prints?</p>	<p>Go to step 2.</p>	<p>The problem is solved.</p>
<p><b>Step 2</b></p> <p>From the printer control panel, set the paper type and weight in the Paper menu to match the paper loaded in the tray.</p> <p>Do the paper type and weight match the paper in the tray?</p>	<p>Go to step 3.</p>	<p>Do one or more of the following:</p> <ul style="list-style-type: none"> <li>• Specify the paper type and weight from the tray settings to match the paper loaded in the tray.</li> <li>• Change the paper loaded in the tray to match the paper type and weight specified in the tray settings.</li> </ul>
<p><b>Step 3</b></p> <p><b>a</b> Load paper from a fresh package.</p> <p><b>Note:</b> Paper absorbs moisture due to high humidity. Store paper in its original wrapper until you use it.</p> <p><b>b</b> Resend the print job.</p> <p>Do streaked horizontal lines appear on prints?</p>	<p>Go to step 4.</p>	<p>The problem is solved.</p>
<p><b>Step 4</b></p> <p><b>a</b> Remove, and then reinstall the imaging kit.</p> <p><b>Warning—Potential Damage:</b> Do not expose the imaging kit to direct light for more than 10 minutes. Extended exposure to light may cause print quality problems.</p> <p><b>Warning—Potential Damage:</b> Do not touch the underside of the imaging kit. This could damage the imaging kit.</p> <p><b>b</b> Resend the print job.</p> <p>Do streaked horizontal lines appear on prints?</p>	<p>Go to step 5.</p>	<p>The problem is solved.</p>
<p><b>Step 5</b></p> <p>Replace the imaging kit, and then resend the print job.</p> <p>Do streaked horizontal lines appear on prints?</p>	<p>Contact <a href="#">customer support</a>.</p>	<p>The problem is solved.</p>

### Streaked vertical lines appear on prints

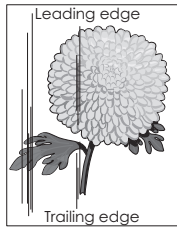
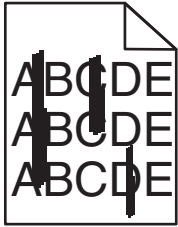

Action	Yes	No
<p><b>Step 1</b></p> <p><b>a</b> Depending on your operating system, specify the paper type, texture, and weight from Printing Preferences or from the Print dialog.</p> <p><b>b</b> Resend the print job.</p> <p>Do streaked vertical lines appear on prints?</p>	Go to step 2.	The problem is solved.
<p><b>Step 2</b></p> <p>From the printer control panel, set the paper texture, type, and weight in the Paper menu to match the paper loaded in the tray.</p> <p>Do the paper texture, type, and weight match the paper in the tray?</p>	Go to step 3.	<p>Do one or more of the following:</p> <ul style="list-style-type: none"> <li>Specify the paper texture, type, and weight from the tray settings to match the paper loaded in the tray.</li> <li>Change the paper loaded in the tray to match the paper size specified in the tray settings.</li> </ul>
<p><b>Step 3</b></p> <p><b>a</b> Load paper from a fresh package.</p> <p><b>Note:</b> Paper absorbs moisture due to high humidity. Store paper in its original wrapper until you use it.</p> <p><b>b</b> Resend the print job.</p> <p>Do streaked vertical lines appear on prints?</p>	Go to step 4.	The problem is solved.
<p><b>Step 4</b></p> <p><b>a</b> Remove, and then reinstall the imaging kit.</p> <p><b>Warning—Potential Damage:</b> Do not expose the imaging kit to direct light for more than 10 minutes. Extended exposure to light may cause print quality problems.</p> <p><b>Warning—Potential Damage:</b> Do not touch the underside of the imaging kit. This could damage the imaging kit.</p> <p><b>b</b> Resend the print job.</p> <p>Do streaked vertical lines appear on prints?</p>	Go to step 5.	The problem is solved.

Action	Yes	No
<p><b>Step 5</b>                      Replace the imaging kit, and then resend the print job.</p> <p>Do streaked vertical lines appear on prints?</p>	<p>Contact <a href="#">customer support</a>.</p>	<p>The problem is solved.</p>

**Toner fog or background shading appears on prints**

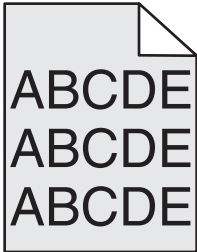

Action	Yes	No
<p><b>Step 1</b></p> <p><b>a</b> Remove, and then reinstall the imaging kit.</p> <p><b>Warning—Potential Damage:</b> Do not expose the imaging kit to direct light for more than 10 minutes. Extended exposure to light may cause print quality problems.</p> <p><b>Warning—Potential Damage:</b> Do not touch the underside of the imaging kit. This could damage the imaging kit.</p> <p><b>b</b> Resend the print job.</p> <p>Does fog or shading disappear from the prints?</p>	<p>The problem is solved.</p>	<p>Go to step 2.</p>
<p><b>Step 2</b></p> <p>Replace the imaging kit, and then resend the print job.</p> <p>Does fog or shading disappear from the prints?</p>	<p>The problem is solved.</p>	<p>Contact <a href="#">customer support</a>.</p>

**Toner rubs off**

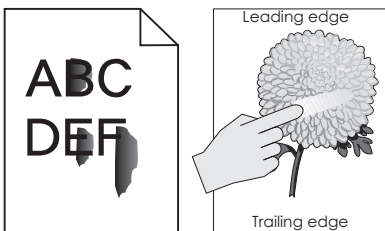

Action	Yes	No
<p><b>Step 1</b> From the Paper menu on the printer control panel, check the paper type, texture, and weight.</p> <p>Do the paper type, texture, and weight match the paper loaded in the tray?</p>	Go to step 2.	Specify the paper type, texture, and weight from the tray settings to match the paper loaded in the tray.
<p><b>Step 2</b> Resend the print job.</p> <p>Does the toner still rub off?</p>	Contact <a href="#">customer support</a> .	The problem is solved.

### Toner specks appear on prints

Action	Yes	No
<p>Replace the imaging kit, and then resend the print job.</p> <p>Do toner specks appear on prints?</p>	Contact <a href="#">customer support</a> .	The problem is solved.

### Transparency print quality is poor

Action	Yes	No
<p><b>Step 1</b> From the printer control panel, set the paper type in the Paper menu to match the paper loaded in the tray.</p> <p>Is the paper type for the tray set to Transparency?</p>	Go to step 2.	Set the paper type to Transparency.
<p><b>Step 2</b></p> <ul style="list-style-type: none"> <li>a Check if you are using a recommended type of transparency.</li> <li>b Resend the print job.</li> </ul> <p>Is the print quality still poor?</p>	Contact <a href="#">customer support</a> .	The problem is solved.

### Uneven print density

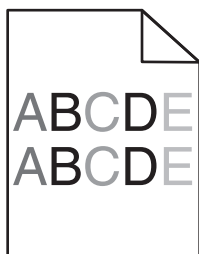

Action	Yes	No
Replace the imaging kit, and then resend the print job.  Is the print density uneven?	Contact <a href="#">customer support</a> .	The problem is solved.

### Vertical voids appear on prints

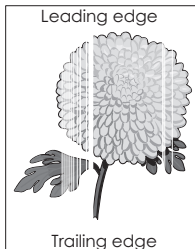

Action	Yes	No
<b>Step 1</b> a Check if your software program is using a correct fill pattern. b Resend the print job.  Do vertical voids appear on prints?	Go to step 2.	The problem is solved.
<b>Step 2</b> a From the Paper Menu on the printer control panel, check the paper type and paper weight. b Resend the print job.  Do vertical voids appear on prints?	Go to step 3.	The problem is solved.
<b>Step 3</b> Check if you are using a recommended type of paper. a Load paper source with a recommended type of paper. b Resend the print job.  Do vertical voids appear on prints?	Go to step 4.	The problem is solved.
<b>Step 4</b> a Remove, and then reinstall the imaging kit. <b>Warning—Potential Damage:</b> Do not expose the imaging kit to direct light for more than 10 minutes. Extended exposure to light may cause print quality problems. <b>Warning—Potential Damage:</b> Do not touch the underside of the imaging kit. This could damage the imaging kit. b Resend the print job.  Do vertical voids appear on prints?	Go to step 5.	The problem is solved.

Action	Yes	No
<p><b>Step 5</b>                      Replace the imaging kit, and then resend the print job.</p> <p>Do vertical voids appear on prints?</p>	<p>Contact <a href="#">customer support</a>.</p>	<p>The problem is solved.</p>

## Color quality problems

### FAQ about color printing

#### What is RGB color?

Red, green, and blue light can be added together in various amounts to produce a large range of colors observed in nature. For example, red and green can be combined to create yellow. Televisions and computer monitors create colors in this manner. RGB color is a method of describing colors by indicating the amount of red, green, or blue needed to produce a certain color.

#### What is CMYK color?

Cyan, magenta, yellow, and black inks or toners can be printed in various amounts to produce a large range of colors observed in nature. For example, cyan and yellow can be combined to create green. Printing presses, inkjet printers, and color laser printers create colors in this manner. CMYK color is a method of describing colors by indicating the amount of cyan, magenta, yellow, and black needed to reproduce a particular color.

#### How is color specified in a document to be printed?

Software programs typically specify the document color using RGB or CMYK color combinations. Additionally, they let users modify the color of each object in a document. For more information, see the help information of your operating system.

#### How does the printer know what color to print?

When a user prints a document, information describing the type and color of each object is sent to the printer. The color information is passed through color conversion tables that translate the color into the appropriate amounts of cyan, magenta, yellow, and black toner needed to produce the color you want. The object information determines the application of color conversion tables. For example, it is possible to apply one type of color conversion table to text while applying a different color conversion table to photographic images.

#### What is manual color correction?

When manual color correction is enabled, the printer employs user-selected color conversion tables to process objects. However, Color Correction must be set to Manual, or no user-defined color conversion will be implemented. Manual color correction settings are specific to the type of object being printed (text, graphics, or images), and how the color of the object is specified in the software program (RGB or CMYK combinations).

#### Notes:

- Manual color correction is not useful if the software program does not specify colors with RGB or CMYK combinations. It is also not effective in situations in which the software program or the computer operating system controls the adjustment of colors.
- When **Auto Color Correction** is selected, the color conversion tables will generate preferred colors used for the majority of the documents.

To manually apply a different color conversion table, do the following:

- 1 From the Quality menu on the printer control panel, select **Color Correction**, and then select **Manual**.
- 2 From the Quality menu on the printer control panel, select **Manual Color**, and then select the appropriate color conversion table for the affected object type.

Object type	Color conversion tables
RGB Image RGB Text RGB Graphics	<ul style="list-style-type: none"> <li>• <b>Vivid</b>—Produces brighter, more saturated colors and may be applied to all incoming color formats.</li> <li>• <b>sRGB Display</b>—Produces an output that approximates the colors displayed on a computer monitor. <b>Note:</b> Black toner usage is optimized for printing photographs.</li> <li>• <b>Display—True Black</b>—Produces an output that approximates the colors displayed on a computer monitor. This uses only black toner to create all levels of neutral gray.</li> <li>• <b>sRGB Vivid</b>—Provides an increased color saturation for the sRGB Display color correction. <b>Note:</b> Black toner usage is optimized for printing business graphics.</li> <li>• <b>Off</b>—No color correction is implemented.</li> </ul>
CMYK Image CMYK Text CMYK Graphics	<ul style="list-style-type: none"> <li>• <b>US CMYK</b>—Applies color correction to approximate the SWOP (Specifications for Web Offset Publishing) color output.</li> <li>• <b>Euro CMYK</b>—Applies color correction to approximate Euroscale color output.</li> <li>• <b>Vivid CMYK</b>—Increases the color saturation of the US CMYK color correction setting.</li> <li>• <b>Off</b>—No color correction is implemented.</li> </ul>

**How can I match a particular color (such as a corporate logo)?**

Nine types of Color Samples sets are available from the Quality menu on the printer control panel. These are also available from the Color Samples page of the Embedded Web Server. Selecting any sample set generates a multiple-page printout consisting of hundreds of colored boxes. Either a CMYK or RGB combination is located on each box, depending on the table selected. The observed color of each box is obtained by passing the CMYK or RGB combination labeled on the box through the selected color conversion table.

By examining Color Samples sets, you can identify the box whose color is the closest to the color you want. The color combination labeled on the box can then be used for modifying the color of the object in a software program. For more information, see the help information of your operating system.

**Note:** Manual color correction may be necessary to utilize the selected color conversion table for the particular object.

Selecting which Color Samples set to use for a particular color-matching problem depends on the Color Correction setting being used, the type of object being printed, and how the color of the object is specified in the software program. When Color Correction is set to Off, the color is based on the print job information, and no color conversion is implemented.

**Note:** The Color Samples pages are not useful if the software program does not specify colors with RGB or CMYK combinations. Additionally, certain situations exist in which the software program or the computer operating system adjusts the RGB or CMYK combinations specified in the program through color management. The resulting printed color may not be an exact match of the Color Samples pages.

### Prints on color transparencies appear dark when projected

**Note:** This problem occurs when projecting transparencies with reflective overhead projectors. To obtain the highest projected color quality, transmissive overhead projectors are recommended.

Action	Yes	No
<p><b>Step 1</b></p> <p>From the printer control panel, make sure the paper type setting is set to Transparency.</p> <p>Is the paper type setting correct?</p>	Go to step 2.	Set the paper type to Transparency.
<p><b>Step 2</b></p> <p>Reduce the toner darkness, and then resend the print job.</p> <p>Does the print on the color transparency look lighter?</p>	The problem is solved.	Go to step 3.
<p><b>Step 3</b></p> <p>Make sure you are using a recommended type of color transparency, and then resend the print job.</p> <p>Does the print on the color transparency look lighter?</p>	The problem is solved.	Contact <a href="#">customer support</a> .

### The color of the print does not match the color of the original file

**Note:** The color conversion tables used in Auto Color Correction mode generally approximate the colors of a standard computer monitor. However, because of technology differences that exist between printers and monitors, there are many colors that can also be affected by monitor variations and lighting conditions.

Action	Yes	No
<p><b>Step 1</b></p> <p><b>a</b> Set Color Correction to Off.</p> <p><b>Note:</b> When the printer color correction is disabled, the color is based on the print job information, and no color conversion is implemented.</p> <p><b>b</b> Resend the print job.</p> <p>Does the color of the print match the color of the file on the computer screen?</p>	The problem is solved.	Go to step 2.
<p><b>Step 2</b></p> <p>From the Quality menu on the printer control panel, do the following:</p> <p><b>a</b> Select <b>Color Correction</b>, and then select <b>Manual</b>.</p> <p><b>b</b> Select <b>Manual Color</b>, and then select the appropriate color conversion table for the affected object type.</p> <p><b>c</b> Resend the print job.</p> <p>Does the color of the print match the color of the file on the computer screen?</p>	The problem is solved.	Contact <a href="#">customer support</a> .



### The print appears tinted

Action	Yes	No
<p>Adjust the color balance.</p> <ul style="list-style-type: none"> <li><b>a</b> From the Color Balance menu on the printer control panel, increase or decrease the values for cyan, magenta, yellow, and black.</li> <li><b>b</b> Resend the print job.</li> </ul> <p>Does the print still appear tinted?</p>	The problem is solved.	Contact <a href="#">customer support</a> .

## Solving copy problems

### Copier does not respond

Action	Yes	No
<p><b>Step 1</b></p> <p>Check if an error or status message appears on the display.</p> <p>Does an error or status message appear?</p>	Clear the error or status message.	Go to step 2.
<p><b>Step 2</b></p> <p>Check if the power cord is plugged into the printer and a properly grounded electrical outlet.</p> <p>Is the power cord plugged into the printer and a properly grounded electrical outlet?</p>	Go to step 3.	Connect the power cord to the printer and a properly grounded electrical outlet.
<p><b>Step 3</b></p> <p>Turn off the printer, then wait for about 10 seconds, and then turn it back on.</p> <p>Did <b>Performing Self Test and Ready</b> appear?</p>	The problem is solved.	Contact <a href="#">customer support</a> .

### Partial document or photo copies

Action	Yes	No
<p><b>Step 1</b></p> <p>Check the placement of the document or photo.</p> <p>Make sure the document or photo is loaded facedown on the scanner glass in the upper left corner.</p> <p>Is the document or photo loaded correctly?</p>	Go to step 2.	Place the document or photo facedown on the scanner glass in the upper left corner.

Action	Yes	No
<p><b>Step 2</b></p> <p>Check if the paper size setting matches the size of the paper loaded in the tray.</p> <p>From the Paper menu on the printer control panel, check the Paper Size setting.</p> <p>Does the paper size setting match the size of the paper loaded in the tray.</p>	Go to step 3.	Change the paper size setting to match the paper loaded in the tray, or load the tray with paper that matches the paper size setting.
<p><b>Step 3</b></p> <p><b>a</b> Specify the paper size. Depending on your operating system, specify the paper size in Printing Preferences or the Print dialog.</p> <p><b>b</b> Resend the print job.</p> <p>Do copies print properly?</p>	The problem is solved.	Contact <a href="#">customer support</a> .

### Scanner unit does not close

Action	Yes	No
<p>Check if there are no obstructions between the scanner unit and the printer.</p> <p><b>a</b> Lift the scanner unit.</p> <p><b>b</b> Remove any obstruction that keeps the scanner unit open.</p> <p><b>c</b> Lower the scanner unit.</p> <p>Did the scanner unit close properly?</p>	The problem is solved.	Contact <a href="#">customer support</a> .

### Poor copy quality

Action	Yes	No
<p><b>Step 1</b></p> <p>Check if an error or status message appears on the display.</p> <p>Does an error or status message appear?</p>	Clear the error or status message.	Go to step 2.
<p><b>Step 2</b></p> <p>Check the quality of the original document.</p> <p>Is the quality of the original document satisfactory?</p>	Go to step 3.	Increase the scan resolution setting for a higher-quality output.
<p><b>Step 3</b></p> <p>If dark marks appear on prints, then clean the scanner glass and the ADF glass using a clean, lint-free cloth dampened with water.</p> <p>Is the scanner glass clean?</p>	Go to step 4.	See <a href="#">“Cleaning the scanner glass” on page 206</a> .

Action	Yes	No
<p><b>Step 4</b> Send a print job, and then check for print quality problems.</p> <ul style="list-style-type: none"> <li><b>a</b> From the General Settings menu, adjust the Eco-Mode settings.</li> <li><b>b</b> From the Copy menu, adjust the Darkness setting.</li> <li><b>c</b> If the print remains faded, then replace the toner cartridge.</li> </ul> <p>Is the print quality satisfactory?</p>	<p>Go to step 5.</p>	<p>See <a href="#">“Print quality problems” on page 277</a>.</p>
<p><b>Step 5</b> Check the placement of the document or photo. Make sure the document or photo is loaded facedown on the scanner glass in the upper left corner.</p> <p>Is the document or photo loaded correctly?</p>	<p>Go to step 6.</p>	<p>Place the document or photo facedown on the scanner glass in the upper left corner.</p>
<p><b>Step 6</b> Check the copy settings. From the Copy screen, check if the Content Type and Content Source settings are correct for the document being scanned.</p> <p>Are the Content Type and Content Source settings correct for the document being scanned?</p>	<p>Go to step 7.</p>	<p>Change the Content Type and Content Source settings to match the document being scanned.</p>
<p><b>Step 7</b> Check for patterns on prints.</p> <ul style="list-style-type: none"> <li><b>a</b> From the Copy screen, navigate to: <b>Advanced Options &gt; Advanced Imaging &gt; Sharpness</b> &gt; select a lower setting <b>Note:</b> Make sure no scaling is being selected.</li> <li><b>b</b> Resend the copy job.</li> </ul> <p>Do patterns appear on prints?</p>	<p>Go to step 8.</p>	<p>The problem is solved.</p>
<p><b>Step 8</b> Check for missing or faded text on prints.</p> <ul style="list-style-type: none"> <li><b>a</b> From the Copy screen, navigate to: <b>Advanced Options &gt; Advanced Imaging</b></li> <li><b>b</b> Adjust the settings: <ul style="list-style-type: none"> <li>• <b>Sharpness</b>—Increase the current setting.</li> <li>• <b>Contrast</b>—Increase the current setting.</li> </ul> </li> <li><b>c</b> Resend the copy job.</li> </ul> <p>Do prints have missing or faded text?</p>	<p>Go to step 9.</p>	<p>The problem is solved.</p>

Action	Yes	No
<p><b>Step 9</b></p> <p>Check for washed-out or overexposed output.</p> <p><b>a</b> From the Copy screen, navigate to:  <b>Advanced Options &gt; Advanced Imaging</b></p> <p><b>b</b> Adjust the settings of the following:</p> <ul style="list-style-type: none"> <li>• <b>Background Removal</b>—Reduce the current setting.</li> <li>• <b>Shadow Detail</b>—Reduce the current setting.</li> </ul> <p><b>c</b> Resend the copy job.</p> <p>Do pages show washed-out or overexposed prints?</p>	<p>Contact <a href="#">customer support</a>.</p>	<p>The problem is solved.</p>

## Solving fax problems

### Caller ID is not shown

Action	Yes	No
<p>Contact your telephone company to check if your telephone line is subscribed to the caller ID service.</p> <p><b>Notes:</b></p> <ul style="list-style-type: none"> <li>• If your region supports multiple caller ID patterns, then you may have to change the default setting. There are two settings available: FSK (pattern 1) and DTMF (pattern 2).</li> <li>• The availability of these settings in the Fax menu depends on whether your country or region supports multiple caller ID patterns.</li> <li>• Contact your telephone company to determine which pattern or switch setting to use.</li> </ul> <p>Does the caller ID appear?</p>	<p>The problem is solved.</p>	<p>Contact <a href="#">customer support</a>.</p>

## Cannot send or receive a fax

Action	Yes	No
<p><b>Step 1</b> Check if an error or status message appears on the display.</p> <p>Is there an error or status message on the display?</p>	Clear the error or status message.	Go to step 2.
<p><b>Step 2</b> Check if the power cord is plugged into the printer and a properly grounded electrical outlet.</p> <p>Is the power cord plugged into the printer and a properly grounded electrical outlet?</p>	Go to step 3.	Connect the power cord to the printer and a properly grounded electrical outlet.
<p><b>Step 3</b> Check the power. Check if the printer is plugged in and turned on, and if <b>Ready</b> appears on the display.</p> <p>Is the printer turned on, and does <b>Ready</b> appear on the display?</p>	Go to step 4.	Turn on the printer, and then wait until <b>Ready</b> appears on the display.
<p><b>Step 4</b> Check the printer connections. If applicable, check if the cable connections for the following equipment are secure:</p> <ul style="list-style-type: none"> <li>• Telephone</li> <li>• Handset</li> <li>• Answering machine</li> </ul> <p>Are the cable connections secure?</p>	Go to step 5.	Securely connect the cables.
<p><b>Step 5</b></p> <p><b>a</b> Check the telephone wall jack.</p> <ol style="list-style-type: none"> <li><b>1</b> Plug the telephone cable into the wall jack.</li> <li><b>2</b> Listen for a dial tone.</li> <li><b>3</b> If you do not hear a dial tone, then plug a different telephone cable into the wall jack.</li> <li><b>4</b> If you still do not hear a dial tone, then plug the telephone cable into a different wall jack.</li> <li><b>5</b> If you hear a dial tone, then connect the printer to that wall jack.</li> </ol> <p><b>b</b> Try sending or receiving a fax.</p> <p>Can you send or receive a fax?</p>	The problem is solved.	Go to step 6.

Action	Yes	No
<p><b>Step 6</b>                      Check if the printer is connected to an analog phone service or the correct digital connector.</p> <p>The fax modem is an analog device. Certain devices can be connected to the printer so that digital telephone services can be used.</p> <ul style="list-style-type: none"> <li>• If you are using an ISDN telephone service, then connect the printer to an analog telephone port (an R-interface port) on an ISDN terminal adapter. For more information and to request an R-interface port, contact your ISDN provider.</li> <li>• If you are using DSL, then connect to a DSL filter or router that will support analog use. For more information, contact your DSL provider.</li> <li>• If you are using a PBX telephone service, then make sure you are connecting to an analog connection on the PBX. If none exists, then consider installing an analog telephone line for the fax machine.</li> </ul> <p>Is the printer connected to an analog phone service or the correct digital connector?</p>	<p>Go to step 7.</p>	<p>Connect the printer to an analog phone service or the correct digital connector.</p>
<p><b>Step 7</b>                      Check for a dial tone.</p> <p>Did you hear a dial tone?</p>	<p>Go to step 8.</p>	<ul style="list-style-type: none"> <li>• Try calling the fax number to make sure that it is working properly.</li> <li>• If the telephone line is being used by another device, then wait until the other device is finished before sending a fax.</li> <li>• If you are using the On Hook Dial feature, then turn up the volume to check if you hear a dial tone.</li> </ul>
<p><b>Step 8</b>                      Temporarily disconnect other equipment (such as answering machines, computers with modems, or telephone line splitters) between the printer and the telephone line, and then try sending or receiving a fax.</p> <p>Can you send or receive a fax?</p>	<p>The problem is solved.</p>	<p>Go to step 9.</p>
<p><b>Step 9</b></p> <p><b>a</b> Temporarily disable call waiting. Contact your telephone company to obtain the keypad sequence for temporarily disabling call waiting.</p> <p><b>b</b> Try sending or receiving a fax.</p> <p>Can you send or receive a fax?</p>	<p>The problem is solved.</p>	<p>Go to step 10.</p>

Action	Yes	No
<p><b>Step 10</b></p> <p><b>a</b> Temporarily disable voice mail service. For more information, contact your telephone company.</p> <p><b>Note:</b> If you want to use both voice mail and the printer, then consider adding a second telephone line for the printer.</p> <p><b>b</b> Try sending or receiving a fax.</p> <p>Can you send or receive a fax?</p>	The problem is solved.	Go to step 11.
<p><b>Step 11</b></p> <p>Scan the original document one page at a time.</p> <p><b>a</b> Dial the fax number.</p> <p><b>b</b> Scan the document one page at a time.</p> <p>Can you send or receive a fax?</p>	The problem is solved.	Contact <a href="#">customer support</a> .

### Can send but not receive faxes

Action	Yes	No
<p><b>Step 1</b></p> <p>Check the tray or feeder.</p> <p>If empty, then load paper in the tray or feeder.</p> <p>Can you receive faxes?</p>	The problem is solved.	Go to step 2.
<p><b>Step 2</b></p> <p>Check the ring count delay settings.</p> <p><b>a</b> Open a Web browser, and then type the printer IP address in the address field.</p> <p><b>Notes:</b></p> <ul style="list-style-type: none"> <li>View the printer IP address on the printer home screen. The IP address appears as four sets of numbers separated by periods, such as 123.123.123.123.</li> <li>If you are using a proxy server, then temporarily disable it to load the Web page correctly.</li> </ul> <p><b>b</b> Click <b>Settings &gt; Fax Settings &gt; Analog Fax Setup</b>.</p> <p><b>c</b> In the “Rings to Answer” field, enter the number of times you want the phone to ring before the printer answers.</p> <p><b>d</b> Click <b>Submit</b>.</p> <p>Can you receive faxes?</p>	The problem is solved.	Go to step 3.

Action	Yes	No
<p><b>Step 3</b>                      Replace the toner cartridge. For more information, see the instruction sheet that came with the supply.</p> <p>Can you receive faxes?</p>	The problem is solved.	Contact <a href="#">customer support</a> .

### Can receive but not send faxes



Action	Yes	No
<p><b>Step 1</b>                      Check if the printer is in Fax mode.                      From the home screen, touch <b>Fax</b> to put the printer in Fax mode, and then send the fax.</p> <p><b>Note:</b> The Multi Send application does not support the XPS output type. To use XPS, use the regular faxing method.</p> <p>Can you send faxes?</p>	The problem is solved.	Go to step 2.
<p><b>Step 2</b>                      Load the original document properly.                      Load the original document faceup, short edge first into the ADF tray or facedown on the scanner glass in the upper left corner.</p> <p><b>Note:</b> Do not load postcards, photos, small items, transparencies, photo paper, or thin media (such as magazine clippings) into the ADF tray. Place these items on the scanner glass.</p> <p>Can you send faxes?</p>	The problem is solved.	Go to step 3.
<p><b>Step 3</b>                      Set up the shortcut number properly.</p> <ul style="list-style-type: none"> <li>• Check if the shortcut number has been set for the telephone number that you want to dial.</li> <li>• Dial the telephone number manually.</li> </ul> <p>Can you send faxes?</p>	The problem is solved.	Contact <a href="#">customer support</a> .

### Fax and e-mail functions are not set up

**Notes:**

- Before you troubleshoot, check if the fax cables are connected.
- The indicator light is blinking red until you set up fax and e-mail.



Action	Yes	No
<p><b>a</b> From the home screen, navigate to:</p> <p> &gt; <b>Settings</b> &gt; <b>General Settings</b> &gt; <b>Run initial setup</b> &gt; <b>Yes</b> &gt; <b>Submit</b></p> <p><b>b</b> Turn off the printer, and then turn it back on. The “Select your language” screen appears on the printer display.</p> <p><b>c</b> Select a language, and then touch .</p> <p><b>d</b> Select a country or region, and then touch <b>Next</b>.</p> <p><b>e</b> Select a time zone, and then touch <b>Next</b>.</p> <p><b>f</b> Select <b>Fax</b> and <b>E-mail</b>, and then touch <b>Next</b>.</p> <p>Are fax and e-mail functions set up?</p>	<p>The problem is solved.</p>	<p>Contact <a href="#">customer support</a>.</p>

### Received fax has poor print quality

Action	Yes	No
<p><b>Step 1</b></p> <p>Ask the person who sent you the fax to:</p> <p><b>a</b> Check if the quality of the original document is satisfactory.</p> <p><b>b</b> Increase the fax scan resolution, if possible.</p> <p><b>c</b> Resend the fax.</p> <p>Is the fax print quality satisfactory?</p>	<p>The problem is solved.</p>	<p>Go to step 2.</p>

Action	Yes	No
<p><b>Step 2</b> Decrease the incoming fax transmission speed.</p> <p><b>a</b> Open a Web browser, and then type the printer IP address in the address field.</p> <p><b>Notes:</b></p> <ul style="list-style-type: none"> <li>• View the printer IP address on the printer home screen. The IP address appears as four sets of numbers separated by periods, such as 123.123.123.123.</li> <li>• If you are using a proxy server, then temporarily disable it to load the Web page correctly.</li> <li>• Print a network setup page or menu settings page, and then locate the IP address in the TCP/IP section.</li> </ul> <p><b>b</b> Click <b>Settings &gt; Fax Settings &gt; Analog Fax Setup</b>.</p> <p><b>c</b> In the Max Speed menu, click one of the following:</p> <ul style="list-style-type: none"> <li>• 2400</li> <li>• 4800</li> <li>• 9600</li> <li>• 14400</li> <li>• 33600</li> </ul> <p><b>d</b> Click <b>Submit</b>, and then resend the fax.</p> <p>Is the fax print quality satisfactory?</p>	<p>The problem is solved.</p>	<p>Go to step 3.</p>
<p><b>Step 3</b> Replace the toner cartridge.</p> <p>When <b>Cartridge low [88.xy]</b> appears, replace the cartridge, and then resend the fax.</p> <p>Is the fax print quality satisfactory?</p>	<p>The problem is solved.</p>	<p>Contact <a href="#">customer support</a>.</p>

## Solving scanner problems

### Cannot scan from a computer

Action	Yes	No
<p><b>Step 1</b> Make sure the printer is turned on and that <b>Ready</b> appears on the printer display before scanning a job.</p> <p>Does <b>Ready</b> appear before scanning the job?</p>	Go to step 3.	Go to step 2.
<p><b>Step 2</b> Turn off the printer, then wait for about 10 seconds, and then turn the printer back on.</p> <p>Is there an error message on the printer display?</p>	Clear the error message.	Go to step 3.
<p><b>Step 3</b> Check the cable connections between the printer and the print server to make sure they are secure. For more information, see the setup documentation that came with the printer.</p> <p>Are the cable connections between the printer and the print server secure?</p>	Contact <a href="#">customer support</a> .	Tighten the cable connections.

### Scan job was not successful

Action	Yes	No
<p><b>Step 1</b> Check the cable connections. Make sure the Ethernet or USB cable is securely connected to the computer and the printer.</p> <p>Are the cables securely connected?</p>	Go to step 2.	Connect the cables properly.
<p><b>Step 2</b> Check if the file name is already in use.</p> <p>Is the file name already in use?</p>	Change the file name.	Go to step 3.
<p><b>Step 3</b> Check if the document or photo you want to scan is open in another application or being used by another user.</p> <p>Is the file you want to scan open by another application or user?</p>	Close the file you are scanning.	Go to step 4.

Action	Yes	No
<p><b>Step 4</b> Check if either the <b>Append time stamp</b> or the <b>Overwrite existing file</b> check box is selected in the destination configuration settings.</p> <p>Is the <b>Append time stamp</b> or <b>Overwrite existing file</b> check box selected in the destination configuration settings?</p>	Contact <a href="#">customer support</a> .	Select the <b>Append time stamp</b> or <b>Overwrite existing file</b> check box in the destination configuration settings.

### Scanner unit does not close

Action	Yes	No
<p>Check if there are obstructions in the scanner unit.</p> <ul style="list-style-type: none"> <li>a Lift the scanner unit.</li> <li>b Remove any obstruction keeping the scanner unit open.</li> <li>c Lower the scanner unit.</li> </ul> <p>Did the scanner unit close correctly?</p>	The problem is solved.	Contact <a href="#">customer support</a> .

### Scanning takes too long or freezes the computer

Action	Yes	No
<p><b>Step 1</b> Check if other applications are interfering with the scan. Close all applications that are not being used.</p> <p>Does scanning still take too long or freeze the computer?</p>	Go to step 2.	The problem is solved.
<p><b>Step 2</b> Select a lower scan resolution.</p> <p>Does scanning still take too long or freeze the computer?</p>	Contact <a href="#">customer support</a> .	The problem is solved.

### Poor scanned image quality

Action	Yes	No
<p><b>Step 1</b> Check if an error message appears on the display.</p> <p>Is there an error message on the printer display?</p>	Clear the error message.	Go to step 2.
<p><b>Step 2</b> Check the quality of the original document.</p> <p>Is the quality of the original document satisfactory?</p>	Go to step 3.	Increase the scan resolution settings for a higher-quality output.

Action	Yes	No
<p><b>Step 3</b></p> <p>Clean the scanner glass and the ADF glass using a clean, lint-free cloth dampened with water.</p> <p>Is the scanner glass clean?</p>	Go to step 4.	See <a href="#">“Cleaning the scanner glass” on page 206.</a>
<p><b>Step 4</b></p> <p>Check the placement of the document or photo.</p> <p>Make sure the document or photo is loaded facedown on the scanner glass in the upper left corner.</p> <p>Is the document or photo loaded correctly?</p>	Go to step 5.	Place the document or photo facedown on the scanner glass in the upper left corner.
<p><b>Step 5</b></p> <p>Send a print job, and then check for print quality problems.</p> <ul style="list-style-type: none"> <li>• From the General Settings menu, adjust the Eco-Mode settings.</li> <li>• From the Copy menu, adjust the Darkness setting.</li> <li>• When the print becomes faded, replace the toner cartridge.</li> </ul> <p>Is the print quality satisfactory?</p>	Go to step 6.	See <a href="#">“Print quality problems” on page 277.</a>
<p><b>Step 6</b></p> <p>Check the scan settings.</p> <p>From the Scan screen, make sure the Content Type and Content Source settings are correct for the document being scanned.</p> <p>Are the Content Type and Content Source settings correct for the document being scanned?</p>	Go to step 7.	Change the Content Type and Content Source settings to match the document being scanned.
<p><b>Step 7</b></p> <p>Increase the scan resolution settings for a higher-quality output.</p> <p>Did the increased resolution produce a higher-quality output?</p>	Problem solved.	Contact <a href="#">customer support.</a>

### Partial document or photo scans

Action	Yes	No
<p>Check the placement of the document or photo.</p> <p>Make sure the document or photo is loaded facedown on the scanner glass in the upper left corner.</p> <p>Is the document or photo loaded correctly?</p>	Contact <a href="#">customer support.</a>	Load the document or photo facedown on the scanner glass in the upper left corner.

## The scanner does not respond

Action	Yes	No
<p><b>Step 1</b> Check if the printer is turned on.</p> <p>Is the printer turned on?</p>	Go to step 2.	Turn on the printer.
<p><b>Step 2</b> Check if the printer cable is securely attached to the printer and the computer, print server, option, or other network device.</p> <p>Is the printer cable securely attached to the printer and the computer, print server, option, or other network device?</p>	Go to step 3.	Connect the printer cable securely to the printer and the computer, print server, option, or other network device.
<p><b>Step 3</b> Check if the power cord is plugged into the printer and a properly grounded electrical outlet.</p> <p>Is the power cord plugged into the printer and a properly grounded electrical outlet?</p>	Go to step 4.	Connect the power cord to the printer and a properly grounded electrical outlet.
<p><b>Step 4</b> Check if the electrical outlet is turned off by a switch or breaker.</p> <p>Is the electrical outlet turned off by a switch or breaker?</p>	Turn on the switch or reset the breaker.	Go to step 5.
<p><b>Step 5</b> Check if the printer is plugged into any surge protectors, uninterruptible power supplies, or extension cords.</p> <p>Is the printer plugged into any surge protectors, uninterruptible power supplies, or extension cords?</p>	Connect the printer power cord directly to a properly grounded electrical outlet.	Go to step 6.
<p><b>Step 6</b> Check other electrical equipment plugged into the outlet.</p> <p>Are the other electrical equipment working?</p>	Unplug the other electrical equipment and turn on the printer. If the printer does not work, then reconnect the other electrical equipment and then go to step 6.	Go to step 7.
<p><b>Step 7</b> Turn off the printer, then wait for about 10 seconds, and then turn the printer back on.</p> <p>Are the printer and scanner working?</p>	The problem is solved.	Contact <a href="#">customer support</a> .

## Solving home screen application problems

### An application error has occurred

Action	Yes	No
<p><b>Step 1</b> Check the system log for relevant details.</p> <p><b>a</b> Open a Web browser, and then type the printer IP address in the address field.</p> <p>If you do not know the IP address of the printer, then you can:</p> <ul style="list-style-type: none"> <li>• View the IP address on the printer home screen.</li> <li>• Print a network setup page or the menu settings pages, and then locate the IP address in the TCP/IP section.</li> </ul> <p><b>Note:</b> An IP address appears as four sets of numbers separated by periods, such as 123.123.123.123.</p> <p><b>b</b> Click <b>Settings &gt; Apps &gt; Apps Management &gt; System tab &gt; Log</b>.</p> <p><b>c</b> From the Filter menu, select an application status.</p> <p><b>d</b> From the Application menu, select an application, and then click <b>Submit</b>.</p> <p>Does an error message appear in the log?</p>	Go to step 2.	Contact <a href="#">customer support</a> .
<p><b>Step 2</b> Resolve the error.</p> <p>Is the application working now?</p>	The problem is solved.	Contact <a href="#">customer support</a> .

### Embedded Web Server does not open

Action	Yes	No
<p><b>Step 1</b></p> <p><b>a</b> Turn on the printer.</p> <p><b>b</b> Open a Web browser, and then type the printer IP address.</p> <p><b>c</b> Press <b>Enter</b>.</p> <p>Does the Embedded Web Server open?</p>	The problem is solved.	Go to step 2.

Action	Yes	No
<p><b>Step 2</b>                      Make sure the printer IP address is correct.</p> <p><b>a</b> View the printer IP address:</p> <ul style="list-style-type: none"> <li>• From the TCP/IP section in the Network/Ports menu</li> <li>• By printing a network setup page or menu settings page, and then finding the TCP/IP section</li> </ul> <p><b>Note:</b> An IP address appears as four sets of numbers separated by periods, such as 123.123.123.123.</p> <p><b>b</b> Open a Web browser, and then type the IP address.</p> <p><b>Note:</b> Depending on the network settings, you may need to type “https://” instead of “http://” before the printer IP address to access the Embedded Web Server.</p> <p><b>c</b> Press <b>Enter</b>.</p> <p>Does the Embedded Web Server open?</p>	<p>The problem is solved.</p>	<p>Go to step 3.</p>
<p><b>Step 3</b>                      Check if the network is working.</p> <p><b>a</b> Print a network setup page.</p> <p><b>b</b> Check the first section of the network setup page and confirm that the status is Connected.</p> <p><b>Note:</b> If the status is Not Connected, then the connection may be intermittent, or the network cable may be defective. Contact your system support person for a solution, and then print another network setup page.</p> <p><b>c</b> Open a Web browser, and then type the printer IP address.</p> <p><b>d</b> Press <b>Enter</b>.</p> <p>Does the Embedded Web Server open?</p>	<p>The problem is solved.</p>	<p>Go to step 4.</p>
<p><b>Step 4</b>                      Check if the cable connections to the printer and print server are secure.</p> <p><b>a</b> Connect the cables properly. For more information, see the setup documentation that came with the printer.</p> <p><b>b</b> Open a Web browser, and then type the printer IP address.</p> <p><b>c</b> Press <b>Enter</b>.</p> <p>Does the Embedded Web Server open?</p>	<p>The problem is solved.</p>	<p>Go to step 5.</p>
<p><b>Step 5</b>                      Temporarily disable the Web proxy servers.                      Proxy servers may block or restrict you from accessing certain Web sites including the Embedded Web Server.</p> <p>Does the Embedded Web Server open?</p>	<p>The problem is solved.</p>	<p>Contact your system support person.</p>



## Contacting customer support

When you contact customer support, you will need to be able to describe the problem you are experiencing, the message on the printer display, and the troubleshooting steps you have already taken to find a solution.

You need to know your printer model type and serial number. For more information, see the label at the back of the printer. The serial number is also listed on the menu settings page.

Lexmark has various ways to help you solve your printing problem. Visit the Lexmark Web site at <http://support.lexmark.com>, and then select one of the following:

<b>Tech Library</b>	You can browse our library of manuals, support documentation, drivers, and other downloads to help you solve common problems.
<b>E-mail</b>	You can send an e-mail to the Lexmark team, describing your problem. A service representative will respond and provide you with information to solve your problem.
<b>Live chat</b>	You can chat directly with a service representative. They can work with you to solve your printer problem or provide assistance through Assisted Service where the service representative can remotely connect to your computer through the Internet to troubleshoot problems, install updates, or complete other tasks to help you successfully use your Lexmark product.

Telephone support is also available. In the U.S. or Canada, call 1-800-539-6275. For other countries or regions, visit <http://support.lexmark.com>.

# Notices

## Product information

Product name:

Lexmark CX510de and CX510dthe

Machine type:

7527

Model(s):

636, 637

## Edition notice

September 2014

**The following paragraph does not apply to any country where such provisions are inconsistent with local law:**

LEXMARK INTERNATIONAL, INC., PROVIDES THIS PUBLICATION "AS IS" WITHOUT WARRANTY OF ANY KIND, EITHER EXPRESS OR IMPLIED, INCLUDING, BUT NOT LIMITED TO, THE IMPLIED WARRANTIES OF MERCHANTABILITY OR FITNESS FOR A PARTICULAR PURPOSE. Some states do not allow disclaimer of express or implied warranties in certain transactions; therefore, this statement may not apply to you.

This publication could include technical inaccuracies or typographical errors. Changes are periodically made to the information herein; these changes will be incorporated in later editions. Improvements or changes in the products or the programs described may be made at any time.

References in this publication to products, programs, or services do not imply that the manufacturer intends to make these available in all countries in which it operates. Any reference to a product, program, or service is not intended to state or imply that only that product, program, or service may be used. Any functionally equivalent product, program, or service that does not infringe any existing intellectual property right may be used instead. Evaluation and verification of operation in conjunction with other products, programs, or services, except those expressly designated by the manufacturer, are the user's responsibility.

For Lexmark technical support, visit <http://support.lexmark.com>.

For information on supplies and downloads, visit [www.lexmark.com](http://www.lexmark.com).

© 2014 Lexmark International, Inc.

All rights reserved.

## GOVERNMENT END USERS

The Software Program and any related documentation are "Commercial Items," as that term is defined in 48 C.F.R. 2.101, "Computer Software" and "Commercial Computer Software Documentation," as such terms are used in 48 C.F.R. 12.212 or 48 C.F.R. 227.7202, as applicable. Consistent with 48 C.F.R. 12.212 or 48 C.F.R. 227.7202-1 through 227.7202-4, as applicable, the Commercial Computer Software and Commercial Software Documentation are licensed to the U.S. Government end users (a) only as Commercial Items and (b) with only those rights as are granted to all other end users pursuant to the terms and conditions herein.

## Licensing notices

All licensing notices associated with this product can be viewed from the root directory of the installation software CD.

## Trademarks

Lexmark, Lexmark with diamond design, MarkNet, and MarkVision are trademarks of Lexmark International, Inc., registered in the United States and/or other countries.

Mac and the Mac logo are trademarks of Apple Inc., registered in the U.S. and other countries.

PCL® is a registered trademark of the Hewlett-Packard Company. PCL is Hewlett-Packard Company’s designation of a set of printer commands (language) and functions included in its printer products. This printer is intended to be compatible with the PCL language. This means the printer recognizes PCL commands used in various application programs, and that the printer emulates the functions corresponding to the commands.

The following terms are trademarks or registered trademarks of these companies:

Albertus	The Monotype Corporation plc
Antique Olive	Monsieur Marcel OLIVE
Apple-Chancery	Apple Computer, Inc.
Arial	The Monotype Corporation plc
CG Times	Based on Times New Roman under license from The Monotype Corporation plc, is a product of Agfa Corporation
Chicago	Apple Computer, Inc.
Clarendon	Linotype-Hell AG and/or its subsidiaries
Eurostile	Nebiolo
Geneva	Apple Computer, Inc.
GillSans	The Monotype Corporation plc
Helvetica	Linotype-Hell AG and/or its subsidiaries
Hoefler	Jonathan Hoefler Type Foundry
ITC Avant Garde Gothic	International Typeface Corporation
ITC Bookman	International Typeface Corporation
ITC Mona Lisa	International Typeface Corporation
ITC Zapf Chancery	International Typeface Corporation
Joanna	The Monotype Corporation plc
Marigold	Arthur Baker
Monaco	Apple Computer, Inc.
New York	Apple Computer, Inc.
Oxford	Arthur Baker
Palatino	Linotype-Hell AG and/or its subsidiaries
Stempel Garamond	Linotype-Hell AG and/or its subsidiaries

Taffy	Agfa Corporation
Times New Roman	The Monotype Corporation plc
Univers	Linotype-Hell AG and/or its subsidiaries

All other trademarks are the property of their respective owners.

AirPrint and the AirPrint logo are trademarks of Apple, Inc.

### Noise emission levels

The following measurements were made in accordance with ISO 7779 and reported in conformance with ISO 9296.

**Note:** Some modes may not apply to your product.

1-meter average sound pressure, dBA	
Printing	52
Scanning	49
Copying	50
Ready	16

Values are subject to change. See [www.lexmark.com](http://www.lexmark.com) for current values.

### Waste from Electrical and Electronic Equipment (WEEE) directive



The WEEE logo signifies specific recycling programs and procedures for electronic products in countries of the European Union. We encourage the recycling of our products.

If you have further questions about recycling options, visit the Lexmark Web site at [www.lexmark.com](http://www.lexmark.com) for your local sales office phone number.

### India E-Waste notice

This product complies with the India E-Waste (Management and Handling) Rules, 2011, which prohibit use of lead, mercury, hexavalent chromium, polybrominated biphenyls, or polybrominated diphenyl ethers in concentrations exceeding 0.1% by weight and 0.01% by weight for cadmium, except for the exemption set in Schedule II of the Rules.

## Product disposal

Do not dispose of the printer or supplies in the same manner as normal household waste. Consult your local authorities for disposal and recycling options.

## Static sensitivity notice



This symbol identifies static-sensitive parts. Do not touch in the areas near these symbols without first touching the metal frame of the printer.

## ENERGY STAR

Any Lexmark product bearing the ENERGY STAR emblem on the product or on a start-up screen is certified to comply with Environmental Protection Agency (EPA) ENERGY STAR requirements as configured when shipped by Lexmark.



## Temperature information

Ambient operating temperature	15.6 to 32.2°C (60 to 90°F)
Shipping temperature	-40 to 43.3°C (-40 to 110°F)
Storage temperature and relative humidity	1 to 35°C (34 to 95°F) 8 to 80% RH

## Laser notice

The printer is certified in the U.S. to conform to the requirements of DHHS 21 CFR, Chapter I, Subchapter J for Class I (1) laser products, and elsewhere is certified as a Class I laser product conforming to the requirements of IEC 60825-1.

Class I laser products are not considered to be hazardous. The printer contains internally a Class IIIb (3b) laser that is nominally a 7 milliwatt gallium arsenide laser operating in the wavelength of 655–675 nanometers. The laser system and printer are designed so there is never any human access to laser radiation above a Class I level during normal operation, user maintenance, or prescribed service condition.

## Laser advisory label

A laser notice label may be affixed to this printer as shown:

DANGER - Invisible laser radiation when cartridges are removed and interlock defeated. Avoid exposure to laser beam.  
 PERIGO - Radiação a laser invisível será liberada se os cartuchos forem removidos e o lacre rompido. Evite a exposição aos feixes de laser.  
 Opasnost - Nevidljivo lasersko zračenje kada su kasete uklonjene i poništena sigurnosna veza. Izbjegavati izlaganje zracima.  
 NEBEZPEČÍ - Když jsou vyjmuty kazety a je odblokována pojistka, ze zařízení je vysíláno neviditelné laserové záření. Nevystavujte se působení laserového paprsku.  
 FARE - Usynlig laserstråling, når patroner fjernes, og spærreanordningen er slået fra. Undgå at blive udsat for laserstrålen.  
 GEVAAR - Onzichtbare laserstraling wanneer cartridges worden verwijderd en een vergrendeling wordt genegeerd. Voorkom blootstelling aan de laser.  
 DANGER - Rayonnements laser invisibles lors du retrait des cartouches et du déverrouillage des loquets. Eviter toute exposition au rayon laser.  
 VAARA - Näkymätöntä lasersäteilyä on varottava, kun värikasetit on poistettu ja lukitus on auki. Vältä lasersäteelle altistumista.  
 GEFAHR - Unsichtbare Laserstrahlung beim Herausnehmen von Druckkassetten und offener Sicherheitssperre. Laserstrahl meiden.  
 ΚΙΝΔΥΝΟΣ - Εκκυσή αόρατης ακτινοβολίας laser κατά την αφαίρεση των κασετών και την απασφάλιση της μανδάλωσης. Αποφεύγετε την έκθεση στην ακτινοβολία laser.  
 VESZÉLY - Nem látható lézersugárzás fordulhat elő a patronok eltávolításakor és a zárószervezet felbontásakor. Kerülje a lézersugárnak való kitettséget.  
 PERICOLO - Emissione di radiazioni laser invisibili durante la rimozione delle cartucce e del blocco. Evitare l'esposizione al raggio laser.  
 FARE – Usynlig laserstråling når kassetene tas ut og sperrer er satt ut av spill. Unngå eksponering for laserstrålen.  
 NIEBEZPIECZYSTWO - niewidzialne promieniowanie laserowe podczas usuwania kaset i blokady. Należy unikać naświetlenia promieniem lasera.  
 ОПАСНО! Невидимое лазерное излучение при извлеченных картриджах и снятии блокировки. Избегайте воздействия лазерных лучей.  
 Pozor – Nebezpečnostvo neviditeľného laserového žiarenia pri odobratých kazetách a odblokovanej pojistke. Nevystavujte sa lúčom.  
 PELIGRO: Se producen radiaciones láser invisibles al extraer los cartuchos con el interbloqueo desactivado. Evite la exposición al haz de láser.  
 FARA – Osynlig laserstrålning när patroner tas ur och spärrmekanismen är upphävd. Undvik exponering för laserstrålen.  
 危険 - 当移除碳粉盒及互锁失效时会产生看不见的激光辐射, 请避免暴露在激光光束下。  
 危険 - 移除碳粉匣與安全連續開關失效時會產生看不見的雷射輻射。請避免曝露在雷射光束下。  
 危険 - カートリッジが取り外され、内部ロックが無効になると、見えないレーザー光が放射されます。このレーザー光に当たらないようにしてください。

## Power consumption

### Product power consumption

The following table documents the power consumption characteristics of the product.

**Note:** Some modes may not apply to your product.

Mode	Description	Power consumption (Watts)
Printing	The product is generating hard-copy output from electronic inputs.	600
Copy	The product is generating hard-copy output from hard-copy original documents.	640
Scan	The product is scanning hard-copy documents.	65
Ready	The product is waiting for a print job.	35
Sleep Mode	The product is in a high-level energy-saving mode.	3.7
Hibernate	The product is in a low-level energy-saving mode.	0.5
Off	The product is plugged into an electrical outlet, but the power switch is turned off.	0

The power consumption levels listed in the previous table represent time-averaged measurements. Instantaneous power draws may be substantially higher than the average.

Values are subject to change. See [www.lexmark.com](http://www.lexmark.com) for current values.

## Sleep Mode

This product is designed with an energy-saving mode called *Sleep Mode*. The Sleep Mode saves energy by lowering power consumption during extended periods of inactivity. The Sleep Mode is automatically engaged after this product is not used for a specified period of time, called the *Sleep Mode Timeout*.

Factory default Sleep Mode Timeout for this product (in minutes):	20
---	----

By using the configuration menus, the Sleep Mode Timeout can be modified between 1 minute and 120 minutes. Setting the Sleep Mode Timeout to a low value reduces energy consumption, but may increase the response time of the product. Setting the Sleep Mode Timeout to a high value maintains a fast response, but uses more energy.

## Hibernate Mode

This product is designed with an ultra-low power operating mode called *Hibernate mode*. When operating in Hibernate Mode, all other systems and devices are powered down safely.

The Hibernate mode can be entered in any of the following methods:

- Using the Hibernate Timeout
- Using the Schedule Power modes
- Using the Sleep/Hibernate button

Factory default Hibernate Timeout for this product in all countries or regions	3 days
--	--------

The amount of time the printer waits after a job is printed before it enters Hibernate mode can be modified between one hour and one month.

## Off mode

If this product has an off mode which still consumes a small amount of power, then to completely stop product power consumption, disconnect the power supply cord from the electrical outlet.

## Total energy usage

It is sometimes helpful to calculate the total product energy usage. Since power consumption claims are provided in power units of Watts, the power consumption should be multiplied by the time the product spends in each mode in order to calculate energy usage. The total product energy usage is the sum of each mode's energy usage.

## Regulatory notices for electromagnetic compatibility

This section contains regulatory information pertaining to electromagnetic compatibility.

## Federal Communications Commission (FCC) compliance information statement

This product has been tested and found to comply with the limits for a Class B digital device, pursuant to Part 15 of the FCC Rules. Operation is subject to the following two conditions: (1) this device may not cause harmful interference, and (2) this device must accept any interference received, including interference that may cause undesired operation.

The FCC Class B limits are designed to provide reasonable protection against harmful interference when the equipment is operated in a residential installation. This equipment generates, uses, and can radiate radio frequency energy and, if not installed and used in accordance with the instructions, may cause harmful interference to radio communications. However, there is no guarantee that interference will not occur in a particular installation. If this equipment does cause harmful interference to radio or television reception, which can be determined by turning the equipment off and on, the user is encouraged to try to correct the interference by one or more of the following measures:

- Reorient or relocate the receiving antenna.
- Increase the separation between the equipment and receiver.
- Connect the equipment into an outlet on a circuit different from that to which the receiver is connected.
- Consult your point of purchase or service representative for additional suggestions.

The manufacturer is not responsible for radio or television interference caused by using other than recommended cables or by unauthorized changes or modifications to this equipment. Unauthorized changes or modifications could void the user's authority to operate this equipment.

**Note:** To assure compliance with FCC regulations on electromagnetic interference for a Class B computing device, use a properly shielded and grounded cable such as Lexmark part number 1021231 for parallel attach or 1021294 for USB attach. Use of a substitute cable not properly shielded and grounded may result in a violation of FCC regulations.

Any questions regarding this compliance information statement should be directed to:

Director of Lexmark Technology & Services  
Lexmark International, Inc.  
740 West New Circle Road  
Lexington, KY 40550  
(859) 232-3000

## Industry Canada compliance statement

This Class B digital apparatus meets all requirements of the Canadian Interference-Causing Equipment Standard ICES-003.

## Avis de conformité aux normes de l'industrie du Canada

Cet appareil numérique de classe B est conforme aux exigences de la norme canadienne relative aux équipements pouvant causer des interférences NMB-003.

## 日本の VCCI 規定

製品にこのマークが表示されている場合、次の要件を満たしています。



この装置は、クラス B 情報技術装置です。この装置は、家庭環境で使用することを目的としていますが、この装置がラジオやテレビジョン受信機に近接して使用されると、受信障害を引き起こすことがあります。

取扱説明書に従って正しい取り扱いをしてください。

VCCI-B



## European Community (EC) directives conformity

This product is in conformity with the protection requirements of EC Council directives 2004/108/EC, 2006/95/EC, 2009/125/EC, and 2011/65/EU on the approximation and harmonization of the laws of the Member States relating to electromagnetic compatibility, safety of electrical equipment designed for use within certain voltage limits, the ecodesign of energy-related products, and on the restrictions of use of certain hazardous substances in electrical and electronic equipment.

The manufacturer of this product is: Lexmark International, Inc., 740 West New Circle Road, Lexington, KY, 40550 USA. The authorized representative is: Lexmark International Technology Hungária Kft., 8 Lechner Ödön fasor, Millennium Tower III, 1095 Budapest HUNGARY. A declaration of conformity to the requirements of the Directives is available upon request from the Authorized Representative.

This product satisfies the Class B limits of EN 55022 and safety requirements of EN 60950-1.

## Regulatory notices for telecommunication terminal equipment

This section contains regulatory information pertaining to products that contain telecommunication terminal equipment such as facsimile.

### Notice to users of the US telephone network: FCC requirements

This equipment complies with Part 68 of the FCC rules and the requirements adopted by the Administrative Council for Terminal Attachments (ACTA). On the back of this equipment is a label that contains, among other information, a product identifier in the format US:AAAEQ##TXXXX. If requested, this number must be provided to your telephone company.

This equipment uses the RJ-11C Universal Service Order Code (USOC) jack.

A plug and jack used to connect this equipment to the premises' wiring and telephone network must comply with the applicable FCC Part 68 rules and requirements adopted by the ACTA. A compliant telephone cord and modular plug is provided with this product. It is designed to be connected to a compatible modular jack that is also compliant. See your setup documentation for more information.

The Ringer Equivalence Number (REN) is used to determine the number of devices that may be connected to a telephone line. Excessive RENs on a telephone line may result in the devices not ringing in response to an incoming call. In most but not all areas, the sum of RENs should not exceed five (5.0). To be certain of the number of devices that may be connected to a line, as determined by the total RENs, contact your local telephone company. For products approved after July 23, 2001, the REN for this product is part of the product identifier that has the format US:AAAEQ##TXXXX. The digits represented by ## are the REN without a decimal point (for example, 03 is a REN of 0.3). For earlier products, the REN is shown separately on the label.

If this equipment causes harm to the telephone network, the telephone company will notify you in advance that temporary discontinuance of service may be required. If advance notice is not practical, the telephone company will notify the customer as soon as possible. You will also be advised of your right to file a complaint with the FCC.

The telephone company may make changes in its facilities, equipment, operations or procedures that could affect the operation of this equipment. If this happens, the telephone company will provide advance notice in order for you to make necessary modifications to maintain uninterrupted service.

If you experience trouble with this equipment, for repair or warranty information, contact Lexmark International, Inc. at [www.lexmark.com](http://www.lexmark.com) or your Lexmark representative. If the equipment is causing harm to the telephone network, the telephone company may request that you disconnect the equipment until the problem is resolved.

This equipment contains no user serviceable parts. For repair and warranty information, contact Lexmark International, Inc. See the previous paragraph for contact information.

Connection to party line service is subject to state tariffs. Contact the state public utility commission, public service commission, or corporation commission for information.

If your home has specially wired alarm equipment connected to the telephone line, ensure the installation of this equipment does not disable your alarm equipment. If you have questions about what will disable alarm equipment, consult your telephone company or a qualified installer.

Telephone companies report that electrical surges, typically lightning transients, are very destructive to customer terminal equipment connected to AC power sources. This has been identified as a major nationwide problem. It is recommended that the customer install an appropriate AC surge arrester in the AC outlet to which this device is connected. An appropriate AC surge arrester is defined as one that is suitably rated, and certified by UL (Underwriter's Laboratories), another NRTL (Nationally Recognized Testing Laboratory), or a recognized safety certification body in the country/region of use. This is to avoid damage to the equipment caused by local lightning strikes and other electrical surges.

The Telephone Consumer Protection Act of 1991 makes it unlawful for any person to use a computer or other electronic device, including fax machines, to send any message unless said message clearly contains in a margin at the top or bottom of each transmitted page or on the first page of the transmission, the date and time it is sent and an identification of the business or other entity, or other individual sending the message, and the telephone number of the sending machine or such business, other entity, or individual. (The telephone number provided may not be a 900 number or any other number for which charges exceed local or long-distance transmission charges.)

See your user documentation in order to program this information into your fax machine.

## **Notice to users of the Canadian telephone network**

This product meets the applicable Industry Canada technical specifications. The Ringer Equivalence Number (REN) is an indication of the maximum number of terminals allowed to be connected to a telephone interface. The terminus of an interface may consist of any combination of devices, subject only to the requirement that the sum of the RENs of all the devices does not exceed five. The modem REN is located on the rear of the equipment on the product labeling.

Telephone companies report that electrical surges, typically lightning transients, are very destructive to customer terminal equipment connected to AC power sources. This has been identified as a major nationwide problem. It is recommended that the customer install an appropriate AC surge arrester in the AC outlet to which this device is connected. An appropriate AC surge arrester is defined as one that is suitably rated, and certified by UL (Underwriter's Laboratories), another NRTL (Nationally Recognized Testing Laboratory), or a recognized safety certification body in the country/region of use. This is to avoid damage to the equipment caused by local lightning strikes and other electrical surges.

This equipment uses CA11A telephone jacks.

## **Avis réservé aux utilisateurs du réseau téléphonique du Canada**

Ce produit est conforme aux spécifications techniques d'Industrie Canada. Le numéro REN (ringer equivalence number : numéro d'équivalence de sonnerie) fournit une indication du nombre maximum de terminaux pouvant être connectés à l'interface téléphonique. En bout de ligne, le nombre d'appareils qui peuvent être connectés n'est pas directement limité, mais la somme des REN de ces appareils ne doit pas dépasser cinq. Le numéro REN du modem est indiqué sur l'étiquette produit située à l'arrière de l'équipement.

Les compagnies de téléphone constatent que les surtensions électriques, en particulier celles dues à la foudre, entraînent d'importants dégâts sur les terminaux privés connectés à des sources d'alimentation CA. Il s'agit-là d'un problème majeur d'échelle nationale. En conséquence, il vous est recommandé de brancher un parasurtenseur dans

la prise de courant à laquelle l'équipement est connecté. Utilisez un parasurtenseur répondant à des caractéristiques nominales satisfaisantes et certifié par le laboratoire d'assureurs UL (Underwriter's Laboratories), un autre laboratoire agréé de type NRTL (Nationally Recognized Testing Laboratory) ou un organisme de certification agréé dans votre région ou pays. Ceci prévient tout endommagement de l'équipement causé par les orages et autres surtensions électriques.

Cet équipement utilise des prises de téléphone CA11A.

## **Industry Canada (Canada)**

Under Industry Canada regulations, this radio transmitter may only operate using an antenna of a type and maximum (or lesser) gain approved for the transmitter by Industry Canada. To reduce potential radio interference to other users, the antenna type and its gain should be so chosen that the equivalent isotropically radiated power (EIRP) is not more than that necessary for successful communication.

This device complies with Industry Canada license-exempt RSS standards. Operation is subject to the following two conditions: (1) this device may not cause interference, and (2) this device must accept any interference, including interference that may cause undesired operation of the device.

To prevent radio interference to the licensed service, this device is intended to be operated indoors and away from windows to provide maximum shielding.

## **Industrie Canada (Canada)**

Selon la réglementation d'Industrie Canada, l'émetteur radio ne fonctionner qu'avec une antenne dont le type et le gain maximal (ou inférieur) ont été approuvés par Industrie Canada. Pour réduire les interférences radio potentielles auprès d'autres utilisateurs, le type d'antenne et son gain doivent être choisis de telle sorte que la puissance isotrope rayonnée équivalente (PIRE) ne soit pas supérieure à ce qui est nécessaire pour assurer la réussite de la communication.

Cet appareil est conforme aux normes RSS exemptes de licence d'Industrie Canada. Son fonctionnement est soumis aux deux conditions suivantes : (1) cet appareil ne doit pas causer d'interférences et (2) il doit accepter toutes les interférences, y compris les interférences pouvant entraîner un fonctionnement indésirable.

Pour éviter toute interférence radio au service sous licence, cet appareil est destiné à être utilisé à l'intérieur et à l'écart des fenêtres afin d'assurer une protection maximale.

## **Notice to users of the New Zealand telephone network**

The following are special conditions for the Facsimile User Instructions. The grant of a telepermit for any item of terminal equipment indicates only that Telecom has accepted that the item complies with minimum conditions for connection to its network. It indicates no endorsement of the product by Telecom, nor does it provide any sort of warranty. Above all, it provides no assurance that any item will work correctly in all respects with another item of telepermitted equipment of a different make or model, nor does it imply that any product is compatible with all of Telecom's network services.

This equipment shall not be set up to make automatic calls to the Telecom's 111 Emergency Service.

This equipment may not provide for the effective hand-over of a call to another device connected to the same line.

This equipment should not be used under any circumstances that may constitute a nuisance to other Telecom customers.

Some parameters required for compliance with Telecom's telepermit requirements are dependent on the equipment associated with this device. The associated equipment shall be set to operate within the following limits for compliance to Telecom's specifications:

- There shall be no more than 10 call attempts to the same number within any 30 minute period for any single manual call initiation, and
- The equipment shall go on-hook for a period of not less than 30 seconds between the end of one attempt and the beginning of the next call attempt.
- The equipment shall be set to ensure that automatic calls to different numbers are spaced such that there is not less than 5 seconds between the end of one call attempt and the beginning of another.

## Japanese telecom notice

The installed optional modem is in compliance with Japanese Telecommunication Law and has been Certified by JATE, with Certification Number A11-0160001.

	Lexmark International, Inc.
	LEX-M03-002
	A11-0160001JP

## Using this product in Switzerland

This product requires a Swiss billing tone filter (Lexmark part number 80D1877) to be installed on any line which receives metering pulses in Switzerland. The filter must be used, as metering pulses are present on all analog telephone lines in Switzerland.

## Utilisation de ce produit en Suisse

Cet appareil nécessite l'utilisation d'un filtre de tonalité de facturation suisse (n° de référence Lexmark : 80D1877) devant être installé sur toute ligne recevant des impulsions de comptage en Suisse. Ce filtre doit être utilisé pour toute installation car ces impulsions existent sur toutes les lignes téléphoniques suisses.

## Verwendung dieses Produkts in der Schweiz

Für dieses Produkt muss ein schweizerischer Billing Tone Filter zur Zählzeichenübertragung (Lexmark Teilenummer 80D1877) für jede Leitung installiert werden, über die in der Schweiz Zeitsteuertakte übertragen werden. Die Verwendung des Filters ist obligatorisch, da in allen analogen Telefonleitungen in der Schweiz Zeitsteuertakte vorhanden sind.

## Usò del prodotto in Svizzera

Questo prodotto richiede un filtro toni Billing svizzero, (codice Lexmark 80D1877) da installare su tutte le linee che ricevono impulsi remoti in Svizzera. È necessario utilizzare il filtro poiché gli impulsi remoti sono presenti su tutte le linee analogiche in Svizzera.

## Notice to Users in the European Union

Products bearing the CE mark are in conformity with the protection requirements of EC Council directives 2004/108/EC, 2006/95/EC, 1999/5/EC, and 2009/125/EC on the approximation and harmonization of the laws of the Member States relating to electromagnetic compatibility, safety of electrical equipment designed for use within certain voltage limits, radio equipment and telecommunications terminal equipment and on the ecodesign of energy-related products.

Compliance is indicated by the CE marking.



The manufacturer of this product is: Lexmark International, Inc., 740 West New Circle Road, Lexington, KY, 40550 USA. The authorized representative is: Lexmark International Technology Hungária Kft., 8 Lechner Ödön fasor, Millennium Tower III, 1095 Budapest HUNGARY, A declaration of conformity to the requirements of the Directives is available upon request from the Authorized Representative.

This product satisfies the Class B limits of EN 55022 and safety requirements of EN 60950-1.

Refer to the table at the end of the Notices section for further compliance information.

## Regulatory notices for wireless products

This section contains the following regulatory information pertaining to wireless products that contain transmitters, for example, but not limited to, wireless network cards or proximity card readers.

## Modular component notice

This product may contain the following modular component(s):

Lexmark Regulatory Type/Model LEX-M01-005, FCC ID: IYLLEXM01005; IC:2376A-M01005

## Exposure to radio frequency radiation

The radiated output power of this device is far below the radio frequency exposure limits of the FCC and other regulatory agencies. A minimum separation of 20 cm (8 inches) must be maintained between the antenna and any persons for this device to satisfy the RF exposure requirements of the FCC and other regulatory agencies.

## Notice to users in the European Union

This product is in conformity with the protection requirements of EC Council directives 2004/108/EC, 2006/95/EC, 1999/5/EC, 2009/125/EC, and 2011/65/EU on the approximation and harmonization of the laws of the Member States

relating to electromagnetic compatibility, safety of electrical equipment designed for use within certain voltage limits, radio equipment and telecommunications terminal equipment, the ecodesign of energy-related products, and on the restrictions of use of certain hazardous substances in electrical and electronic equipment.

Compliance is indicated by the CE marking.



The manufacturer of this product is: Lexmark International, Inc., 740 West New Circle Road, Lexington, KY, 40550 USA. The authorized representative is: Lexmark International Technology Hungária Kft., 8 Lechner Ödön fasor, Millennium Tower III, 1095 Budapest HUNGARY. A declaration of conformity to the requirements of the Directives is available upon request from the Authorized Representative.

This product satisfies the Class B limits of EN 55022 and safety requirements of EN 60950-1.

Products equipped with 2.4GHz Wireless LAN option are in conformity with the protection requirements of EC Council directives 2004/108/EC, 2006/95/EC, 1999/5/EC, 2009/125/EC, and 2011/65/EU on the approximation and harmonization of the laws of the Member States relating to electromagnetic compatibility, safety of electrical equipment designed for use within certain voltage limits, radio equipment and telecommunications terminal equipment, the ecodesign of energy-related products, and on the restrictions of use of certain hazardous substances in electrical and electronic equipment.

Compliance is indicated by the CE marking.



Operation is allowed in all EU and EFTA countries, but is restricted to indoor use only.

The manufacturer of this product is: Lexmark International, Inc., 740 West New Circle Road, Lexington, KY, 40550 USA. The authorized representative is: Lexmark International Technology Hungária Kft., 8 Lechner Ödön fasor, Millennium Tower III, 1095 Budapest HUNGARY. A declaration of conformity to the requirements of the Directives is available upon request from the Authorized Representative.

This product may be used in the countries indicated in the table below.

AT	BE	BG	CH	CY	CZ	DE	DK	EE
EL	ES	FI	FR	HR	HU	IE	IS	IT
LI	LT	LU	LV	MT	NL	NO	PL	PT
RO	SE	SI	SK	TR	UK			

Česky	Společnost Lexmark International, Inc. tímto prohlašuje, že výrobek tento výrobek je ve shodě se základními požadavky a dalšími příslušnými ustanoveními směrnice 1999/5/ES.
Dansk	Lexmark International, Inc. erklærer herved, at dette produkt overholder de væsentlige krav og øvrige relevante krav i direktiv 1999/5/EF.
Deutsch	Hiermit erklärt Lexmark International, Inc., dass sich das Gerät dieses Gerät in Übereinstimmung mit den grundlegenden Anforderungen und den übrigen einschlägigen Bestimmungen der Richtlinie 1999/5/EG befindet.

Ελληνική	ΜΕ ΤΗΝ ΠΑΡΟΥΣΑ Η LEXMARK INTERNATIONAL, INC. ΔΗΛΩΝΕΙ ΟΤΙ ΑΥΤΟ ΤΟ ΠΡΟΪΟΝ ΣΥΜΜΟΡΦΩΝΕΤΑΙ ΠΡΟΣ ΤΙΣ ΟΥΣΙΩΔΕΙΣ ΑΠΑΙΤΗΣΕΙΣ ΚΑΙ ΤΙΣ ΛΟΙΠΕΣ ΣΧΕΤΙΚΕΣ ΔΙΑΤΑΞΕΙΣ ΤΗΣ ΟΔΗΓΙΑΣ 1999/5/ΕΚ.
English	Hereby, Lexmark International, Inc., declares that this type of equipment is in compliance with the essential requirements and other relevant provisions of Directive 1999/5/EC.
Español	Por medio de la presente, Lexmark International, Inc. declara que este producto cumple con los requisitos esenciales y cualesquiera otras disposiciones aplicables o exigibles de la Directiva 1999/5/CE.
Eesti	Käesolevaga kinnitab Lexmark International, Inc., et seade see toode vastab direktiivi 1999/5/EÜ põhinõuetele ja nimetatud direktiivist tulenevatele muudele asjakohastele sätetele.
Suomi	Lexmark International, Inc. vakuuttaa täten, että tämä tuote on direktiivin 1999/5/EY oleellisten vaatimusten ja muiden sitä koskevien direktiivin ehtojen mukainen.
Français	Par la présente, Lexmark International, Inc. déclare que l'appareil ce produit est conforme aux exigences fondamentales et autres dispositions pertinentes de la directive 1999/5/CE.
Magyar	Alulírott, Lexmark International, Inc. nyilatkozom, hogy a termék megfelel a vonatkozó alapvető követelményeknek és az 1999/5/EC irányelv egyéb előírásainak.
Íslenska	Hér með lýsir Lexmark International, Inc. yfir því að þessi vara er í samræmi við grunnkröfur og aðrar kröfur, sem gerðar eru í tilskipun 1999/5/EC.
Italiano	Con la presente Lexmark International, Inc. dichiara che questo questo prodotto è conforme ai requisiti essenziali ed alle altre disposizioni pertinenti stabilite dalla direttiva 1999/5/CE.
Latviski	Ar šo Lexmark International, Inc. deklarē, ka šis izstrādājums atbilst Direktīvas 1999/5/EK būtiskajām prasībām un citiem ar to saistītajiem noteikumiem.
Lietuvių	Šiuo Lexmark International, Inc. deklaruoja, kad šis produktas atitinka esminius reikalavimus ir kitas 1999/5/EB direktyvos nuostatas.
Malti	Bil-preżenti, Lexmark International, Inc., jiddikjara li dan il-prodott huwa konformi mal-ħtiġijiet essenzjali u ma dispozizzjonijiet oħrajn relevanti li jinsabu fid-Direttiva 1999/5/KE.
Nederlands	Hierbij verklaart Lexmark International, Inc. dat het toestel dit product in overeenstemming is met de essentiële eisen en de andere relevante bepalingen van richtlijn 1999/5/EG.
Norsk	Lexmark International, Inc. erklærer herved at dette produktet er i samsvar med de grunnleggende krav og øvrige relevante krav i direktiv 1999/5/EF.
Polski	Niniejszym Lexmark International, Inc. oświadcza, że niniejszy produkt jest zgodny z zasadniczymi wymogami oraz pozostałymi stosownymi postanowieniami Dyrektywy 1999/5/EC.
Português	A Lexmark International Inc. declara que este este produto está conforme com os requisitos essenciais e outras disposições da Diretiva 1999/5/CE.
Slovensky	Lexmark International, Inc. týmto vyhlasuje, že tento produkt spĺňa základné požiadavky a všetky príslušné ustanovenia smernice 1999/5/ES.
Slovensko	Lexmark International, Inc. izjavlja, da je ta izdelek v skladu z bistvenimi zahtevami in ostalimi relevantnimi določili direktive 1999/5/ES.
Svenska	Härmed intygar Lexmark International, Inc. att denna produkt står i överensstämmelse med de väsentliga egenskapskrav och övriga relevanta bestämmelser som framgår av direktiv 1999/5/EG.

## **STATEMENT OF LIMITED WARRANTY FOR LEXMARK LASER PRINTERS, LEXMARK LED PRINTERS, AND LEXMARK MULTIFUNCTION LASER PRINTERS**

### **Lexmark International, Inc., Lexington, KY**

This limited warranty applies to the United States and Canada. For customers outside the U.S., refer to the country-specific warranty information that came with your product.

This limited warranty applies to this product only if it was originally purchased for your use, and not for resale, from Lexmark or a Lexmark Remarketer, referred to in this statement as "Remarketer."

### **Limited warranty**

Lexmark warrants that this product:

- Is manufactured from new parts, or new and serviceable used parts, which perform like new parts
- Is, during normal use, free from defects in material and workmanship

If this product does not function as warranted during the warranty period, contact a Remarketer or Lexmark for repair or replacement (at Lexmark's option).

If this product is a feature or option, this statement applies only when that feature or option is used with the product for which it was intended. To obtain warranty service, you may be required to present the feature or option with the product.

If you transfer this product to another user, warranty service under the terms of this statement is available to that user for the remainder of the warranty period. You should transfer proof of original purchase and this statement to that user.

### **Limited warranty service**

The warranty period starts on the date of original purchase as shown on the purchase receipt and ends 12 months later provided that the warranty period for any supplies and for any maintenance items included with the printer shall end earlier if it, or its original contents, are substantially used up, depleted, or consumed. Fuser Units, Transfer/Transport Units, Paper Feed items, if any, and any other items for which a Maintenance Kit is available are substantially consumed when the printer displays a "Life Warning" or "Scheduled Maintenance" message for such item.

To obtain warranty service you may be required to present proof of original purchase. You may be required to deliver your product to the Remarketer or Lexmark, or ship it prepaid and suitably packaged to a Lexmark designated location. You are responsible for loss of, or damage to, a product in transit to the Remarketer or the Lexmark designated location.

When warranty service involves the exchange of a product or part, the item replaced becomes the property of the Remarketer or Lexmark. The replacement may be a new or repaired item.

The replacement item assumes the remaining warranty period of the original product.

Replacement is not available to you if the product you present for exchange is defaced, altered, in need of a repair not included in warranty service, damaged beyond repair, or if the product is not free of all legal obligations, restrictions, liens, and encumbrances.

As part of your warranty service and/or replacement, Lexmark may update the firmware in your printer to the latest version. Firmware updates may modify printer settings and cause counterfeit and/or unauthorized products, supplies, parts, materials (such as toners and inks), software, or interfaces to stop working. Authorized use of genuine Lexmark products will not be impacted.



Before you present this product for warranty service, remove all print cartridges, programs, data, and removable storage media (unless directed otherwise by Lexmark).

For further explanation of your warranty alternatives and the nearest Lexmark authorized servicer in your area contact Lexmark on the World Wide Web.

Remote technical support is provided for this product throughout its warranty period. For products no longer covered by a Lexmark warranty, technical support may not be available or only be available for a fee.

### **Extent of limited warranty**

Lexmark does not warrant uninterrupted or error-free operation of any product or the durability or longevity of prints produced by any product.

Warranty service does not include repair of failures caused by:

- Modification or unauthorized attachments
- Accidents, misuse, abuse or use inconsistent with Lexmark user's guides, manuals, instructions or guidance
- Unsuitable physical or operating environment
- Maintenance by anyone other than Lexmark or a Lexmark authorized servicer
- Operation of a product beyond the limit of its duty cycle
- Use of printing media outside of Lexmark specifications
- Refurbishment, repair, refilling or remanufacture by a third party of products, supplies or parts
- Products, supplies, parts, materials (such as toners and inks), software, or interfaces not furnished by Lexmark

**TO THE EXTENT PERMITTED BY APPLICABLE LAW, NEITHER LEXMARK NOR ITS THIRD PARTY SUPPLIERS OR REMARKETERS MAKE ANY OTHER WARRANTY OR CONDITION OF ANY KIND, WHETHER EXPRESS OR IMPLIED, WITH RESPECT TO THIS PRODUCT, AND SPECIFICALLY DISCLAIM THE IMPLIED WARRANTIES OR CONDITIONS OF MERCHANTABILITY, FITNESS FOR A PARTICULAR PURPOSE, AND SATISFACTORY QUALITY. ANY WARRANTIES THAT MAY NOT BE DISCLAIMED UNDER APPLICABLE LAW ARE LIMITED IN DURATION TO THE WARRANTY PERIOD. NO WARRANTIES, EXPRESS OR IMPLIED, WILL APPLY AFTER THIS PERIOD. ALL INFORMATION, SPECIFICATIONS, PRICES, AND SERVICES ARE SUBJECT TO CHANGE AT ANY TIME WITHOUT NOTICE.**

### **Limitation of liability**

Your sole remedy under this limited warranty is set forth in this document. For any claim concerning performance or nonperformance of Lexmark or a Remarketer for this product under this limited warranty, you may recover actual damages up to the limit set forth in the following paragraph.

Lexmark's liability for actual damages from any cause whatsoever will be limited to the amount you paid for the product that caused the damages. This limitation of liability will not apply to claims by you for bodily injury or damage to real property or tangible personal property for which Lexmark is legally liable. **IN NO EVENT WILL LEXMARK BE LIABLE FOR ANY LOST PROFITS, LOST SAVINGS, INCIDENTAL DAMAGE, OR OTHER ECONOMIC OR CONSEQUENTIAL DAMAGES.** This is true even if you advise Lexmark or a Remarketer of the possibility of such damages. Lexmark is not liable for any claim by you based on a third party claim.

This limitation of remedies also applies to claims against any Suppliers and Remarketers of Lexmark. Lexmark's and its Suppliers' and Remarketers' limitations of remedies are not cumulative. Such Suppliers and Remarketers are intended beneficiaries of this limitation.

## Additional rights

Some states do not allow limitations on how long an implied warranty lasts, or do not allow the exclusion or limitation of incidental or consequential damages, so the limitations or exclusions contained above may not apply to you.

This limited warranty gives you specific legal rights. You may also have other rights that vary from state to state.

## Patent acknowledgment

The use of this product or service is subject to the reasonable, non-discriminatory terms in the Intellectual Property Rights (IPR) Disclosure of Certicom Corp. at the IETF for Elliptic Curve Cryptography (ECC) Cipher Suites for Transport Layer Security (TLS) implemented in the product or service.

The use of this product or service is subject to the reasonable, non-discriminatory terms in the Intellectual Property Rights (IPR) Disclosure of Certicom Corp. at the IETF for TLS Elliptic Curve Cipher Suites with SHA-256/382 and AES Galois Counter Mode (GCM) implemented in the product or service.

The use of this product or service is subject to the reasonable, non-discriminatory terms in the Intellectual Property Rights (IPR) Disclosure of Certicom Corp. at the IETF for TLS Suite B Profile for Transport Layer Security (TLS) implemented in the product or service.

The use of this product or service is subject to the reasonable, non-discriminatory terms in the Intellectual Property Rights (IPR) Disclosure of Certicom Corp. at the IETF for Addition of the Camellia Cipher Suites to Transport Layer Security (TLS) implemented in the product or service.

The use of certain patents in this product or service is subject to the reasonable, non-discriminatory terms in the Intellectual Property Rights (IPR) Disclosure of Certicom Corp. at the IETF for AES-CCM ECC Cipher Suites for TLS implemented in the product or service.

The use of this product or service is subject to the reasonable, non-discriminatory terms in the Intellectual Property Rights (IPR) Disclosure of Certicom Corp. at the IETF for IKE and IKEv2 Authentication Using the Elliptic Curve Digital Signature Algorithm (ECDSA) implemented in the product or service.

The use of this product or service is subject to the reasonable, non-discriminatory terms in the Intellectual Property Rights (IPR) Disclosure of Certicom Corp. at the IETF for Suite B Cryptographic Suites for IPsec implemented in the product or service.

The use of this product or service is subject to the reasonable, non-discriminatory terms in the Intellectual Property Rights (IPR) Disclosure of Certicom Corp. at the IETF for Algorithms for Internet Key Exchange version 1 (IKEv1) implemented in the product or service.

# Index

## Numerics

- 250-sheet tray
  - loading 42
- 550-sheet tray
  - installing 33
  - loading 42
- 650-sheet duo tray
  - installing 33
  - loading 42, 46

## Symbols

- [Color] cartridge low [88.xy] 251
- [Color] cartridge nearly low [88.xy] 251
- [Color] cartridge very low, [x] estimated pages remain [88.xy] 251
- [Type] imaging kit low [84.xy] 263
- [Type] imaging kit nearly low [84.xy] 263
- [Type] imaging kit very low, [x] estimated pages remain [84.xy] 263
- [x]-page jam, clear manual feeder [251.xx] 246
- [x]-page jam, clear multipurpose feeder [250.xx] 247
- [x]-page jam, clear standard bin [203.xx] 237
- [x]-page jam, open automatic feeder top cover [28y.xx] 249
- [x]-page jam, open front door [20y.xx] 243
- [x]-page jam, open front door to clear duplex [23y.xx] 244
- [x]-page jam, open front door to clear fuser [20y.xx] 240
- [x]-page jam, open tray [x] [24y.xx] 245

## A

- accessing the Embedded Web Server 19
- Active NIC menu 131
- adapter plug 98
- adding hardware options
  - print driver 37

## ADF

- copying using 69
- Adjusting color 250
- adjusting copy quality 74
- adjusting printer display brightness 198
- adjusting Sleep mode 197
- adjusting toner darkness 63
- administrator settings
  - Embedded Web Server 232
- advanced options, touch-screen copy 80
  - e-mail 88
  - fax 111
  - FTP 118
- answering machine
  - setting up 91
- AppleTalk menu 136
- applications
  - home screen 21
  - understanding 20
- attaching cables 35
- available internal options 26
- avoiding jams 58
- avoiding paper jams 235

## B

- black-and-white printing 62
- blocking junk faxes 107
- buttons, printer control panel 14
- buttons, touch screen
  - using 17

## C

- cables
  - Ethernet 35
  - USB 35
- canceling a print job
  - from a computer 68
  - from the printer control panel 68
- canceling an e-mail 86
- cannot open Embedded Web Server 311
- Card Copy
  - setting up 22
- card stock
  - loading 47
  - tips 55

- Change [paper source] to [custom string] 250
- Change [paper source] to [custom type name] 250
- Change [paper source] to [paper type] [paper size] 250
- changing output file type
  - e-mailing 85
- checking an unresponsive printer 264
- checking status of parts and supplies 207
- checking the status of parts and supplies 207
- checking the virtual display using the Embedded Web Server 232
- cleaning
  - exterior of the printer 205
  - interior of the printer 205
  - scanner glass 206
- cleaning the printer 205
- Close door 250
- Close flatbed cover and load originals if restarting job [2yy.xx] 251
- collate
  - copy options 79
- collating copies 75
- color quality troubleshooting
  - color of print and color on computer screen do not match 296
  - prints on color transparencies appear dark when projected 296
- color quality, troubleshooting
  - print appears tinted 297
- Complex page, some data may not have printed [39] 251
- confidential data
  - information on securing 204
- confidential jobs
  - modifying print settings 67
- confidential print jobs 66
  - printing from a Macintosh computer 66
  - printing from Windows 66
- Confidential Print menu 141

- Configuration change, some held jobs were not restored [57] 251
  - configuration information
    - wireless network 38
  - configurations
    - printer 11
  - configuring
    - multiple printers 234
    - supply notifications, imaging kit 233
    - supply notifications, maintenance kit 233
    - supply notifications, toner cartridge 233
    - supply notifications, waste toner bottle 233
  - configuring e-mail settings 82
  - configuring supply notifications from the Embedded Web Server 233
  - connecting printer to distinctive ring service 102
  - connecting to a wireless network
    - using PIN (Personal Identification Number) method 39
    - using Push Button Configuration method 39
    - using the Embedded Web Server 40
    - using wireless setup wizard 39
  - conservation settings
    - brightness, adjusting 198
    - conserving supplies 195
    - Eco-Mode 196
    - Hibernate mode 197
    - Hibernate Timeout 197
    - Quiet Mode 196
    - Schedule Power Modes 198
    - Sleep Mode 197
  - conserving supplies 195
  - contacting customer support 313
  - content
    - e-mail settings 86
  - content source
    - e-mail settings 86
    - fax options 110
  - content type
    - e-mail settings 86
    - fax options 110
  - control panel, printer
    - indicator light 16
    - Sleep button light 16
  - controller board
    - accessing 26
  - copies
    - copy options 79
  - copy job, canceling
    - using the ADF 78
    - using the scanner glass 78
  - copy options
    - collate 79
    - copies 79
    - darkness 79
    - Save As Shortcut 80
    - sides (duplex) 79
  - copy quality
    - adjusting 74
  - copy screen
    - advanced options 80
    - content source 79
    - content type 79
    - options 78, 79, 80
  - Copy Settings menu 152
  - copy troubleshooting
    - copier does not respond 297
    - partial document or photo
      - copies 297
    - poor copy quality 298
    - poor scanned image quality 308
    - scanner unit does not close 298, 308
  - copying
    - adding an overlay message 77
    - adjusting quality 74
    - canceling a copy job 78
    - collating copies 75
    - creating shortcuts using the printer control panel 71
    - custom job 76
    - different paper sizes 72
    - enlarging 74
    - inserting a header or footer 77
    - multiple pages on one sheet 76
    - on both sides of the paper (duplexing) 73
    - on letterhead 71
    - on transparencies 70
    - photos 70
    - placing separator sheets between copies 75
    - quick copy 69
    - reducing 74
    - selecting a tray 72
    - to a different size 72
    - using the ADF 69
    - using the scanner glass 70
  - copying different paper sizes 72
  - copying multiple pages on one sheet 76
  - copying on both sides of the paper (duplexing) 73
  - copying on transparencies 70
  - creating a fax destination shortcut
    - using the Embedded Web Server 106
  - creating an FTP shortcut
    - using the Embedded Web Server 112
  - custom name
    - configuring 51
  - Custom Names menu 128
  - custom paper type
    - assigning 50
  - custom paper type name
    - creating 50
  - Custom Scan Sizes menu 129
  - Custom Type [x]
    - changing name 50
    - changing paper type 51
  - Custom Types menu 128
  - customer support
    - contacting 313
- ## D
- darkness
    - copy options 79
    - e-mail options 87
    - fax options 110
    - scan options 117
  - date and time, fax
    - setting 103
  - daylight saving time, setting 103
  - Default Source menu 120
  - Defective flash detected [51] 252
  - delayed send
    - fax options 110
  - developer unit
    - replacing 214, 224
  - device and network settings information
    - erasing 202
  - different paper sizes, copying 72
  - Digital Subscriber Line (DSL)
    - fax setup 95
  - digital telephone service
    - fax setup 97

- directory list
    - printing 68
  - Disk full [62] 252
  - Disk must be formatted for use in this device 252
  - disk wiping 203
  - display troubleshooting
    - printer display is blank 264
  - display, printer control panel 14
    - adjusting brightness 198
  - disposing of printer hard disk 201
  - distinctive ring service, fax
    - connecting to 102
  - documents, printing
    - from Macintosh 62
    - from Windows 62
  - DSL filter 95
  - duplexing 73
- E**
- Eco-Mode setting 196
  - Edit Security Setups menu 139
  - embedded solutions information
    - erasing 202
  - Embedded Web Server 233
    - accessing 19
    - adjusting brightness 198
    - administrator settings 232
    - checking the status of parts 207
    - checking the status of supplies 207
    - copying settings to other printers 234
    - creating a fax destination shortcut 106
    - creating an FTP shortcut 112
    - creating e-mail shortcuts 83
    - initial fax setup 90
    - modifying confidential print settings 67
    - networking settings 232
    - problem accessing 311
    - scanning to a computer using 115
    - setting up e-mail alerts 232
  - Embedded Web Server — Security: Administrator's Guide
    - where to find 232
  - Embedded Web Server—Security: Administrator's Guide
    - where to find 204
  - emission
    - notices 316, 319, 320, 321, 325
  - encrypting the printer hard disk 203
  - enlarging a copy 74
  - envelopes
    - loading 45, 47
    - tips on using 54
  - environmental settings
    - conserving supplies 195
    - Eco-Mode 196
    - Hibernate mode 197
    - Hibernate Timeout 197
    - printer display brightness, adjusting 198
    - Quiet Mode 196
    - Schedule Power Modes 198
    - Sleep Mode 197
  - Erase Temporary Data Files menu 141
  - erasing hard disk memory 203
  - erasing non-volatile memory 202
  - erasing volatile memory 202
  - Error reading USB drive. Remove USB. 252
  - Error reading USB hub. Remove hub. 252
  - Ethernet network
    - preparing to set up for Ethernet printing 37
  - Ethernet port 35
  - Ethernet setup
    - preparing for an 37
  - exporting a configuration using the Embedded Web Server 25
  - EXT port 35
  - exterior of the printer
    - cleaning 205
  - e-mail
    - canceling 86
  - e-mail alerts
    - low supply levels 232
    - paper jam 232
    - setting up 232
  - e-mail function
    - setting up 82
  - e-mail options
    - darkness 87
    - message 86
    - original size 86
    - page setup 87
    - recipient(s) 86
    - resolution 86
  - Save As Shortcut 88
  - Send As 87
  - subject 86
  - e-mail screen
    - advanced options 88
    - options 86, 87
  - E-mail Settings menu 167
  - e-mail shortcuts, creating
    - using the Embedded Web Server 83
  - e-mail, sending
    - using a shortcut number 84
    - using the address book 84
  - e-mailing
    - adding message line 85
    - adding subject line 85
    - configuring e-mail settings 82
    - creating shortcuts using the Embedded Web Server 83
    - creating shortcuts using the printer control panel 83
    - setting up e-mail function 82
    - using a shortcut number 84
    - using the address book 84
    - using the printer control panel 84
- F**
- factory defaults
    - restoring 234
  - FAQ about color printing 294
  - fax
    - sending 105
    - sending at a scheduled time 105
  - fax and e-mail functions
    - setting up 304
  - fax and e-mail functions are not set up 304
  - fax log
    - viewing 107
  - Fax Mode (Analog Fax Setup) menu 157
  - Fax Mode (Fax Server Setup) menu 165
  - fax name, setting 102
  - fax number, setting 102
  - fax options
    - content source 110
    - content type 110
    - darkness 110
    - delayed send 110
    - page setup 110
    - resolution 109

- scan preview 110
- Fax partition inoperative. Contact system administrator. 252
- fax screen
  - advanced options 111
  - options 110
- Fax server 'To Format' not set up. Contact system administrator. 252
- fax setup
  - country- or region-specific 98
  - digital telephone service 97
  - DSL connection 95
  - standard telephone line connection 91
  - VoIP 96
- Fax Station Name not set up. Contact system administrator. 253
- Fax Station Number not set up. Contact system administrator. 253
- fax troubleshooting
  - caller ID is not shown 300
  - can receive but not send faxes 304
  - can send but not receive faxes 303
  - cannot send or receive a fax 301
  - received fax has poor print quality 305
- faxing
  - blocking junk faxes 107
  - canceling a fax job 108
  - changing resolution 106
  - configuring the printer to observe daylight saving time 103
  - creating shortcuts using the Embedded Web Server 106
  - creating shortcuts using the printer control panel 106
  - distinctive ring service 102
  - fax setup 90
  - forwarding faxes 109
  - holding faxes 108
  - making a fax lighter or darker 107
  - sending a fax at a scheduled time 105
  - sending using the printer control panel 103
  - setting the date and time 103
  - setting the fax number 102
  - setting the outgoing fax name 102
  - viewing a fax log 107
- FCC notices 319, 321, 325

- file name
  - scan options 116
- finding more information about the printer 9
- finding printer IP address 19
- Finishing menu 183
- firmware card 26
- flash drive
  - printing from 64
- Flash Drive menu 176
- flash drives
  - supported file types 65
- font sample list
  - printing 68
- Forms and Favorites
  - setting up 21
- forwarding faxes 109
- FTP
  - FTP options 116
- FTP address
  - creating shortcuts using the printer control panel 113
- FTP address, scanning to
  - using a shortcut number 113
  - using the printer control panel 113
- FTP options
  - FTP 116
- FTP screen
  - advanced options 118
  - options 117
- FTP Settings menu 172

## G

- General Settings menu 145
- green settings
  - Eco-Mode 196
  - Hibernate mode 197
  - Hibernate Timeout 197
  - Quiet Mode 196
  - Schedule Power Modes 198

## H

- hardware options, adding
  - print driver 37
- held jobs 66
  - printing from a Macintosh computer 66
  - printing from Windows 66
- Help menu 194

- Hibernate mode
  - using 197
- Hibernate Timeout
  - setting 197
- hiding icons on the home screen 20
- holding faxes 108
- home screen
  - customizing 20
  - hiding icons 20
  - showing icons 20
- home screen applications
  - configuring 21
  - finding information 21
- home screen buttons and icons
  - description 14
- HTML menu 192

## I

- icons on the home screen
  - hiding 20
  - showing 20
- Image menu 193
- imaging kit
  - replacing 214
- imaging kits
  - ordering 209
- importing a configuration
  - using the Embedded Web Server 25
- Incompatible tray [x] [59] 253
- Incorrect paper size, open [paper source] [34] 253
- indicator light
  - printer control panel 14
- individual settings information
  - erasing 202
- initial fax setup 90
  - using the Embedded Web Server 90
- Insert Tray [x] 253
- inserting a header or footer 77
- installing an optional card 31
- installing options
  - order of installation 32
- installing printer 36
- Insufficient memory for Flash Memory Defragment operation [37] 253
- Insufficient memory to collate job [37] 254
- Insufficient memory to support Resource Save feature [35] 254

Insufficient memory, some Held Jobs were deleted [37] 253  
 Insufficient memory, some held jobs will not be restored [37] 254  
 interior of the printer  
   cleaning 205  
 internal options 26  
 IP address of computer  
   finding 19  
 IP address, printer  
   finding 19  
 IPv6 menu 134

**J**

jams  
   avoiding 235  
   locating doors and trays 236  
   locations 236  
   messages 236  
 jams, clearing  
   duplex 244  
   front door 243  
   fuser 240  
   in automatic document feeder top cover 249  
   in manual feeder 246  
   in standard bin 237  
   in the multipurpose feeder 247  
   Tray 1 245  
   Tray 2 245  
 Job Accounting menu 186

**K**

keypad  
   printer control panel 14

**L**

labels, paper  
   tips 54  
 letterhead  
   copying on 71  
   loading, multipurpose feeder 52  
   loading, trays 52  
 line filter 95  
 LINE port 35  
 linking trays 49, 50  
 Load [paper source] with [custom string] 254  
 Load [paper source] with [custom type name] 254

Load [paper source] with [paper size] 255  
 Load [paper source] with [paper type] [paper size] 255  
 Load Manual Feeder with [custom string] 255  
 Load Manual Feeder with [custom type name] 255  
 Load Manual Feeder with [paper size] 256  
 Load manual feeder with [paper type] [paper size] 256  
 loading  
   250-sheet tray 42  
   550-sheet tray 42  
   650-sheet duo tray 42, 46  
   card stock 47  
   envelopes 45, 47  
   manual feeder 45  
   multipurpose feeder 47  
   transparencies 47  
 loading letterhead  
   paper orientation 52  
 lock, security 201

**M**

maintenance kit  
   ordering 210  
 Maintenance kit low [80.xy] 256  
 Maintenance kit nearly low [80.xy] 256  
 Maintenance kit very low, [x] estimated pages remain [80.xy] 256  
 making copies using paper from selected tray 72  
 manual feeder  
   loading 45  
 Max Speed and Max Yield using 63  
 memory  
   types installed on printer 201  
 memory card 26  
   installing 29  
   troubleshooting 267  
 Memory full [38] 256  
 Memory full, cannot print faxes 257  
 Memory full, cannot send faxes 257  
 menu settings  
   loading on multiple printers 234

menu settings page  
   printing 41  
 menus  
   Active NIC 131  
   AppleTalk 136  
   Confidential Print 141  
   Copy Settings 152  
   Custom Names 128  
   Custom Scan Sizes 129  
   Custom Types 128  
   Default Source 120  
   Edit Security Setups 139  
   Erase Temporary Data Files 141  
   E-mail Settings 167  
   Fax Mode (Analog Fax Setup) 157  
   Fax Mode (Fax Server Setup) 165  
   Finishing 183  
   Flash Drive 176  
   FTP Settings 172  
   General Settings 145  
   Help 194  
   HTML 192  
   Image 193  
   IPv6 134  
   Job Accounting 186  
   list of 119  
   Miscellaneous Security Settings 140  
   Network [x] 131  
   Network Card 133  
   Network Reports 132  
   OCR Settings 181  
   Paper Loading 127  
   Paper Size/Type 121  
   Paper Texture 124  
   Paper Weight 125  
   PCL Emul 190  
   PDF 189  
   PostScript 189  
   Quality 184  
   Reports 130  
   Security Audit Log 142  
   Set Date/Time 143  
   Setup 181  
   SMTP Setup menu 138  
   Standard Network 131  
   Standard USB 136  
   Substitute Size 124  
   Supplies 120  
   TCP/IP 133  
   Universal Setup 129  
   Utilities 188

- Wireless 135
- XPS 189
- message
  - e-mail options 86
- Miscellaneous Security Settings
- menu 140
- mobile device
  - printing from 66
- moving the printer 10, 230
- Multi Send
  - adding a profile 23
  - setting up 23
- multipurpose feeder
  - loading 47
- MyShortcut
  - about 22

## N

- Network [x] menu 131
- Network [x] software error [54] 257
- Network Card menu 133
- Network Reports menu 132
- network settings
  - Embedded Web Server 232
- network setup page
  - printing 41
- Networking Guide
  - where to find 232
- No analog phone line connected to modem, fax is disabled. 257
- noise emission levels 316
- Non-Lexmark [color] [supply type], see User's Guide [33.xy] 257
- non-volatile memory 201
  - erasing 202
- Not enough free space in flash memory for resources [52] 258
- notices 315, 316, 317, 318, 319, 320, 321, 322, 323, 324, 325, 326
- number of remaining pages
  - estimate 207

## O

- OCR Settings menu 181
- optional card
  - installing 31
- options
  - 550-sheet tray 33
  - 650-sheet duo tray 33
  - firmware cards 26

- memory card 29
- memory cards 26
- options, copy screen
  - copy from 78
  - scale 79
- options, touch-screen
  - copy 78, 80
  - e-mail 86, 87
  - fax 110
  - FTP 117
- ordering
  - imaging kits 209
  - maintenance kit 210
  - toner cartridges 208
  - waste toner bottle 210
- original size
  - e-mail options 86
  - scan options 116
- output file type
  - changing 85
  - scan image 117

## P

- page setup
  - e-mail options 87
  - fax options 110
  - scan options 118
- paper
  - characteristics 55
  - different sizes, copying 72
  - letterhead 57
  - preprinted forms 57
  - recycled 57
  - saving 76
  - selecting 56
  - storing 58
  - unacceptable 56
  - Universal size setting 42
  - using recycled 195
- paper feed troubleshooting
  - message remains after jam is cleared 269
- paper jams
  - avoiding 235
- paper jams, clearing
  - duplex 244
  - front door 243
  - fuser 240
  - in automatic document feeder top cover 249
  - in manual feeder 246
  - in standard bin 237
  - in the multipurpose feeder 247
  - Tray 1 245
  - Tray 2 245
- Paper Loading menu 127
- paper size
  - setting 42
- Paper Size/Type menu 121
- paper sizes
  - supported by the printer 58
- Paper Texture menu 124
- paper type
  - setting 42
- paper types
  - supported by printer 60
- Paper Weight menu 125
- paper weights
  - supported by printer 60
- parts
  - checking status 207
  - checking, on the printer control panel 207
  - checking, using the Embedded Web Server 207
  - using genuine Lexmark 208
- PCL Emul menu 190
- PDF menu 189
- Personal Identification Number method
  - using 39
- phone splitter 96
- photos
  - copying 70
- placing separator sheets between copies 75
- PostScript menu 189
- power cord socket 35
- preparing to set up the printer on an Ethernet network 37
- print driver
  - hardware options, adding 37
- print irregularities 282
- print job
  - canceling, from computer 68
- print quality
  - cleaning the scanner glass 206
  - replacing a developer unit 224
  - replacing imaging kit 214
  - replacing the waste toner bottle 211
- print quality troubleshooting
  - blank pages 285
  - characters have jagged edges 277



- clipped pages or images 277
- gray background on prints 278
- horizontal voids appear on prints 279
- print irregularities 282
- print is too dark 283
- print is too light 284
- printer is printing solid black pages 286
- repeating print defects 287
- shadow images appear on prints 287
- skewed print 288
- streaked horizontal lines appear on prints 288
- streaked vertical lines appear on prints 290
- toner fog or background shading appears on prints 291
- toner rubs off 291
- toner specks appear on prints 292
- transparency print quality is poor 292
- uneven print density 292
- vertical voids appear on prints 293
- print troubleshooting
  - error reading flash drive 271
  - held jobs do not print 270
  - incorrect characters print 271
  - incorrect margins on prints 280
  - jammed pages are not reprinted 268
  - job prints from wrong tray 272
  - job prints on wrong paper 272
  - jobs do not print 274
  - Large jobs do not collate 272
  - multiple-language PDF files do not print 273
  - paper curl 281
  - paper frequently jams 268
  - print job takes longer than expected 275
  - printing slows down 273
  - tray linking does not work 276
  - unexpected page breaks occur 276
- printer 36
  - configurations 11
  - minimum clearances 10
  - models 11
  - moving 10, 230
    - selecting a location 10
    - shipping 231
- printer control panel
  - adjusting brightness 198
  - factory defaults, restoring 234
  - indicator light 16
  - parts 14
  - Sleep button light 16
  - using 14
- printer control panel, virtual display
  - using the Embedded Web Server 232
- Printer had to restart. Last job may be incomplete. 258
- printer hard disk
  - disposing of 201
  - encrypting 203
  - wiping 203
- printer hard disk encryption 203
- printer hard disk memory
  - erasing 203
- printer information
  - where to find 9
- printer IP address
  - finding 19
- printer is printing blank pages 285
- printer message
  - [x]-page jam, open front door to clear duplex [23y.xx] 244
- printer messages
  - [Color] cartridge low [88.xy] 251
  - [Color] cartridge nearly low [88.xy] 251
  - [Color] cartridge very low, [x] estimated pages remain [88.xy] 251
  - [Type] imaging kit low [84.xy] 263
  - [Type] imaging kit nearly low [84.xy] 263
  - [Type] imaging kit very low, [x] estimated pages remain [84.xy] 263
  - [x]-page jam, clear manual feeder [251.xx] 246
  - [x]-page jam, clear multipurpose feeder [250.xx] 247
  - [x]-page jam, clear standard bin [203.xx] 237
  - [x]-page jam, open automatic feeder top cover [28y.xx] 249
  - [x]-page jam, open front door [20y.xx] 243
  - [x]-page jam, open front door to clear fuser [20y.xx] 240
  - [x]-page jam, open tray [x] [24y.xx] 245
- Adjusting color 250
- Change [paper source] to [custom string] 250
- Change [paper source] to [custom type name] 250
- Change [paper source] to [paper type] [paper size] 250
- Close door 250
- Close flatbed cover and load originals if restarting job [2yy.xx] 251
- Complex page, some data may not have printed [39] 251
- Configuration change, some held jobs were not restored [57] 251
- Defective flash detected [51] 252
- Disk full [62] 252
- Disk must be formatted for use in this device 252
- Error reading USB drive. Remove USB. 252
- Error reading USB hub. Remove hub. 252
- Fax partition inoperative. Contact system administrator. 252
- Fax server 'To Format' not set up. Contact system administrator. 252
- Fax Station Name not set up. Contact system administrator. 253
- Fax Station Number not set up. Contact system administrator. 253
- Incompatible tray [x] [59] 253
- Incorrect paper size, open [paper source] [34] 253
- Insert Tray [x] 253
- Insufficient memory for Flash Memory Defragment operation [37] 253
- Insufficient memory to collate job [37] 254
- Insufficient memory to support Resource Save feature [35] 254

- Insufficient memory, some Held Jobs were deleted [37] 253
  - Insufficient memory, some held jobs will not be restored [37] 254
  - Load [paper source] with [custom string] 254
  - Load [paper source] with [custom type name] 254
  - Load [paper source] with [paper size] 255
  - Load [paper source] with [paper type] [paper size] 255
  - Load Manual Feeder with [custom string] 255
  - Load Manual Feeder with [custom type name] 255
  - Load Manual Feeder with [paper size] 256
  - Load manual feeder with [paper type] [paper size] 256
  - Maintenance kit low [80.xy] 256
  - Maintenance kit nearly low [80.xy] 256
  - Maintenance kit very low, [x] estimated pages remain [80.xy] 256
  - Memory full [38] 256
  - Memory full, cannot print faxes 257
  - Memory full, cannot send faxes 257
  - Network [x] software error [54] 257
  - No analog phone line connected to modem, fax is disabled. 257
  - Non-Lexmark [color] [supply type], see User's Guide [33.xy] 257
  - Not enough free space in flash memory for resources [52] 258
  - Printer had to restart. Last job may be incomplete. 258
  - Reinstall missing or unresponsive [color] cartridge [31.xy] 258
  - Reload printed pages in Tray [x] 258
  - Remove defective disk [61] 258
  - Remove packaging material, [area name] 259
  - Remove paper from standard output bin 259
  - Replace [color] cartridge, 0 estimated pages remain [88.xy] 259
  - Replace [color] cartridge, printer region mismatch [42.xy] 259
  - Replace [type] imaging kit, 0 estimated pages remain [84.xy] 260
  - Replace all originals if restarting job. 259
  - Replace defective [type] imaging kit [31.xy] 260
  - Replace jammed originals if restarting job. 260
  - Replace maintenance kit, 0 estimated pages remain [80.xy] 260
  - Replace missing [type] imaging kit [31.xy] 260
  - Replace missing or unresponsive [type] imaging kit [31.xy] 258
  - Replace missing waste toner bottle [82.xy] 260
  - Replace unsupported [color] cartridge [32.xy] 261
  - Replace unsupported [type] imaging kit [32.xy] 261
  - Replace waste toner bottle [82.xy] 261
  - Restore held jobs? 261
  - Scanner automatic feeder cover open 261
  - Scanner disabled by admin [840.01] 261
  - Scanner disabled. Contact system administrator if problem persists. [840.02] 261
  - Scanner jam, remove all originals from the scanner [2yy.xx] 261
  - Scanner jam, remove jammed originals from the scanner [2yy.xx] 262
  - SMTP server not set up. Contact system administrator. 262, 264
  - Some held jobs were not restored 262
  - Standard network software error [54] 262
  - Standard USB port disabled [56] 262
  - Supply needed to complete job 262
  - Too many flash options installed [58] 262
  - Too many trays attached [58] 263
  - Unformatted flash detected [53] 263
  - Unsupported USB hub, please remove 252
  - Waste toner bottle nearly full [82.xy] 263
  - printer options troubleshooting
    - internal option is not detected 266
    - memory card 267
    - tray problems 267
  - printer problems, solving basic 264
  - printer security
    - information on 204
  - printing
    - black-and-white 62
    - canceling, from the printer control panel 68
    - directory list 68
    - font sample list 68
    - forms 62
    - from a mobile device 66
    - from flash drive 64
    - from Macintosh 62
    - from Windows 62
    - Max Speed and Max Yield 63
    - menu settings page 41
    - network setup page 41
    - printing a directory list 68
    - printing a document 62
    - printing a font sample list 68
    - printing a menu settings page 41
    - printing a network setup page 41
    - printing confidential and other held jobs
      - from a Macintosh computer 66
      - from Windows 66
    - printing forms 62
    - printing from a flash drive 64
    - printing from a mobile device 66
    - printing in black and white 62
    - publications
      - where to find 9
    - Push Button Configuration method using 39
- Q**
- Quality menu 184
  - Quiet Mode 196

**R**

- recipient(s)
    - e-mail options 86
  - recycled paper
    - using 57, 195
  - recycling
    - Lexmark packaging 199
    - Lexmark products 199
    - toner cartridges 199
  - reducing a copy 74
  - reducing noise 196
  - Reinstall missing or unresponsive [color] cartridge [31.xy] 258
  - Reload printed pages in Tray [x] 258
  - remaining pages, number of
    - estimate 207
  - Remote Operator Panel
    - setting up 24
  - Remove defective disk [61] 258
  - Remove packaging material, [area name] 259
  - Remove paper from standard output bin 259
  - repeat print jobs 66
    - printing from a Macintosh computer 66
    - printing from Windows 66
  - repeating print defects 287
  - Replace [color] cartridge, 0 estimated pages remain [88.xy] 259
  - Replace [color] cartridge, printer region mismatch [42.xy] 259
  - Replace [type] imaging kit, 0 estimated pages remain [84.xy] 260
  - Replace all originals if restarting job. 259
  - Replace defective [type] imaging kit [31.xy] 260
  - Replace jammed originals if restarting job. 260
  - Replace maintenance kit, 0 estimated pages remain [80.xy] 260
  - Replace missing [type] imaging kit [31.xy] 260
  - Replace missing or unresponsive [type] imaging kit [31.xy] 258
  - Replace missing waste toner bottle [82.xy] 260
  - Replace unsupported [color] cartridge [32.xy] 261
  - Replace unsupported [type] imaging kit [32.xy] 261
  - Replace waste toner bottle [82.xy] 261
  - reports
    - viewing 232
  - Reports menu 130
  - reserve print jobs 66
    - printing from a Macintosh computer 66
    - printing from Windows 66
  - resolution
    - e-mail options 86
    - scan options 117
  - resolution, fax
    - changing 106
  - Restore held jobs? 261
  - restoring factory default settings 234
  - RJ-11 adapter 98
- S**
- safety information 7, 8
  - Save As Shortcut
    - copy options 80
    - e-mail options 88
    - scan options 118
  - saving paper 76
  - scan image
    - output file type 117
  - scan options
    - darkness 117
    - file name 116
    - original size 116
    - page setup 118
    - resolution 117
  - Save As Shortcut 118
  - Scan Preview 118
  - Send As 117
  - Scan Preview
    - scan options 118
  - scan preview
    - fax options 110
  - scan screen
    - content source 117
    - content type 117
  - Scan to Computer
    - setting up 116
  - Scan to Network
    - setting up 23
    - using 112
  - scan troubleshooting
    - cannot scan from a computer 307
    - partial document or photo scans 309
    - scan job was not successful 307
    - scanner unit does not
      - close 298, 308
    - scanning takes too long or freezes the computer 308
  - scanner
    - automatic document feeder (ADF) 13
    - functions 12
    - scanner glass 13
  - Scanner automatic feeder cover open 261
  - Scanner disabled by admin [840.01] 261
  - Scanner disabled. Contact system administrator if problem persists. [840.02] 261
  - scanner glass
    - cleaning 206
    - copying using 70
  - Scanner jam, remove all originals from the scanner [2yy.xx] 261
  - Scanner jam, remove jammed originals from the scanner [2yy.xx] 262
  - scanning
    - from a flash drive 116
    - quick copy 69
    - to a computer using the
      - Embedded Web Server 115
    - to an FTP address 113, 114
  - scanning to a computer 116
    - using the Embedded Web Server 115
  - scanning to a flash drive 116
  - scanning to an FTP address
    - creating shortcuts using the computer 112
    - using a shortcut number 113
    - using the address book 114
    - using the printer control panel 113
  - scanning to network destinations 112

- Schedule Power Modes
    - using 198
  - security
    - modifying confidential print settings 67
  - Security Audit Log menu 142
  - security lock 201
  - security lock port 35
  - security settings information
    - erasing 202
  - security Web page
    - printer security information 204
  - selecting a location for the printer 10
  - selecting paper 56
  - Send As
    - e-mail options 87
    - scan options 117
  - sending a fax using the computer 104
  - sending a fax using the printer control panel 103
  - sending an e-mail using the printer control panel 84
  - sending fax
    - using shortcuts 104
    - using the address book 105
  - sending fax at a scheduled time 105
  - sending fax using the address book 105
  - Set Date/Time menu 143
  - setting
    - paper size 42
    - paper type 42
    - TCP/IP address 133
  - setting Hibernate Timeout 197
  - setting the fax number 102
  - setting the outgoing fax name 102
  - setting the Universal paper size 42
  - setting up e-mail alerts 232
  - setting up fax
    - country- or region-specific 98
    - digital telephone service 97
    - DSL connection 95
    - standard telephone line connection 91
    - VoIP connection 96
  - setting up fax and e-mail functions 304
  - Setup menu 181
  - shipping the printer 231
  - shortcuts, creating
    - copy screen 71
    - e-mail 83
    - fax destination 106
    - FTP address 113
    - FTP destination 112
  - showing icons on the home screen 20
  - sides (duplex)
    - copy options 79
  - Sleep Mode
    - adjusting 197
  - SMTP server not set up. Contact system administrator. 262, 264
  - SMTP Setup menu 138
  - Some held jobs were not restored 262
  - Standard Network menu 131
  - Standard network software error [54] 262
  - standard tray
    - loading 42
  - Standard USB menu 136
  - Standard USB port disabled [56] 262
  - statement of volatility 201
  - status of parts
    - checking 207
  - status of supplies
    - checking 207
  - storing
    - paper 58
    - supplies 210
  - storing print jobs 66
  - streaked horizontal lines appear on prints 288
  - streaked vertical lines appear on prints 290
  - subject and message information
    - adding to e-mail 85
  - Substitute Size menu 124
  - supplies
    - checking status 207
    - checking, on the printer control panel 207
    - checking, using the Embedded Web Server 207
    - conserving 195
    - storing 210
    - using genuine Lexmark 208
    - using recycled paper 195
  - Supplies menu 120
  - supplies, ordering
    - imaging kits 209
    - maintenance kit 210
    - toner cartridges 208
    - waste toner bottle 210
  - Supply needed to complete job 262
  - supply notifications
    - configuring 233
  - supported flash drives 65
  - supported paper types 60
  - supported paper weights 60
- ## T
- TCP/IP menu 133
  - telecommunication notices 321, 322, 323, 324, 325
  - the scanner does not respond 310
  - tips
    - card stock 55
    - labels, paper 54
      - on using envelopes 54
      - on using letterhead 52
    - transparencies 54
  - tips on using envelopes 54
  - tips on using letterhead 52
  - toner cartridges
    - ordering 208
    - recycling 199
    - replacing 222
  - toner darkness
    - adjusting 63
  - Too many flash options installed [58] 262
  - Too many trays attached [58] 263
  - touch screen
    - buttons 17
  - transparencies
    - copying on 70
    - loading 47
    - tips on using 54
  - trays
    - linking 49, 50
    - unlinking 49, 50
  - troubleshooting
    - an application error has occurred 311
    - cannot open Embedded Web Server 311
    - checking an unresponsive printer 264
    - contacting customer support 313
    - FAQ about color printing 294

- fax and e-mail functions are not set up 304
  - solving basic printer problems 264
  - the scanner does not respond 310
  - troubleshooting, color quality
    - color of print and color on computer screen do not match 296
    - print appears tinted 297
    - prints on color transparencies appear dark when projected 296
  - troubleshooting, copy
    - copier does not respond 297
    - partial document or photo copies 297
    - poor copy quality 298
    - poor scanned image quality 308
    - scanner unit does not close 298, 308
  - troubleshooting, display
    - printer display is blank 264
  - troubleshooting, fax
    - caller ID is not shown 300
    - can receive but not send faxes 304
    - can send but not receive faxes 303
    - cannot send or receive a fax 301
    - received fax has poor print quality 305
  - troubleshooting, paper feed
    - message remains after jam is cleared 269
  - troubleshooting, print
    - error reading flash drive 271
    - held jobs do not print 270
    - incorrect characters print 271
    - incorrect margins on prints 280
    - jammed pages are not reprinted 268
    - job prints from wrong tray 272
    - job prints on wrong paper 272
    - jobs do not print 274
    - Large jobs do not collate 272
    - multiple-language PDF files do not print 273
    - paper curl 281
    - paper frequently jams 268
    - print job takes longer than expected 275
    - printing slows down 273
    - tray linking does not work 276
    - unexpected page breaks occur 276
  - troubleshooting, print quality
    - blank pages 285
    - characters have jagged edges 277
    - clipped pages or images 277
    - gray background on prints 278
    - horizontal voids appear on prints 279
    - print irregularities 282
    - print is too dark 283
    - print is too light 284
    - printer is printing solid black pages 286
    - repeating print defects 287
    - shadow images appear on prints 287
    - skewed print 288
    - streaked horizontal lines appear on prints 288
    - streaked vertical lines appear on prints 290
    - toner fog or background shading appears on prints 291
    - toner rubs off 291
    - toner specks appear on prints 292
    - transparency print quality is poor 292
    - uneven print density 292
    - vertical voids appear on prints 293
  - troubleshooting, printer options
    - internal option is not detected 266
    - memory card 267
    - tray problems 267
  - troubleshooting, scan
    - cannot scan from a computer 307
    - partial document or photo scans 309
    - scan job was not successful 307
    - scanner unit does not close 298, 308
    - scanning takes too long or freezes the computer 308
  - Unformatted flash detected [53] 263
  - Universal paper size setting 42
  - Universal Setup menu 129
  - unlinking trays 49, 50
  - Unsupported USB hub, please remove 252
  - USB port 35
  - using a shortcut number
    - scanning to an FTP address 113
  - using Forms and Favorites 62
  - using Hibernate mode 197
  - using Max Speed and Max Yield 63
  - using recycled paper 195
  - using Schedule Power Modes 198
  - using shortcuts
    - sending fax 104
  - using the address book 84
    - sending fax 105
  - using the printer control panel 14
  - using the touch-screen buttons 17
  - Utilities menu 188
- ## V
- verify print jobs 66
    - printing from a Macintosh computer 66
    - printing from Windows 66
  - vertical voids appear on prints 293
  - viewing
    - reports 232
  - viewing a fax log 107
  - virtual display
    - checking, using Embedded Web Server 232
  - voice mail
    - setting up 91
  - Voice over Internet Protocol (VoIP)
    - fax setup 96
  - VoIP adapter 96
  - volatile memory 201
    - erasing 202
  - volatility
    - statement of 201
- ## W
- waste toner bottle
    - ordering 210
    - replacing 211

---

Waste toner bottle nearly full  
[82.xy] 263  
wiping the printer hard disk 203  
Wireless menu 135  
wireless network  
    configuration information 38  
wireless network setup  
    using the Embedded Web  
        Server 40  
wireless setup wizard  
    using 39

## **X**

XPS menu 189