

HUAWEI *Ascend Mate*

User Guide



Contents

Contents	i
Foreword	1
Safety precautions	2
Preparations	3
Your phone at a glance	3
Inserting a Micro-SIM card	4
Inserting a microSD card	5
Charging the battery	6
Powering your phone on and off	7
Setting up your phone for the first time	7
Getting started	8
Gestures	8
Locking and unlocking the screen	8
Getting to know your home screen	9
Hiding the navigation bar	13
Using the notification panel	13
Using one-hand operations	14
Displaying suspend windows	14
Turning on gloves mode	14
Accessing applications	15
Texting	15
Personalizing your phone	19
Setting the theme	19
Changing the wallpaper	19
Setting the home screen transition effect	19
Organizing home screen widgets and application icons	20
Organizing home screen icons using folders	20
Customizing Me Widget	21
Customizing your home screens	22
Customizing switch shortcuts on the notification panel	23
Managing profiles	23
Setting tones	24
Changing the font size	24
Setting the screen unlock method	25
Adjusting the screen brightness	26

Calls	27
Smart dialing	27
Answering or rejecting a call	27
Viewing the call log	28
What you can do during a call	28
Making a conference call	29
Answering a third-party call	29
Making emergency calls	29
Other call services	30
People	32
Creating a contact	32
Searching for a contact	32
Copying contacts	32
Importing or exporting contacts	33
Adding a contact to your favorites	34
Deleting a contact	34
Joining or splitting contacts	34
Sharing contacts	35
Contact groups	35
Messaging	37
Sending a text message	37
Sending a multimedia message	37
Replying to a message	37
Searching for a message	38
Managing messages	38
Modifying message settings	39
Browser	40
Browsing web pages	40
Managing bookmarks	40
Setting the home page	41
Clearing your browsing history	41
Modifying browser settings	41
Email	42
Adding a POP3 or IMAP email account	42
Adding an Exchange account	42
Switching between email accounts	43
Sending emails	43
Checking emails	43

Removing an email account	44
Modifying email account settings	44
Multimedia	45
Camera	45
Gallery	48
Music	50
Internet connection	54
Mobile data connection	54
Setting up a Wi-Fi connection	54
Wi-Fi Direct	55
Sharing your phone's mobile data connection	56
Controlling your data usage	58
Sharing data	60
Bluetooth	60
DLNA	61
Connecting your phone to a computer	61
Connecting your phone to a USB storage device	63
File Manager	65
Creating a folder	65
Searching for a file	65
Copying or cutting a file	65
Compressing or decompressing files	66
Renaming a file	66
Deleting a file	66
Creating a shortcut for a file or folder	66
Checking the memory status	67
Managing applications	68
Downloading applications	68
Installing an application	68
Viewing applications	68
Uninstalling an application	68
Clearing the application cache	69
Backup	70
Backing up data to local storage	70
Restoring data from local storage	70
Google services	71
Gmail	71
Talk	72

Maps	72
YouTube	73
Play Store	74
Basic utilities	75
Calendar	75
Clock	76
Calculator	77
Notes	77
Weather	77
FM radio	79
Accounts and sync	81
Adding an account	81
Deleting an account	81
Turning on data synchronization	81
Modifying account synchronization settings	82
Settings	83
Turning on or off airplane mode	83
Tone settings	83
Display settings	84
Turning on the power manager	84
Setting the date and time	85
Changing the system language	85
Modifying location service settings	85
Setting the PIN of your SIM card	86
Restoring factory settings	86
Online update	87
Accessibility	87
FAQs	88
Legal Notice	90
Index	i

Foreword

Thank you for choosing the **HUAWEI Ascend Mate** smartphone.

This guide introduces you to the features and functions of your new phone. Please read it carefully before you start using the phone.

All pictures and illustrations in this document are for your reference only. The actual product may vary.

Symbols and definitions

The following symbols are used in this document.



Note

Provides additional information.



Caution

Indicates potential problems that may arise without the proper care and, if necessary, how to handle these problems.

Safety precautions

Please read these safety precautions carefully before operating your phone.



Do not crush, throw, or puncture your phone. Avoid dropping, squeezing, or bending it also.



Your phone is not meant for use in a damp environment, such as the bathroom. Do not submerge your phone in liquid of any sort and avoid getting your phone wet.



Avoid using your mobile phone in areas where it may cause interference or present a hazard. Follow local laws and regulations.



Avoid using your phone while driving. Your safety should always be your top priority.



Follow any rules or regulations in hospitals and health care facilities. Power off your phone near any medical apparatus.



Power off your phone in an aircraft. The phone may interfere with the aircraft's control equipment and navigation system.



Power off your phone near high-precision electronic devices. The phone may affect the performance of these devices.



Do not attempt to disassemble your phone or its accessories. Only qualified personnel are allowed to service or repair the phone.



Do not place your phone or its accessories in containers with a strong electromagnetic field.



Do not place magnetic storage media near your phone. Radiation from the phone may erase the information stored on them.



Do not put your phone in a high-temperature place or use it in a place with flammable gas, such as a gas station.



Keep your phone and its accessories away from children. Do not allow young children to use your phone without adult supervision.



Use only approved batteries and chargers to avoid the risk of explosions.



Observe any laws or regulations on the use of wireless devices. Respect the privacy and legal rights of others when using your phone.



To prevent damage to your phone or your computer, follow all instructions pertaining to the USB cable.

Preparations

Your phone at a glance

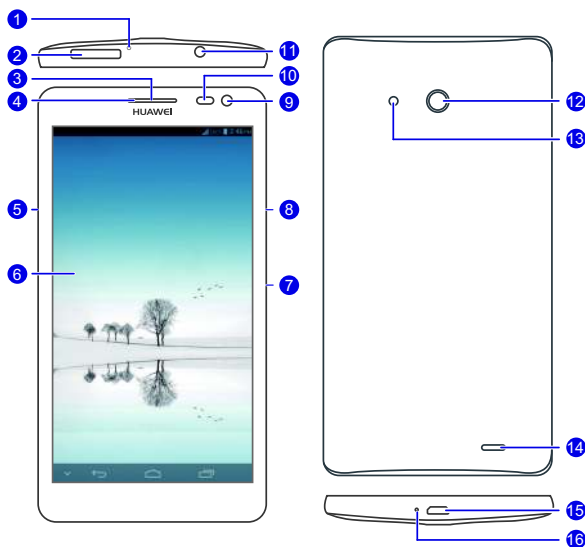

1	Noise reduction microphone	2	Micro-SIM card slot
3	Earpiece	4	Status indicator
5	microSD card slot	6	Screen
7	Volume button	8	Power button 
9	Front camera	10	Proximity sensor/RGB light sensor
11	Headset jack	12	Rear camera

13

Flashlight

14

Speaker

15

Micro USB port



16

Microphone

Buttons

- When your phone is powered off, press and hold  to power it on.



- When the screen is off, press  to turn it on. When the screen is on, press  to turn it off, press and hold  to display an option menu.



Touch  to return to the previous screen or exit the current application.



Touch  to display the list of recently used applications.



Touch  to return to the home screen.

Inserting a Micro-SIM card

-  Your phone supports only micro-SIM cards. Other sizes may not work properly. Contact your service provider to replace or purchase a new card. Power off your phone before installing or removing the micro-SIM card.



The dimensions (L x W) of a standard micro-SIM card is 15 mm x 12 mm (0.59 in. x 0.47 in.). Insert the micro-SIM card as shown in the following figure.

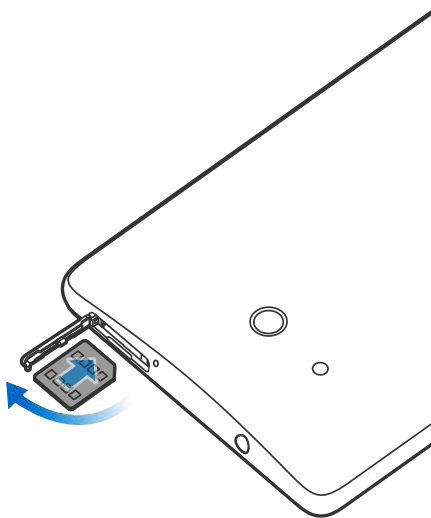

Inserting a microSD card

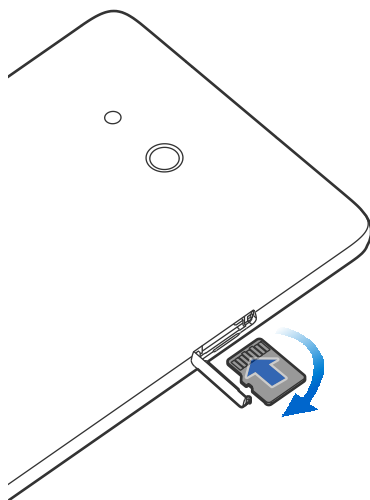

Your Mate supports Class 10 microSD cards. You can expand your phone's storage capacity with a microSD card. Follow the operations in the figure below to install a microSD card.



When installing a microSD card, insert the card fully into the slot until it clicks into place.
To remove a microSD card:

1. On the home screen, touch  then the **All** tab.
2. Under **DEVICE**, touch **Storage**.
3. Touch **Unmount SD card**.
4. Push the microSD card against the slot to make it pop out, and then remove it.

Charging the battery

-  Your phone's built-in battery is not user-removable. To replace the battery, contact an authorized service center. Do not attempt to remove it yourself.
-  Your phone supports fast charging, which requires the provided power adapter and USB cable. Using other power adapters or USB cables may cause repeated restarts, extended charging time, excessive heat, device damage, or in extreme cases, an explosion.

Use the provided USB cable and power adapter to connect your phone to a power outlet, or use the USB cable to connect your phone to a computer.

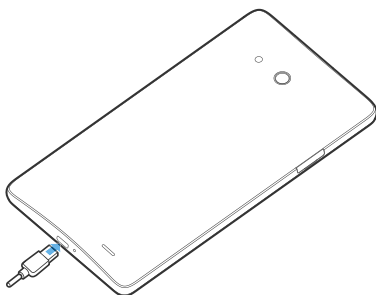

Battery indicator

The battery indicator shows your phone's battery level.





- Blinking red: The battery level is lower than 10%.
- Steady red (when charging): The battery level is lower than 10%.
- Steady yellow (when charging): The battery level is higher than 10%.
- Steady green (when charging): The battery is almost or already full.

Important information about the battery

- If the battery power is depleted, you may not be able to power on your phone immediately after you begin charging the battery. This is normal. Allow the battery to charge for a few minutes before attempting to power on your phone.

- Rechargeable batteries have a limited number of charge cycles and may eventually need to be replaced. When the battery life becomes noticeably shorter, replace the battery.
- The time required to fully charge the battery depends on the ambient temperature and the age of the battery.
- If your phone is very low on power, it plays an alert tone and displays a message. If the battery level is extremely low, your phone automatically powers off.

Powering your phone on and off

- To power on your phone, press and hold .
- To power off your phone, press and hold  to display an option menu, and then touch **Power off**.
-  If errors occur and you cannot power off your phone, press and hold  for 10 or more seconds to restart your phone.

Setting up your phone for the first time

When you use your phone for the first time, follow the onscreen instructions to set it up.

When you power on your phone or open some applications for the first time, your phone walks you through basic operations. To read these instructions again, touch **Management**

>  from the home screen.

Getting started

Gestures

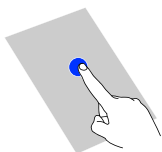

Touch: Tap an item once. For example, touch to select an item or open an application.

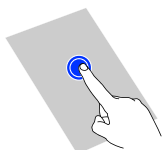

Touch and hold: Touch and leave your finger on the screen for 2 seconds or more. For example, touch and hold an application, widget, or blank area to display the related option menu.

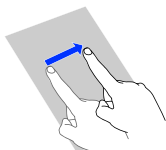

Flick: Where applicable, swipe your finger in the direction you want the screen to move. For example, you can flick left or right across the notification panel to dismiss a notification.

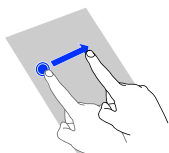

Drag: Touch and hold an item and then move it to another position. For example, you can re-arrange applications and widgets on the home screen this way.

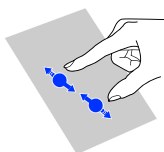



Pinch: Pinch two fingers together to zoom out or stretch them apart to zoom in. For example, pinch together or apart to zoom in or out on a picture or web page.

Locking and unlocking the screen



Locking the screen not only prevents your phone from carrying out undesirable operations when you are not using it, but also protects it from unauthorized use.

You can lock and unlock your screen in a number of ways. The pre-installed screen unlock method is used as an example in this section.

Locking the screen

- Press  to lock the screen.
- After being idle for a specified period of time, your phone automatically locks its screen.
-  To set the screen lock method, touch  on the home screen. On the displayed **General** tab, touch **Screen lock**.

Unlocking the screen

1. If the screen is off, press  to wake it.
2. Drag  down to unlock the screen.

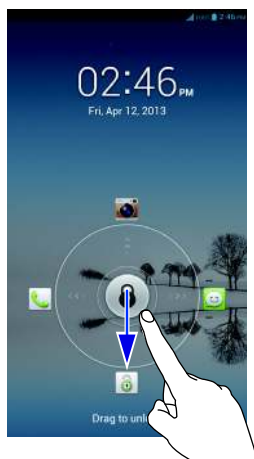

-  Drag  left or right towards an application to open it.

Getting to know your home screen

Your home screens are where you'll find your favorite widgets and all your applications. We did away with the application list to give you a more convenient and direct path to your applications. The default home screen is shown below.



-
- 1 Status bar: displays notifications and icons. Flick down from the status bar to open the notification panel.

 - 2 Display area: displays application icons, folders, and widgets.

































 - 3 Screen position indicator: shows the current screen's position.

 - 4 Dock: displays your most common applications.

 - 5 Navigation bar: displays virtual keys.

Status icons

	Signal strength		No signal
G	GPRS network connected	E	Enhanced Data Rates for GSM Evolution (EDGE) network connected
3G	3G network connected	H	High Speed Downlink Packet Access (HSDPA) network connected

	Roaming		Airplane mode enabled
	Bluetooth on		Receiving location data from GPS
	Vibration mode enabled		Silence mode enabled
	Alarms enabled		Charging
	Battery full		Battery low
	Call in progress		Missed calls
	New messages		New emails
	New voicemail		Select input method
	Wi-Fi network available		Connected to a Wi-Fi network
	Uploading data		Downloading data
	Phone memory full		Upcoming events
	No SIM card found		Sign-in or synchronization problem
	Synchronizing data		Synchronization failed
	Portable Wi-Fi hotspot on		More notifications
	Connected to a VPN		Headset plugged in
	Connected to a computer		USB tethering on

Switching between home screens

Running out of space on the home screen? Not to worry. Your phone lets you create more home screens for various application icons and widgets.

- Flick left and right across the screen to switch between the home screens.



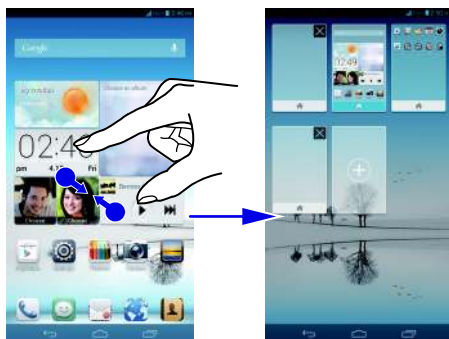

- Pinch two fingers together to display the home screen thumbnails. Touch a thumbnail to enter that particular home screen.



Taking a screenshot

Want to share an interesting scene in a movie or show off your new high score in a game? Take a screenshot and share away.

Press  and the volume down button simultaneously to take a screenshot. Then, open the notification panel and touch  to share the screenshot. Screenshots are saved to the **Screenshots** album in **Gallery**.

Auto-rotate screen

Your phone features a tilt sensor. If you rotate your phone when browsing a web page or viewing a photo, the orientation of your screen will automatically change to landscape or portrait view. You'll also be able to enjoy tilt sensor-based applications, such as some downloaded racing games.

To quickly turn the auto-rotate screen function on or off, flick down from the status bar to open the notification panel and touch .

If the auto-rotate screen function is turned on and your screen is in landscape view, you can flick left from the right of the screen to display the navigation bar.

Hiding the navigation bar

1. On the home screen, touch  then the **All** tab.
2. Under **DEVICE**, touch **Navigation bar**.
3. Touch **Hide navigation bar**.

After the function is turned on, you can touch  to hide the navigation bar. To display it again, flick up from the bottom of the screen.

Using the notification panel

Flick down from the status bar to open the notification panel.

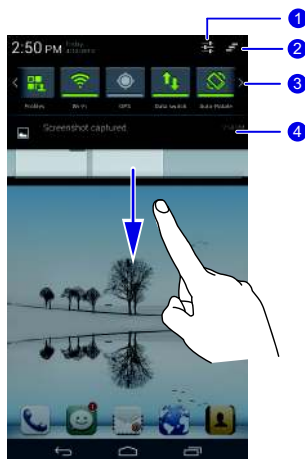

1 Touch  to display the settings screen.

2 Touch  to delete all notifications.

-
- 3 Touch the switch shortcuts on the notification panel to turn functions on or off.
-
- 4 Touch an application to start it and flick left or right across a notification to dismiss it.
-

Using one-hand operations



Turn on one-hand operations to operate the large screen with ease using just one hand.



1. On the home screen, touch  then the **All** tab.
2. Touch **One-hand operations**.
3. Select where you wish to apply one-hand operations.

With **One-hand operations** enabled, use the arrow on either side of the screen to move the screen lock, dialer, or other object to the left or right.

Displaying suspend windows

Suspend windows let you operate multiple applications on the same screen.

1. On the home screen, touch  then the **All** tab.
2. Turn on **Suspend button**.
3. Touch  to bring up the suspend windows screen. Here, you can open preset applications on your phone or move some of them around.

-  With **Suspend button** enabled, the suspend button  will be displayed in most screens. To disable it, turn off **Suspend button**.

Turning on gloves mode

Gloves mode lets you perform touchscreen operations even while wearing gloves.

1. On the home screen, touch  then the **All** tab.
2. Touch the **Gloves mode** switch to enable gloves mode.

Accessing applications

Starting applications and switching between them

On the home screen, touch an application icon to open it.

To switch to another application, touch  to return to the home screen, and touch the icon of the application you wish to open.

Viewing recently used applications

To display the list of recently used applications, touch . You can then:

- Touch an application to start it.
- Flick left or right across an application to dismiss it.
- Touch  to clear the list.



Texting

Your phone comes with multiple text input methods. You can quickly enter text using the onscreen keyboard.

- Touch a text box to bring up the onscreen keyboard.
- To hide the onscreen keyboard, touch .

Selecting an input method





1. On the text input screen, flick down from the status bar to open the notification panel.
2. Touch  to select an input method.

-  To change your phone's default input method, touch  on the home screen. Then touch the **All** tab. Under **PERSONAL**, touch **Language & input** > **Default** to select an input method.

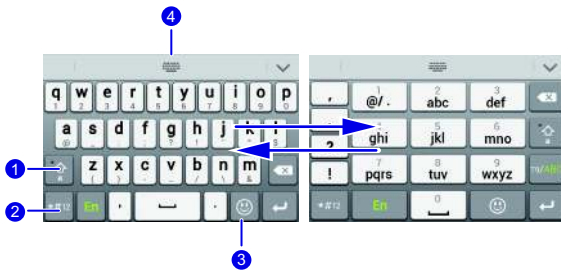
Huawei input method



Slide your finger left or right across the onscreen keyboard to switch between the QWERTY and 9-key keyboards.











-
- 1 Touch  to switch between lowercase letters, uppercase letters, and caps lock.
-
- 2 Touch  to enter numbers and symbols.
-
- 3 Touch  to enter emoticons.
-
- 4 Touch  to switch between QWERTY, 9-key, and other input modes.
-

Android input method







-
- 1
 - Touch  to switch between lowercase and uppercase letters.
 - Quickly touch  twice to turn on caps lock.
-
- 2 Touch  to enter numbers and symbols.
-

-
- 3 • Touch  to switch to voice input.
 - Touch and hold  to open the **Input options** menu.
-
- 4 • Touch  to enter a space.
 - Touch and hold  to choose another input method.
-
- 5 • Touch  to enter a period.
 - Touch and hold  to enter symbols.
-
- 6 • Touch  to delete the character to the left of the cursor.
 - Touch and hold  to delete all characters to the left of the cursor.
-

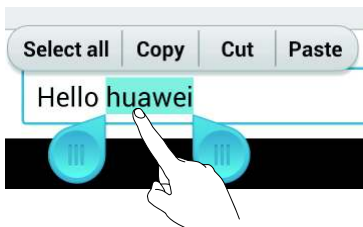
Editing text

Learn how to select, cut, copy, and paste text on your phone.



- **Select text:** Touch and hold the text to bring up . Then drag  and  to select more or less text, or touch **Select all** to select all text in a text box.
- **Cut text:** Select text and touch **Cut**.
- **Copy text:** Select text and touch **Copy**.
- **Paste text:** Touch where you want to insert the text, drag  to move the insertion point, and touch **Paste** to paste the text you copied or cut.



Configuring an input method

1. On the home screen, touch  then the **All** tab.
2. Under **PERSONAL**, touch **Language & input**.
3. Under **Keyboard & input methods**, touch the input method you wish to configure.

Personalizing your phone

Setting the theme

Your phone comes with a variety of themes. You can download more themes and mix and match theme elements to find a perfect fit.

Changing the theme

1. On the home screen, touch .
2. Select a theme and touch **APPLY** to apply it.

Customizing a theme

1. From the theme grid, touch **CUSTOMIZE CURRENT THEME**.
2. From the element list, choose the element you wish to modify.
3. When you are done, touch **SAVE AS MY THEME** on the **Customize** screen.

The customized theme is then saved to the **Local** tab.

Changing the wallpaper

1. On the home screen, touch and hold a blank area to display the **Set home screen** dialog box.
2. Touch **Wallpapers**.
3. From the **Wallpapers** screen, you can set the following items:
 - **Lock screen wallpaper**: Set the wallpaper displayed on the phone lock screen.
 - **Home screen wallpaper**: Set the home screen wallpaper.
 - **Shake to change**: Change the home screen wallpaper by shaking your phone.
 - **Random change**: The home screen wallpaper changes randomly.

Setting the home screen transition effect

1. On the home screen, touch and hold a blank area to display the **Set home screen** dialog box.

2. Touch **Transitions**.
3. Select a home screen transition effect.



Organizing home screen widgets and application icons

Adding a widget to the home screen

1. On the home screen, touch and hold a blank area to display the **Set home screen** dialog box.
2. Touch **Widgets**.
3. Drag a widget from the screen's lower section to a screen thumbnail.
4. Touch  to return to the home screen.

 If the home screen doesn't have enough space, your phone will automatically create a new home screen to the original's right and place the widget on the new home screen.

Deleting an application icon or widget

On the home screen, touch and hold the application icon or widget you wish to delete until  is displayed. Drag the unwanted application icon or widget to  to delete it.

 Deleting an application icon uninstalls the application. When you delete an application icon, your phone prompts you to confirm the action. Touch **OK** to uninstall the application.

Moving an application icon or widget

You can re-arrange application icons and widgets to any fitting empty space on the home screen.

Organizing home screen icons using folders

Creating a folder on the home screen

1. On the home screen, drag an item onto another one to create a folder containing both of them.
2. You can then:
 - Touch the folder name to rename it.

- Touch **+** and add more items to the folder.

Removing an item from a folder

1. On the home screen, touch a folder.
2. Drag an item out from the folder to remove the item.





A folder must contain at least two items; otherwise, the folder will automatically disappear.

Customizing Me Widget



Me Widget is a collage of popular widget units that is displayed on your home screen for your added convenience. They include contacts, music, clock, and weather.





Removing a widget unit

1. Touch and hold Me Widget until your phone vibrates. Release your finger. The  icon is displayed in the upper right corner.
2. Touch  to enter editing mode.
3. Touch  for the widget unit you wish to remove.
4. When you are done, touch .



Adding a widget unit

1. Touch and hold Me Widget until your phone vibrates. Release your finger. The  icon is displayed in the upper right corner.
2. Touch  to enter editing mode.

3. Flick left or right across the widget unit list, select a widget unit and drag it to a blank area on Me Widget.
 -  Me Widget's size cannot be adjusted, so space is limited. If there is not enough space for a new widget unit, delete some existing ones first.
4. When you are done, touch  .

Moving a widget unit

Before you move a widget unit, make sure there is enough space to hold it in the new position.

1. Touch and hold Me Widget until your phone vibrates. Release your finger. The  icon is displayed in the upper right corner.
2. Touch  to enter editing mode.
3. Touch and hold a widget unit until your phone vibrates, and drag it to the new position.
4. When you are done, touch  .

Customizing your home screens

Re-arranging home screens

1. On a home screen, touch and hold a blank area to display the **Set home screen** dialog box.
2. Touch **Thumbnails**.
3. Touch and hold a home screen thumbnail until your phone vibrates, and drag it to the new location.

Adding a home screen

1. On a home screen, touch and hold a blank area to display the **Set home screen** dialog box.
2. Touch **Thumbnails**.
3. Touch  to add a home screen.

Deleting a home screen

Only blank home screens can be deleted.

1. On a home screen, touch and hold a blank area to display the **Set home screen** dialog box.
2. Touch **Thumbnails**.
3. Touch  to delete a home screen.



Customizing switch shortcuts on the notification panel

You can rearrange your switch shortcuts and move those you use most to top the list. Shortcuts on the top will be fully displayed on the notification panel.



1. Flick down from the status bar to open the notification panel.
2. Flick left on the upper area. Touch  to display the switch shortcut list.
3. Drag a switch shortcut to a new position in the list.

Managing profiles

Changing the profile



1. On the home screen, touch .
 2. From the profile list, select a profile and touch the button to its right to activate the profile.
-  You can also flick down from the status bar to open the notification panel and change the profile using the switch shortcuts.

Adding a profile

1. On the home screen, touch .
2. Touch .
3. Touch the text box and name the profile.
4. Touch **Next**.
5. Select actions for the profile and touch an action to configure its settings.
6. When you are done, touch **Done**.

Deleting a profile

To delete a custom profile, perform the following operations:

1. On the home screen, touch .
2. Touch  > **Delete**.
3. Select the profiles you wish to delete.
4. Touch **DELETE**.
5. Touch **OK**.

 Preset profiles cannot be deleted.

Setting tones

Setting the ringtone

1. On the home screen, touch  then the **All** tab.
2. Under **DEVICE**, touch **Sound**.
3. Touch **Phone ringtone** and select either of the following options from the displayed dialog box:
 - **Ringtone**: choose from the default selection.
 - **Local music**: choose from the audio files you have saved to your phone.
4. Touch **OK**.

Changing message tone and other tones

1. On the home screen, touch  then the **All** tab.
2. Under **DEVICE**, touch **Sound**.
3. Touch **Notification tone**.
4. Select a tone type.

 You can configure the email notification tone only after you have set up an email account.
5. Select a tone.
6. Touch **OK**.

Changing the font size

1. On the home screen, touch  then the **All** tab.

2. Under **DEVICE**, touch **Display**.
3. Touch **Font size** and select a font size.

Setting the screen unlock method

Face unlock



Enable your data service before using face unlock for the first time.

1. On the home screen, touch  then the **All** tab.
2. Under **PERSONAL**, touch **Security**.
3. Touch **Screen lock > Face Unlock**.
4. Follow the onscreen instructions to take a photo of your face.
Your phone will use face unlock as the primary unlock method.
5. Set a secondary unlock method.

If face unlock cannot recognize you (dim light, for example), follow the onscreen instructions to unlock your phone using the secondary unlock method.

To turn off face unlock, use the secondary unlock method to enter the **Screen lock** screen, and select another unlock method.

Unlocking the screen with a pattern

1. On the home screen, touch  then the **All** tab.
2. Under **PERSONAL**, touch **Security**.
3. Touch **Screen lock > Pattern**.
4. Follow the onscreen instructions to set a screen unlock pattern.
 If you draw incorrect patterns five consecutive times, the screen stops responding to further unlock attempts for 30 seconds. You will still be able to make emergency calls during this time.

Unlocking the screen with a PIN

1. On the home screen, touch  then the **All** tab.
2. Under **PERSONAL**, touch **Security**.
3. Touch **Screen lock > PIN**.
4. Follow the onscreen instructions to set a screen unlock PIN.

After a screen unlock PIN is set, you will have to enter it every time you want to unlock the phone screen.

Unlocking the screen with a password

1. On the home screen, touch  then the **All** tab.
2. Under **PERSONAL**, touch **Security**.
3. Touch **Screen lock > Password**.
4. Follow the onscreen instructions to set a screen unlock password.
5. Repeat the password and touch **OK**.

After a password is set, you will have to enter it every time you want to unlock the phone screen.

-  If you enter incorrect passwords five consecutive times, the screen stops responding to further unlock attempts for 30 seconds. You will still be able to make emergency calls during this time.

Adjusting the screen brightness



1. On the home screen, touch  then the **All** tab.
2. Under **DEVICE**, touch **Display**.
3. Touch **Brightness**.
4. In the displayed dialog box, perform either of the following operations:
 - Select the **Automatic brightness** check box to have your phone automatically adjust its screen brightness based on the ambient light.
 - Drag the slider left to reduce the screen brightness or drag it right to increase the screen brightness.

You can also flick down from the status bar to open the notification panel and adjust the screen brightness using the switch shortcuts.

Calls

Smart dialing





In addition to standard call procedures, smart dialing lets you quickly find contacts by entering parts of their names or numbers.

1. On the home screen, touch .
2. Enter a phone number or the initials or first several letters of a contact name.
Matching contacts in your phone and phone numbers in your call log are then displayed in a list.
3. From the list, select the contact you wish to call.
4. To end the call, touch .

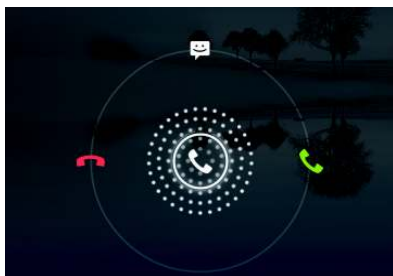

Answering or rejecting a call

-  When a call comes in, you can press the volume button to mute the ringtone.











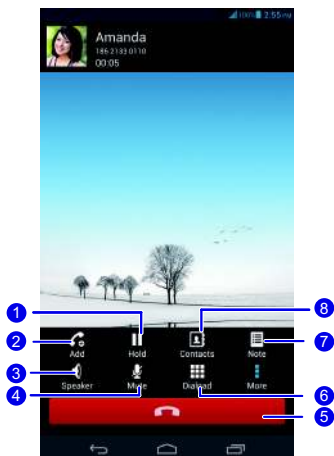

- Drag  right to answer the call.
- Drag  left to reject the call.
- Drag  up to reject the call and send the caller a message.
-  On the dialer screen, touch  > **Settings** > **Quick responses** to edit the message that will be sent.

Viewing the call log

1. On the home screen, touch  to display your recent calls above the dialer.
2. Touch  > **Missed calls** to view your missed calls.

What you can do during a call



- 1 Touch  >  to place the current call on hold, and touch  again to resume the call.
- 2 Touch  >  to start a three-way call. Before you use three-way calling, make sure that you have subscribed to this service. For details, contact your service provider.
- 3 Touch  to use the speakerphone.
- 4 Touch  to mute or unmute the microphone.
- 5 Touch  to end the call.
- 6 Touch  to display the dialer.

7 Touch  >  to display a note.





8 Touch  >  to display the contact list.

To return to the call screen, flick down from the status bar to open the notification panel, and touch **Current call**.

Making a conference call



Conference calling with your friends, family, and co-workers is easy. Make or answer a call, and dial another number to add the second participant to your conference call.

 Before you make a conference call, make sure that you have subscribed to the conference call service. For details, contact your service provider.

1. Call the first participant.
2. When the call is connected, touch  >  to call the second participant. The first participant will be placed on hold.
3. When the second call is connected, touch  to start a conference call.
4. To add more people to the call, repeat steps 2 and 3.
5. Touch  to end the call.

Answering a third-party call

Before you answer a third-party call, make sure that you have turned on call waiting.

1. If a call comes in when you are already busy on the phone, drag  right to answer the new call and place the first call on hold.
2. To switch between the two calls, touch .

Making emergency calls

In the event of an emergency, you will still be able to make emergency calls without the use of a SIM card. However, you must still be under the coverage area.

1. On the home screen, touch .

2. Enter your local emergency number and touch .

 Emergency calls are subject to cellular network quality, use environment, service provider policies, and local laws and regulations. Never rely solely on your phone for critical communications when emergencies occur.

Other call services

Your phone also supports other call functions, such as call forwarding, call waiting, and voicemail. Before you use these functions, make sure that you have subscribed to these services. For details, contact your service provider.

Enabling call forwarding

Too busy to answer all your calls with one phone? Forward them to another number and never miss an important call again!

1. On the home screen, touch  then the **All** tab.
2. Under **APPS**, touch **Call**.
3. Touch **Call forwarding**.
4. Select a forwarding mode.
5. Enter the phone number to which you wish to forward calls, and touch **Enable**.

Enabling call waiting

The call waiting function lets you answer another incoming call when you are already busy in a call and switch between the two calls.

1. On the home screen, touch  then the **All** tab.
2. Under **APPS**, touch **Call**.
3. Touch **Additional settings**.
4. Touch **Call waiting** to enable call waiting.

Setting up your voicemail

Voicemail is your personal storage for missed calls, including the calls missed when you are busy on the phone or your phone is powered off.

-  Before you use voicemail, make sure you have subscribed to the voicemail service and obtained your voicemail number. For details, contact your service provider. You must also enable call forwarding and set all incoming calls to be forwarded to your voicemail.



1. On the home screen, touch  then the **All** tab.
2. Under **APPS**, touch **Call**.
3. Touch **Voicemail > Voicemail settings > Voicemail number**.
4. Enter your voicemail number, and touch **OK**.

To listen to your voicemail messages, touch and hold the **1** key on the dialer and follow the voice instructions.

People

Forget about lugging around business card holders. With your phone, you can easily store and manage your contacts in your new phone.

Creating a contact

1. On the home screen, touch  then the **Contacts** tab.
2. Touch .
3. Select an account you wish to use.
4. Enter the contact name, phone number, and more. Touch **Add another field** to enter more entries.
5. Touch **DONE** to save the contact.



Searching for a contact

1. On the home screen, touch  then the **Contacts** tab.
2. Touch the search box.
3. Enter the contact name or initials.

Matching results are displayed as you type.

For example, to search for John Doe, enter **John Doe** or **J D**.

Copying contacts



1. On the home screen, touch  then the **Contacts** tab.
2. Touch  > **More** > **Manage contacts** > **Copy contacts**.
3. From the displayed option menu, select where the contacts you wish to copy are from.
4. Touch the contact you wish to copy or touch **Select all** to select all contacts.
5. Touch **Copy** and select the account to which you wish to copy the contacts.

Importing or exporting contacts

Your phone supports contact files in .vcf format only. This is a standard format for files storing contacts. Contact names, addresses, phone numbers, and other information can be saved in .vcf files.

Importing contacts from a storage device



You can import contacts saved in a .vcf file from a storage device to your phone.

1. On the home screen, touch  then the **Contacts** tab.
2. Touch  > **More** > **Manage contacts** > **Import from storage**.
3. Select one or more .vcf file.
4. Touch **OK**.

Importing contacts from a Bluetooth device



You can import contacts saved in a .vcf file from a Bluetooth device to your phone.

Before you import contacts, enable Bluetooth on your phone.

1. On the home screen, touch  then the **Contacts** tab.
2. Touch  > **More** > **Manage contacts** > **Import via Bluetooth**.
Your phone then searches for available Bluetooth devices.
3. Touch the Bluetooth device with which you wish to pair your phone.
When the two devices are paired, your phone automatically imports the .vcf file from the other device.



Exporting contacts

Back up your contacts to a storage device in case you lose them during a system upgrade or by mistake.



1. On the home screen, touch  then the **Contacts** tab.
2. Touch  > **More** > **Manage contacts** > **Export to storage**.
A dialog box is then displayed, indicating the exported .vcf file name and its save location.
3. Touch **OK**.

To view the .vcf file you just exported, open the **File Manager** application. The file is displayed in the root directory of your phone's internal storage.

Adding a contact to your favorites

1. On the home screen, touch  then the **Favorites** tab.
2. Touch .
3. Touch the contact you wish to add to favorites or touch **Select all** to select all contacts.
4. Touch **Add**.

Deleting a contact

1. On the home screen, touch  then the **Contacts** tab.
2. Touch  > **Delete contacts**.
3. Touch the contact you wish to delete or touch **Select all** to select all contacts.
4. Touch **Delete**.
5. Touch **OK**.

Joining or splitting contacts

Annoyed when you have multiple entries for the same contact from different accounts? Join these entries to better manage your contacts.

 Contacts stored in the SIM card cannot be joined or split.

Joining contacts

1. On the home screen, touch  then the **Contacts** tab.
2. Select the main contact you want the other contacts to be joined to.
3. Touch **Manage joined contacts** > **Add contact**.
4. Select the contacts to be joined.

After you join the contacts, they are all saved to the main contact.

Splitting contacts



Joined the wrong contacts by mistake? Not to worry, it's not too late to reverse course.

1. On the home screen, touch  then the **Contacts** tab.

2. Select the contact you wish to split.
3. Touch **Manage joined contacts** to display the **Joined contacts** screen.
4. Touch  to the right of the contact to split it.

Sharing contacts



You can share contacts in .vcf format in many ways.

1. On the home screen, touch  then the **Contacts** tab.
2. Touch  > **Share contacts**.
3. Touch the contact you wish to share or touch **Select all** to select all contacts.
4. Touch **Share** and choose a sharing method from the displayed option menu.

Contact groups

You can create a contact group and send a message or email to all group members simultaneously.





Creating a contact group

1. On the home screen, touch  then the **Groups** tab.
2. Touch .
3. Name the contact group.
4. Touch **Add members**.
5. Select one or more contacts.
6. Touch **Add members**.
7. Touch **DONE**.



Editing a contact group

1. On the home screen, touch  then the **Groups** tab.
2. Touch and hold the contact group you wish to edit.
3. From the displayed option menu, choose **Edit**.
4. Rename the group or manage group members.
5. Touch **DONE**.

Sending messages or emails to a contact group





1. On the home screen, touch  then the **Groups** tab.
 2. Touch and hold the contact group you wish to send a message or email to.
 3. From the displayed option menu, choose **Send message** or **Send Mail**.
-  You can also open the contact group and touch  to send a message or  to send an email.

Deleting a contact group

1. On the home screen, touch  then the **Groups** tab.
 2. Touch and hold the contact group you wish to delete.
 3. From the displayed option menu, choose **Delete**.
-  Deleting a contact group will not remove the contacts in the group from your phone.









Messaging

Sending a text message

1. On the home screen, touch .
2. In the list of message threads, touch .
3. Touch the recipient text box and enter the contact name or phone number.
 -  Touch  to select more contacts.
4. Write your message.
5. When you are done, touch .

Sending a multimedia message

Make sure your data service is on before you try to send multimedia messages.



1. On the home screen, touch .
2. In the list of message threads, touch .
3. Touch the recipient text box and enter the contact name or phone number.
 -  Touch  to select more contacts.
4. Touch  > **Add subject** and enter the message subject.
5. Write your message.
6. Touch , select the attachment type, and attach a file.
 -  To attach more than one file to the message, touch **Slideshow**.
7. When you are done, touch .

Replying to a message

1. On the home screen, touch .
2. In the list of message threads, touch a contact name or phone number to view the conversation thread.

3. Touch the text field to write your reply.
4. When you are done, touch .

Searching for a message





1. On the home screen, touch .
2. In the list of message threads, touch .
3. Enter the message or contact, or parts of them.
Your phone then displays matching results.

Managing messages

Copying a message

1. On the home screen, touch .
2. In the list of message threads, touch a contact name or phone number to view the conversation thread.
3. Touch and hold the message you wish to copy.
4. From the displayed option menu, choose **Copy text**.
5. Touch and hold the area you wish to paste the message and touch **Paste**.

Forwarding a message



1. On the home screen, touch .
2. In the list of message threads, touch a contact name or phone number to view the conversation thread.
3. Touch and hold the message you wish to forward.
4. From the displayed option menu, choose **Forward**.
5. Touch the recipient text box and enter the contact name or phone number.
 Touch  to select more contacts.
6. When you are done, touch .

Locking a message

You can lock important messages to avoid deleting them by mistake. Deleting a thread does not remove the locked messages in it.

1. On the home screen, touch .
2. In the list of message threads, touch a contact name or phone number to view the conversation thread.
3. Touch and hold the message you wish to lock.
4. From the displayed option menu, choose **Lock**.



Deleting a message

1. On the home screen, touch .
2. In the list of message threads, touch a contact name or phone number to view the conversation thread.
3. When you are done, touch  > **More** > **Delete**.
4. Select the messages you wish to delete.
5. Touch **Delete**.
6. Touch **Delete**.

Deleting a thread

1. On the home screen, touch .
2. In the list of message threads, touch and hold the thread you wish to delete.
3. From the displayed option menu, choose **Delete messages**.
4. Touch **Delete**.

Modifying message settings

1. On the home screen, touch .
2. In the list of message threads, touch .
3. Touch **Settings**.
4. Change the message tone, manage SIM card messages, and more.

Browser

Your phone's browser lets you surf the web and stay on the ball with up-to-date news and information. Staying connected has never been easier.



Browsing web pages

1. On the home screen, touch  .
2. Enter a website address in the address box.
Your phone displays matching websites as you type.
3. Touch the website you wish to visit.



Managing bookmarks

Bookmarks let you keep track of your favorite websites.



Adding a bookmark

1. On the home screen, touch  .
2. On the **Browser** screen, open the web page you wish to add as a bookmark.
3. Touch  > **Save to bookmarks**.
4. Name the bookmark or use the default name. Then, touch **OK**.

Accessing a bookmark

1. On the home screen, touch  .
2. On the **Browser** screen, touch  .
3. Touch **Bookmarks**.
4. Under **Local**, touch a bookmark.



Editing a bookmark

1. On the home screen, touch  .
2. On the **Browser** screen, touch  .
3. Touch **Bookmarks**.

4. Touch and hold the bookmark you wish to edit.
5. From the displayed option menu, choose **Edit bookmark**.
6. Edit the bookmark, for example, rename it.
7. Touch **OK**.



Setting the home page

Set your favorite web page as your browser's home page to make life a little easier.



1. On the home screen, touch .
2. On the **Browser** screen, touch .
3. Touch **Settings > General > Set homepage**.
4. From the displayed option menu, choose the web page you wish to set as the home page.

Clearing your browsing history

To better protect your privacy, clear your browsing history from time to time.

1. On the home screen, touch .
2. On the **Browser** screen, touch .
3. Touch **Settings > Privacy & security > Clear history**.
4. Touch **OK**.

Modifying browser settings

1. On the home screen, touch .
2. On the **Browser** screen, touch .
3. Touch **Settings**.
4. Customize your browser settings to better fit your needs.

Email



Don't want to miss important emails from your friends or clients during your business trip? Use your phone to read and reply to emails when you are on the go.

Adding a POP3 or IMAP email account

Certain parameters must be set when you add a POP3 or IMAP email account. For details, contact your email service provider.

1. On the home screen, touch .
2. Select an email account type.
3. Enter your **Email address** and **Password**, and touch **Next**.
4. Follow the onscreen instructions to configure the email settings.

When the email account is set up, the **Inbox** screen is displayed.

 To add more email accounts, touch  > **Settings** > **Add account**.

Adding an Exchange account

Exchange is an email system developed by Microsoft to implement communication inside an enterprise. Some email service providers also provide Exchange accounts for individuals and families.

Certain parameters must be set when you add an Exchange account. For details, contact your email service provider.



1. On the home screen, touch .
2. Touch **Exchange**.
3. Enter your **Email address**, **Domain**, **Username**, and **Password**. Then, touch **Next**.
4. Follow the onscreen instructions to configure the email settings.

When the Exchange account is set up, the **Inbox** screen is displayed.









Switching between email accounts

1. On the home screen, touch .
2. Touch the email address on the top to display your email account list.
3. Touch an email account you wish to use.

Sending emails



1. On the home screen, touch .
2. Open an email account.
3. On the **Inbox** screen, touch .
4. Enter the recipient and subject and write your message. Upload any attachments.
5. When you are done, touch  to send the email.

Checking emails



1. On the home screen, touch .
 2. Open an email account.
 3. On the **Inbox** screen, touch the email you wish to read.
 4. When reading an email, you can:
 - Touch  to reply to it.
 - Touch  to forward it.
 - Touch  to delete it.
 - Touch  to mark it as unread.
 - Touch  to read the previous email.
 - Touch  to read the next email.
-  Mail retrieval may be slightly delayed depending on the network condition.
- Touch  in the lower right corner to refresh the inbox.

Removing an email account

After you delete an email account, your phone will no longer send or receive emails using that account.

1. On the home screen, touch  .
2. On the **Inbox** screen, touch  .
3. Touch **Settings**.
4. Select the account you wish to delete.
5. Under **Remove account**, touch **Remove account**.
6. Touch **OK**.

Modifying email account settings

1. On the home screen, touch  .
2. On the **Inbox** screen, touch  .
3. Touch **Settings** > **General**.
4. Set the font size, display options, and other settings.

Multimedia



Camera

As time flies by, there must be some memories you wish to keep forever. Camera is a great tool for this. It supports a variety of capture modes, such as group, panoramic, and smile.

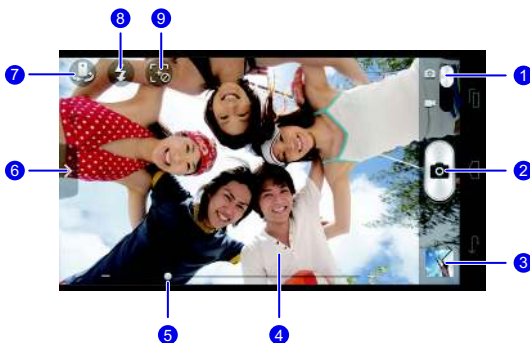

Photo taking screen



1

- Drag the slider to  to switch to photo mode.
- Drag the slider to  to switch to video mode.

2

- Touch  to take a photo.
- Touch and hold  to focus the camera. Then, release your finger to take a photo.

3

- Touch the thumbnail to view photos you just took.





4

- Touch an object on the viewfinder to focus the camera on it.

5

- Drag the slider to zoom in or out.

Drag  to display an option menu, from which you can:



- Touch  to select a capture mode.
- 6 • Touch  to select a filter.
- Touch  to select a special effect.
- Touch  to set the capture scenario, white balance, ISO, and more.

7 Touch  to switch between the rear and front cameras.



8 Touch  to set the flashlight mode.

9 Touch  to enable the tracking function. You can then touch an object you wish to focus on. The camera will track and focus on that object.

Taking a photo

1. On the home screen, touch .
2. Frame the scene you wish to capture.
3. Touch and hold  until the viewfinder frame turns green, indicating that the camera is now focused.
4. Release your finger to take the photo.





Shooting a video

1. On the home screen, touch .
2. Frame the scene you wish to record.
3. Touch  to start recording.
4. Touch  to stop recording.

Taking a panoramic photo

Are you still upset that your camera's view angle isn't wide enough to capture an incredible scene? Panorama mode is exactly the solution you need. You'll be able to piece together several photos and combine them into one seamless shot.



1. On the home screen, touch .



2. Drag  to open the settings menu. Then, touch  > **Panorama**.
3. Frame the scene you wish to capture.
4. Tap .
5. Move your phone slowly to capture the view along the direction indicated by the arrow and allow the phone to capture multiple photos.
 -  If the viewfinder screen turns red, the view will not be captured. This may happen because you have moved your phone too fast or the viewfinder scope exceeds the limit of the panoramic view.
6. Your phone stops shooting when it has taken enough photos for a panoramic photo. You can also touch  to stop shooting.

The camera automatically stitches the photos together to create one panoramic photograph.

Taking a group picture

When you travel with your family, hang out with friends, or attend a party, everyone wants to put up their best face for that inevitable group photo. But when someone sneezes or blinks, that photo may not turn out to be the one that shows everyone in their best form. This will no longer be an issue with group shooting. In this mode, multiple photos will be taken over the course of a few seconds. So if the initial shot captured your face at a untimely moment, simply switch it out for one that captured your best smile!



1. On the home screen, touch .
 2. Drag  to open the settings menu. Then, touch  > **Group**.
 3. Frame the scene you wish to capture.

The camera will identify the faces and automatically focus on them.
 4. Touch .
 5. Select your favorite faces for everyone.
 6. Tap .
- Your phone then updates any face changes and saves the photo.

Taking a beauty-mode photo





Expect great photo quality when you don't have any makeup? Enable beauty mode for a flawless portrait of yourself.

1. On the home screen, touch .

2. Drag  to open the settings menu. Then, touch  > **Beauty**.
3. Frame the scene you wish to capture.
The camera will identify a face and automatically focus on it.
4. Tap .

Using HDR

High dynamic range (HDR) imaging technology improves the details in the lightest and darkest areas of photos to present more life-like qualities.



1. On the home screen, touch .
2. Drag  to open the settings menu. Then, touch  > **HDR**.
3. Frame the scene you wish to capture.
4. Touch and hold  until the viewfinder frame turns green, indicating that the camera is now focused.
5. Release your finger to take the photo.

Gallery



Gallery is your personal treasure box of sweet memories.

Viewing photos or videos

In your **Gallery**, photos and videos are stored in separate albums.





1. On the home screen, touch .
 2. Touch the album you wish to view.
 3. Touch the photo or video to view it in full screen mode.
-  When viewing a photo, pinch two fingers together to zoom out or spread them apart to zoom in.

Playing a slideshow



1. On the home screen, touch .
2. Touch an album.
3. Touch  to play photos in the album as a slideshow.
4. Touch the screen to stop the slideshow.

Editing a photo



You can remove red eye, crop a photo, or apply a number of effects to make your photos even more stunning.

1. On the home screen, touch .
2. Touch the photo you wish to edit.
3. Touch  > **Edit** and then you can:
 - Touch  to lighten or shadow the photo.
 - Touch **FX** to cross-process or posterize the photo.
 - Touch  to tint the photo or make it negative.
 - Touch  to rotate or crop the photo.
4. Touch **SAVE**.

Rotating a photo

1. On the home screen, touch .
2. Touch the photo you wish to rotate.
3. Touch  > **Rotate Left** or **Rotate Right**.
 -  You can also enable the auto-rotate screen function to have your phone automatically adjust the display orientation when you rotate your phone.

Cropping a photo

1. On the home screen, touch .
2. Touch the photo you wish to crop.
3. Touch  > **Crop** and then you can:
 - Drag the grid to reposition it.
 - Drag the frames of the grid to resize it.
4. Touch **SAVE**.



Deleting a photo

1. On the home screen, touch .
2. Touch the photo you wish to delete.



3. Touch  .
4. Touch **OK**.

Sharing a photo or video

Want to share your best shots or an amusing trick your dog just did? Simply share the photos and videos using email, Bluetooth, and more.

1. On the home screen, touch  .
2. Touch the photo or video you wish to share.
3. Touch  .
4. Choose a sharing method and follow the onscreen instructions.

Setting a photo as the wallpaper

1. On the home screen, touch  .
2. Choose the photo you wish to set as the wallpaper.
3. Touch  > **Set picture as** > **Wallpaper**.
4. Drag the frames of the grid to resize it.
5. Touch **SAVE**.

Music

In the mood for music? Your phone provides you with a supreme audio experience.

Adding songs

You can copy songs to your phone and immerse yourself with extraordinary audio experience anytime. Add songs to your phone by:

- Copying songs from your computer using USB.
- Downloading songs from the web.
- Copying songs from other devices using Bluetooth.
- Copying songs from other devices using Wi-Fi.

Listening to music

1. On the home screen, touch  .
2. Choose a category.

3. Touch the song you wish to play.

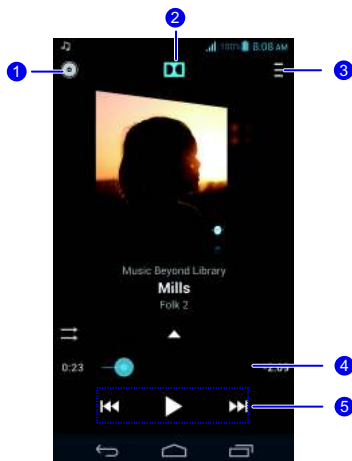



1 Touch  to enter the music library.

2 Touch  to enable or disable the Dolby Digital Plus.

3 Touch  to display the option menu from which you can perform additional operations.

4 Drag the slider to control the playback.

• Touch  to play and touch  to pause.

5 • Touch  to play the previous song.

• Touch  to play the next song.

i When a song is playing, touch  to exit the playback screen without stopping the song. To return to the music playback screen, open the notification panel and touch the playing song.

Creating a playlist

Creating playlists lets you be creative with your songs, and organize them into groups. Play the list that fits your mood the most.

1. On the home screen, touch .
2. Touch **Playlists > New playlist**.
3. Touch the text box to name the playlist.
4. Touch **Save**.
You can now add songs to the playlist.
5. In the displayed dialog box, touch **OK**.
6. Select the songs you wish to add.
7. Touch **Done**.

Playing a playlist

1. On the home screen, touch .
2. Touch **Playlists**.
3. Touch and hold the playlist you wish to play.
4. From the displayed option menu, choose **Play**.

Deleting a playlist

1. On the home screen, touch .
2. Touch **Playlists**.
3. Touch and hold the playlist you wish to delete.
4. From the displayed option menu, choose **Delete**.

Sharing a song

You can share your favorite songs with your family and friends using email, Bluetooth, and more.

1. On the home screen, touch .
2. Choose a category.
3. Touch and hold the song you wish to share.
4. From the displayed option menu, choose **Share**.
5. Choose a sharing method and follow the onscreen instructions.

Setting a song as the ringtone

Want to hear your favorite song whenever you receive an incoming call? Just make it your ringtone.



1. On the home screen, touch  .
2. Choose a category.
3. Touch and hold the song you wish to set as the ringtone.
4. From the displayed option menu, choose **Set as ringtone**.

Internet connection



Mobile data connection

After you insert a SIM card into your phone and power it on for the first time, your phone automatically registers with your service provider's data service.

Checking the network connection

1. On the home screen, touch  then the **All** tab.
 2. Under **WIRELESS & NETWORKS**, touch **Mobile networks**.
 3. Touch **Access Point Names** or **Network operators** to check network connection settings.
-  Your phone automatically reads access point settings from your SIM card. Do not change the access point settings; otherwise, you may not be able to access the network.

Enabling the data service

1. On the home screen, flick down from the status bar to open the notification panel.
 2. Touch  to enable your phone's data service.
-  When you don't need to access the Internet, disable the data service to save battery power and reduce data usage.

Setting up a Wi-Fi connection

When you use your phone at home, you can connect to the Wi-Fi hotspot created from your router. Some public locations, such as airports and libraries, may also have Wi-Fi networks available for use.

Connecting to a Wi-Fi network

1. On the home screen, touch  then the **All** tab.
 2. Under **WIRELESS & NETWORKS**, touch the Wi-Fi switch to turn on Wi-Fi.
 3. Under **WIRELESS & NETWORKS**, touch **Wi-Fi**.
- Your phone then scans for available Wi-Fi networks and displays them.

4. Choose the Wi-Fi network you wish to connect to and touch **Connect**.

For an encrypted Wi-Fi network, enter the password when prompted.



-  If Wi-Fi and mobile data are both enabled, your phone connects to the Wi-Fi network preferentially. When Wi-Fi becomes unavailable, your phone automatically switches to the mobile data connection.

Connecting to a Wi-Fi network using the WPS

The Wi-Fi protected setup (WPS) lets you quickly connect to a Wi-Fi network. A safe connection is set up by pressing the WPS button or entering the PIN, instead of complex settings on the management software of Wi-Fi hotspots, such as wireless routers.

-  To use the WPS function and set up a Wi-Fi connection between your phone and a Wi-Fi hotspot, make sure that the Wi-Fi hotspot also supports the WPS.

Using the WPS button

1. On the home screen, touch  then the **All** tab.
2. Under **WIRELESS & NETWORKS**, touch the Wi-Fi switch to turn on Wi-Fi.
3. On the Wi-Fi network list, touch .
4. On the Wi-Fi hotspot device, press the WPS button.

Using the WPS PIN

1. On the home screen, touch  then the **All** tab.
2. Under **WIRELESS & NETWORKS**, touch the Wi-Fi switch to turn on Wi-Fi.
3. On the Wi-Fi network list, touch .
4. Touch **Input WPS PIN**.
Your phone generates a PIN.
5. On the Wi-Fi hotspot device, enter the PIN.

Wi-Fi Direct

Wi-Fi Direct lets you easily connect two devices and transmit or share data between them.

Connecting two devices using Wi-Fi Direct

1. On the home screen, touch  then the **All** tab.

2. Under **WIRELESS & NETWORKS**, touch the Wi-Fi switch to turn on Wi-Fi.
3. On the Wi-Fi network list, touch  .
4. Touch **Wi-Fi direct**.
Your phone then scans for available devices and displays them.
5. Select a device.

Sending a file using a Wi-Fi network

1. Touch and hold the file you wish to send.
2. From the displayed option menu, choose **Share**.
3. Touch **Wi-Fi**.
4. Touch **Other devices**.

Your phone then scans for available devices and displays them.

5. Touch the device you wish to send the file to.

 The specific steps vary with the file type.

Receiving a file using a Wi-Fi network

When a file comes in, your phone displays the **File transfer** dialog box. To receive the file, touch **Accept**.

By default, received files are saved to the **Wi-Fi** folder in **File Manager**.

Sharing your phone's mobile data connection



Want to access the Internet from multiple devices when you are on the go? Use USB tethering or set your phone as a Wi-Fi hotspot to share its data connection with other devices.

USB tethering

You can share your phone's data connection with a computer using a USB cable.

To use USB tethering, you may need to install your phone's driver on the computer or establish a network connection, depending on your computer's operating system. If your computer runs Windows 7, Windows Vista, or a latest Linux operating system (such as Ubuntu 10.4), you can use your phone's USB tethering function without configuring any settings on the computer. If your computer runs an earlier version of Windows or another operating system, it will identify your phone and install its driver automatically.

1. Use a USB cable to connect your phone to the computer.

2. On the home screen, touch  then the **All** tab.
 3. Under **WIRELESS & NETWORKS**, touch **More....**
 4. Touch **Tethering & portable hotspot**.
 5. Select the **USB tethering** check box to share your phone's data connection.
-  You cannot use your phone's USB tethering function when the phone is in USB storage mode.



Bluetooth tethering

You can share your phone's mobile data connection with other devices using Bluetooth.

1. On the home screen, touch  then the **All** tab.
2. Under **WIRELESS & NETWORKS**, touch **More....**
3. Touch **Tethering & portable hotspot**.
4. Select the **Bluetooth tethering** check box.
5. On the Bluetooth device you wish to use, search for and connect to your phone.

Wi-Fi hotspot

Your phone can also function as a Wi-Fi hotspot for other devices, sharing its mobile data connection.

1. On the home screen, touch  then the **All** tab.
 2. Under **WIRELESS & NETWORKS**, touch **More....**
 3. Touch **Tethering & portable hotspot > Portable Wi-Fi hotspot settings > Configure Wi-Fi hotspot**.
 4. Name the Wi-Fi hotspot.
 5. Select an encryption mode.
-  It is recommended that you set the encryption mode to WPA2PSK to better secure the Wi-Fi network.
6. Set the key to the Wi-Fi hotspot.
When other devices want to access your phone's network, this key must be entered.
 7. Select the **Portable Wi-Fi hotspot** check box.

8. On the device you want to use, search for and connect to your phone's Wi-Fi network.

- i To manage the devices allowed to connect to your phone, touch **Manage allowed devices** and clear **Allow all devices to connect**. To add an allowed device, touch **Add device**.

Controlling your data usage

Your phone's data usage control function lets you check and control your data usage.

Set a data usage cycle and a mobile data limit for this period and you will be notified when data usage reaches this limit. You can also query the data usage within a certain period of time or data traffic consumed by an application.

1. On the home screen, touch  then the **All** tab.
2. Under **WIRELESS & NETWORKS**, touch **More....**
3. Touch **Data usage**.



1 Turn the mobile data connection on or off. To configure data control and query data usage, the mobile data connection must be turned on.

2 Turn the mobile data usage limit on or off.

3 Set the data usage cycle.
Touch **Data usage cycle** then **Change cycle...** to set the data usage cycle.

4 Set the data usage limits. The yellow line indicates the warning limit, and the red line indicates the data usage limit.
Drag the red and yellow lines to adjust the values or touch the lines to set specific values.
When your data usage reaches the yellow line, you will receive a warning notification. When your data usage reaches the red line, your phone's mobile data connection will be disabled.

5 Time axis.
Drag the time axes to set a data usage cycle.

6 Display the data usage of each application.

On the **Data usage** screen, touch  to open an option menu, from which you can:

- Turn data roaming on or off.
- Prevent background mobile data traffic.
- Turn automatic data synchronization on or off.
- Select the **Show Wi-Fi usage** check box. The **Wi-Fi** tab will be displayed. Touch this tab to view Wi-Fi data usage.
- Touch **Mobile hotspots** and select the Wi-Fi networks that are mobile hotspots to prevent applications from accessing these networks in the background. If an application is downloading a large file using these networks, you will be notified.

Sharing data

Bluetooth

Your phone is Bluetooth-capable, allowing you to connect to other Bluetooth-enabled devices for wireless data transmission. When using Bluetooth, stay within 10 meters (33 feet) of other Bluetooth devices.

Turning on Bluetooth

1. On the home screen, touch  then the **All** tab.
2. Under **WIRELESS & NETWORKS**, touch **Bluetooth**.

When Bluetooth is turned on, your phone's name is displayed at the top of the **Bluetooth** screen. Touch the name to set your phone's visibility.

-  To rename your phone, touch  > **Rename phone**. When you are done, touch **Rename** to save the changes.

Searching for and pairing with other Bluetooth devices

To exchange data with another Bluetooth device, enable Bluetooth on both devices and pair them with each other.

1. On the home screen, touch  then the **All** tab.
2. Under **WIRELESS & NETWORKS**, touch **Bluetooth**.
Your phone then scans for Bluetooth devices in range.
3. From the list of detected Bluetooth devices, touch a device and follow the onscreen instructions to pair with it.

To disconnect from a paired Bluetooth device, under **Paired devices**, touch  > **Unpair**.

-  If a Bluetooth connection cannot be set up between your phone and another device, they may be incompatible, in which case you will need to pair with a different device.

Transferring files using Bluetooth

Bluetooth enables you to conveniently send photos, videos, and other files to your family and friends. You can share files with Bluetooth-enabled devices without an Internet connection.

1. On the home screen, touch .
2. Touch and hold the file you wish to send.
3. From the displayed option menu, choose **Share > Bluetooth**.
4. From the detected Bluetooth device list, select a device.

Receiving files using Bluetooth

1. When your phone receives a file transfer request, open the notification panel.
2. Touch **Bluetooth share: Incoming file** to display a file reception dialog box.
3. Touch **Accept** to start receiving the file.

When the file is received, you will receive a notification of a successful transfer. Open the notification panel to read the notification. By default, received files are saved to the **bluetooth** folder in **File Manager**.

DLNA

The Digital Living Network Alliance (DLNA) aims to implement intercommunication between computers and other electronic products through wired and wireless networks, providing users with seamless digital media services. DLNA enables users on the same Wi-Fi network to share multimedia files easily. Using DLNA, you can:

- Share multimedia files with your friends.
 - Access multimedia files on other DLNA devices.
 - Play multimedia files on other devices and control the playback.
-  Before you use DLNA, make sure that your phone and other DLNA devices have connected to the same Wi-Fi network and DLNA is enabled on all devices.

On the home screen, touch **Tools >**  to display the DLNA screen. You can then share photos, videos, and songs with other DLNA devices, as well as view and download the multimedia files shared by other DLNA devices.

Connecting your phone to a computer

When you connect your phone to a computer using a USB cable, your phone will display a notification prompting you to select a connection type.

MTP mode

The Media Transfer Protocol (MTP) is used to transfer media files, such as pictures, songs, and videos, between your phone and a computer. Whether the MTP mode can be used depends on the version of Windows Media Player installed on the computer. Before you use this connection mode, make sure that Windows Media Player 10 or later has been installed.

1. Use a USB cable to connect your phone to the computer.
2. On the phone home screen, flick down from the status bar to open the notification panel.
3. Touch **USB computer connection** and select the **Media device (MTP)** check box. The phone driver is then automatically installed on the computer.
4. After the driver is installed, follow the onscreen instructions on the computer to view or transfer files.

PTP mode

The Picture Transfer Protocol (PTP) is another method to transfer pictures and videos to your computer.

1. Use a USB cable to connect your phone to the computer.
2. On the phone home screen, flick down from the status bar to open the notification panel.
3. Touch **USB computer connection** and select the **Camera (PTP)** check box. The phone driver is then automatically installed on the computer.
4. After the driver is installed, follow the onscreen instructions on the computer to view or transfer files.

HiSuite mode

HiSuite mode lets you back up and restore data in your phone, manage applications and application data, and synchronize data, such as contacts, messages, pictures, songs, videos, and calendar, between your phone and a computer.

1. Use a USB cable to connect your phone to the computer.
2. On the phone home screen, flick down from the status bar to open the notification panel.
3. Touch **USB computer connection** and select the **HiSuite** check box. The phone driver and HiSuite are then automatically installed on the computer.
4. From the displayed HiSuite window, perform your operations accordingly.

Mass storage mode

In mass storage mode, you can use your phone as a USB mass storage device and transfer files between your phone and a computer.

1. Use a USB cable to connect your phone to the computer.
2. On the phone home screen, flick down from the status bar to open the notification panel.
3. Touch **USB computer connection** and select the **USB mass storage** check box.
The phone driver is then automatically installed on the computer.
4. Transfer files between your phone and the computer.

! After file transmission, safely remove the device on the computer and disconnect it from the USB cable to prevent your data from being lost or corrupted.

Connecting your phone to a USB storage device

You can connect your phone to a USB storage device directly using the provided USB OTG cable to transfer data. Compatible USB storage devices include USB flash drives, card readers, and phones that work as USB mass storage devices.

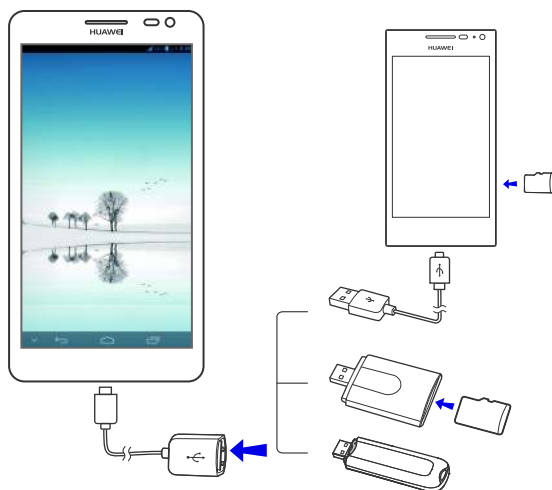

To connect your phone to another phone, make sure that the phone you wish to connect to supports the USB mass storage function and has a microSD card installed. To establish the connection and read data stored on the microSD card:

1. Use a USB OTG cable and USB cable to connect the two phones.
2. Enable the USB mass storage function on the phone from which you wish to read data.
3. On your phone's home screen, touch  then the **All** tab.
4. Touch **Storage > Mount USB storage**.
5. Read data from the microSD card of the other device.

 Do not remove a storage device from your phone before unmounting; otherwise, data may become corrupted. Before removing the device, touch



on the home screen. Then touch **All > Storage > Unmount USB storage** to unmount the USB device.



-  Your phone supplies power to USB storage devices. Certain phone models and mobile hard drives have relatively high rates of power consumption, meaning your phone may not be able to supply enough power for them to run properly.

File Manager

File Manager helps you manage files and applications in your phone's internal storage and microSD card. You'll be able to view, create, edit, delete, move, archive, compress, and decompress files.



Creating a folder

You can create folders to better manage the files and applications stored in your phone's internal storage or microSD card.

1. On the home screen, touch .
2. Touch **Internal** or **SD card**.
3. Touch  > **New folder**.
4. In the displayed dialog box, name the new folder.
5. Touch **Save**.

Searching for a file

Too many files stressing you out? The search function helps you find what you need in no time.

1. On the home screen, touch .
2. Touch **Internal** or **SD card**.
3. Touch  > **Search**.
4. Enter part or all of the file name.
5. Touch  in the lower right corner of the keyboard.

Copying or cutting a file

1. On the home screen, touch .
2. Touch and hold the file you wish to copy or cut.
3. From the displayed option menu, choose **Copy** or **Cut**.

4. Select where you wish to paste the file.
5. Touch **Paste**.

Compressing or decompressing files

You can compress files into .zip files to save space or decompress .zip and .rar files.

1. On the home screen, touch .
2. Touch and hold the file or folder you wish to compress.
3. From the displayed option menu, choose **Compress**.
4. Choose the save path of the compressed file and name it.
5. Touch **OK**.

To decompress a file, touch and hold it and choose **Extract** from the displayed option menu.

Renaming a file

1. On the home screen, touch .
2. Touch and hold the file you wish to rename.
3. From the displayed option menu, choose **Rename**.
4. In the displayed dialog box, enter a new name for the file.
5. When you are done, touch **OK**.

Deleting a file

1. On the home screen, touch .
2. Touch and hold the file you wish to delete.
3. From the displayed option menu, choose **Delete**.
4. Touch **OK**.



Creating a shortcut for a file or folder

1. On the home screen, touch .
2. Touch the file or folder you wish to create a shortcut for.

3. From the displayed option menu, choose **Desktop shortcuts**.

Checking the memory status

Before you save large files to your phone's internal storage or microSD card, make sure there is enough space first.

1. On the home screen, touch  .
2. Touch  > **Storage**.
3. On the **Storage settings** screen, view the total and available spaces of your phone's internal storage or microSD card.



Managing applications



Downloading applications

A rich selection of applications are available to download through an application store, such as Google's **Play Store**. You can also connect your phone to a computer and transfer applications over that way.

Installing an application

- It is recommended that you use **Play Store** as your primary download source. Certain third-party applications from other sources may not be compatible with your phone.

- On the home screen, touch **Management** > .
- Select the application you wish to install.
- Touch  > **Install**.
- Touch **Done**.

- During the installation, a **Install blocked** message may be displayed. Read the message carefully. If you want to continue with the installation, touch  then **All** > **Security**, and select the **Unknown sources** check box to allow installation of third-party applications. Then touch  to proceed.

Viewing applications

You can view detailed information about all applications installed on your phone.

- On the home screen, touch  then the **All** tab.
- Under **APPS**, touch **Manage apps**.
- Flick to **ALL**.
- Select the application you wish to view.

Uninstalling an application

You can remove unwanted applications to increase your phone's available storage.

1. On the home screen, touch  then the **All** tab.
2. Under **APPS**, touch **Manage apps**.
3. Flick to **ALL**.
4. Select the application you wish to uninstall.
5. Touch **Uninstall** > **OK**.

 Some pre-installed applications cannot be uninstalled.

Clearing the application cache

You can clear the application cache to free up the phone memory.

1. On the home screen, touch  then the **All** tab.
2. Under **APPS**, touch **Manage apps**.
3. Flick to **ALL**.
4. Touch **Clear cache**.

Backup

Backup lets you back up your important data and restore them after a system upgrade or reset.

Backing up data to local storage

1. On the home screen, touch **Management** >  .
2. Touch **Back up to SD card**.
3. Select the data you wish to back up.
4. Touch **Backup**.
5. Enter a password when prompted.
6. Touch **Backup**.

By default, backup files are saved to the **HuaweiBackup** folder in **File Manager**.

Restoring data from local storage

1. On the home screen, touch **Management** >  .
2. Touch **Restore from SD card**.
3. From the backup file list, choose the file you wish to restore.
4. Enter the backup password.
5. Touch **OK**.
6. Touch **Restore**.

Google services



To use Google services, sign in with a Google account. If you don't have one, open a Google application and follow the onscreen instructions to create your Google account.

- Google applications, services, and functions vary with country and service provider. Please follow local laws and regulations when you use Google services.





Gmail

Gmail is Google's official email service. When you first use **Gmail**, emails on your web account will be synchronized to your phone.

Sending emails

1. On the home screen, touch **Google Apps** >  to open your mailbox.
If you have added more than one Gmail account, select the one you wish to use.
2. Touch .
3. Enter the recipient and subject and compose your message.
4. Touch .



Checking your emails

1. On the home screen, touch **Google Apps** >  to enter your mailbox.
If you have more than one Gmail account, select the one you wish to use.
2. From the email list, select the email you wish to read.
 - Touch  to reply to the sender.
 - Touch  > **Reply all** to reply to all.
 - Touch  > **Forward** to forward the email.

Talk



Talk is an instant chat application provided by Google. With **Talk**, you can reach friends using messages, or voice and video chats.

Adding a friend

1. On the home screen, touch **Google Apps** >  .
2. Touch  .
3. Enter the email address of your friend.
4. Touch  .

If the recipient accepts your invitation, he or she will appear in your friend list.

Starting a conversation

1. On the home screen, touch **Google Apps** >  .
2. From your friend list, touch the one you wish to talk to.
3. Compose your message.
4. Touch  .

Maps



Maps helps you find out where you are, shows you how to get to a destination, and displays real-time traffic. Satellite view is also available.

Turning on location services

Before you use **Maps** to search for a location, turn on your location services.



1. On the home screen, touch  then the **All** tab.
2. Touch **Location access**.
3. Select the **Wi-Fi & mobile network location** and **GPS satellites** check boxes.

Searching for places of interest

1. On the home screen, touch **Google Apps** >  .
2. Touch  .
3. Enter the location you wish to search for.

4. Touch  in the lower right corner of the keyboard.
The search results are marked on the map by letters.
5. Touch a mark to see how to get there and view more details about the location.



Checking how to get to a place

1. When you browse a map, touch .
2. Touch the first text box to enter the start point. Then, touch the second text box to enter the destination.
3. Select a transportation method: by car, public transportation, or foot.
4. Touch **Go**.
Available routes are then shown in a list.
5. Touch the route you prefer to display on the map.
6. To start a new search, touch  > **CLEAR MAP** to clear the search results.

YouTube

YouTube is Google's online video-sharing website, where you can search for, watch, and upload videos.

Searching for a video

1. On the home screen, touch **Google Apps** > .
2. Touch .
3. Enter the keywords.
4. Touch  in the lower right corner of the keyboard.
5. From the search results, touch a video.

Sharing a video

From the video list, select the video you wish to share. Then, touch  and select a sharing method.



Play Store

Play Store is an application market provided by Google, where you can download applications and games.

Installing an application

1. On the home screen, touch  .
2. Find the desired application.
3. Follow the onscreen instructions to download and install it.

Uninstalling an application

1. On the home screen, touch  .
2. Touch  > **My Apps**.
3. From the application list, touch the application you wish to uninstall.
4. Touch **Uninstall** > **OK** to uninstall the application.



Basic utilities

Your phone comes with a variety of useful tools, such as **Calendar**, **Clock**, and **Calculator**, helping you keep yourself organized.

Calendar

Calendar is your personal assistant that helps you manage, arrange, and keep track of all important events.

Creating an event

1. On the home screen, touch .
2. Touch  > **New event**.
3. Enter event details, such as the event name, time, and location.
4. Touch .

 You can also touch any date on the calendar to create an event.



Viewing events

1. On the home screen, touch .
2. Touch the time in the upper left corner to switch between day, week, month, and agenda views.

The agenda view displays all your calendar events, which lets you know your schedule at a glance.



Sharing an event

You can share an event with your family and friends in a number ways, such as Bluetooth.



1. On the home screen, touch .
2. Open an event you wish to share.
3. Touch  > **Send event**.
4. Select a sharing method and follow the onscreen instructions.

Synchronizing and viewing events

Calendar events in your accounts (such as an email account) can be synchronized to and viewed on the **Calendar** application.

1. On the home screen, touch .
2. Touch  > **Calendars to display**.
3. Select the account whose calendar you wish to display.
4. Touch  > **Calendars to sync**.
5. Select the account from which you wish to synchronize calendar events.
6. Touch **OK**.



Modifying calendar settings

1. On the home screen, touch .
2. Touch  > **Settings**.
3. Follow the onscreen instructions to configure the calendar settings.

Clock

Clock lets you view the time around the world, use stopwatch or timer to keep track of time, or set alarms to wake you up in the morning.

Adding an alarm



1. On the home screen, touch .
2. From the alarm list, touch .
3. Set the alarm time, ringtone, how often it repeats, and more.
4. Touch **DONE**.

 Enabled alarms will go off even when your phone is powered off.

Deleting an alarm

1. On the home screen, touch .
2. From the alarm list, touch and hold the alarm you wish to delete.
3. From the displayed option menu, choose **Delete alarm**.
4. Touch **OK**.

Configuring alarm settings

1. On the home screen, touch .
2. From the alarm list, touch  > **Settings**.
3. On the alarm settings screen, set the ringing mode, snooze duration, and more.





Calculator

Calculator lets you make simple or complex calculations.

1. On the home screen, touch **Tools** > .
2. On the **Calculator** screen, flick left or right to switch between the advanced and basic panels.

Notes

Notes is a handy application that lets you record quick thoughts or important information.

1. On the home screen, touch **Tools** > .
 2. Touch **Add note**.
 3. Enter what you wish to record.
 4. When you are done, touch .
-  On the **Notes** screen, you can touch  and select one or more notes to delete them at a time, or select **All** to delete all notes.

Weather

Weather provides you with the latest weather information for any city around the world. You can share weather information with your family and friends.

-  Before you use **Weather**, turn on your phone's GPS and data service.

Adding a city

You can add cities you like to **Weather** and check their weather information.

1. On the home screen, touch **Tools** > .

2. Touch  > .

 Apart from your current city, you can add up to nine cities.

3. Enter a city name.

Matching cities are then displayed.

4. Select the city you wish to add.

Setting the default city

1. On the home screen, touch **Tools** > .

2. Touch  > .

3. Touch the city you wish to set as the default city.

Deleting a city

1. On the home screen, touch **Tools** > .

2. Touch  > .



3. Select the city you wish to delete, and touch **DELETE**.

Updating weather

1. On the home screen, touch **Tools** > .

2. Flick left or right to find the city whose weather you wish to update.

3. Touch  to update the weather.

 You can also set **Weather** to automatic update mode. Touch  > , select **Auto update**, and set **Update interval**. Your phone will then update the weather at the interval you set.

Sharing weather information

Your phone lets you send weather information as a text message to remind your family and friends of weather changes.

1. On the home screen, touch **Tools** > .

2. Flick left or right to find the city whose weather you wish to share.

3. Touch  to display the messaging screen.

4. You can then:

- Enter a phone number.
- Touch  to select a contact.

5. Touch  to send the weather information to the recipient.

FM radio





Want to listen to your favorite broadcast programs? Open **FM Radio** anytime anywhere you like.

-  Connect a headset to the phone. **FM Radio** utilizes the headset as an antenna.

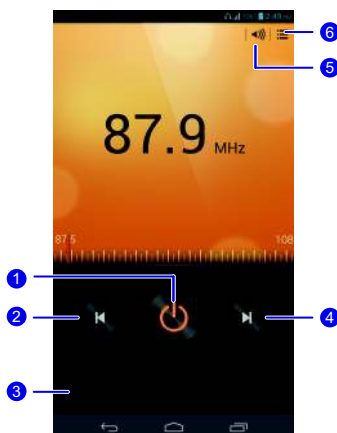
Listening to FM radio

On the FM radio screen, you can perform the following operations:



-
- 1** Touch  to turn the FM radio on or off.
-
- 2** Touch  to return to the previous station.
-
- 3** Touch  to add the station to your favorites.
-
- 4** Touch  to go to the next station.
-

5 Touch  to enable or disable the speaker.

6 Touch  to display the station list.

Accounts and sync

You can synchronize data on your phone, such as contacts, emails, and events, to and from the Internet.



Adding an account

1. On the home screen, touch  then the **All** tab.
2. Under **ACCOUNTS**, touch **Add account**.
3. Select an account type.
4. Follow the onscreen instructions and enter your account information.
5. Configure the account and set the type of data you wish to synchronize.

When an account is set up, it will be shown in the **ACCOUNTS** section.



-  The types of data you can synchronize to your phone vary with account type.

Deleting an account

1. On the home screen, touch  then the **All** tab.
2. Under **ACCOUNTS**, select an account type.
3. Select the account you wish to delete.
4. Touch  > **Remove account**.
5. In the displayed dialog box, touch **Remove account**.

Turning on data synchronization

1. On the home screen, touch  then the **All** tab.
2. Under **ACCOUNTS**, select an account type.
3. Select the account you wish to synchronize from.
4. Touch the data you wish to synchronize.

-  You can touch  > **Sync now** to have the data synchronization run in the background.

Modifying account synchronization settings

1. On the home screen, touch  then the **All** tab.
2. Under **ACCOUNTS**, select an account type.
3. Select the account whose synchronization settings you wish to modify.
4. Under **Sync settings**, select the data you wish to synchronize.

Settings

Turning on or off airplane mode

Your phone's signal reception or transmission may interfere with an airplane's flight system. Power off your phone or switch to airplane mode when you are on a flight.

In airplane mode, your phone's wireless features are disabled, but you can still listen to music or play games.

Use either of the following methods to turn on or off **Airplane mode**:

- Press and hold the power button. From the displayed option menu, choose **Airplane mode**.
- On the home screen, touch  then the **All** tab. Under **WIRELESS & NETWORKS**, touch **Airplane mode**.

When airplane mode is on,  appears in the status bar.

Tone settings

1. On the home screen, touch  then the **All** tab.
2. Under **DEVICE**, touch **Sound**.
3. From the settings screen, you can:
 - Touch **Volume** and drag the sliders to set the volume of music, ringtone, message notification tone, and more.
 - Touch **Vibration** to set whether your phone vibrates when you have an incoming call, message, email, event, and more.
 - Touch **Silent mode** to turn silent mode on or off.
 - Touch **Phone ringtone** to select a ringtone.
 - Touch **Notification tone** to select a tone for messages, emails, events, and more.
 - Touch **Dolby Digital Plus Settings** to turn the Dolby sound effect on or off.
 - Touch **System** to turn the notification tone or vibration on or off when you touch or lock the screen, take a screenshot, dial a number, and more.

- You can adjust the volume from the home screen or most applications, such as call, music, and video.

Display settings

1. On the home screen, touch  then the **All** tab.
2. Under **DEVICE**, touch **Display**.
3. On the settings screen, you can:
 - Touch **Color temperature** to adjust the screen color temperature. To manually adjust the color temperature, clear the **Default** check box.
 - Touch **Brightness** to set the screen brightness. To manually adjust the brightness, clear the **Automatic brightness** check box.
 - Touch **Wallpaper** to set the lock screen and home screen wallpapers.
 - Touch **Auto-rotate screen** to turn the screen auto-rotate function on or off. If this function is turned on, your screen's orientation will automatically change with the way you hold your phone when you perform certain operations, such as browsing a web page, viewing a picture, or writing a message.
 - Touch **Smart backlight** to turn smart backlight function on or off. If this function is turned on, your phone automatically adjusts the screen brightness based on the content displayed on it.
 - Touch **Sleep** to set a screen timeout period. If idle for the specified period, your phone automatically locks its screen to save battery power.
 - Touch **Font size** to change the display font size.

Turning on the power manager

1. On the home screen, touch  then the **All** tab.
2. Under **DEVICE**, touch **Power Manager**.
3. From the settings screen, you can:
 - Touch **Intelligent mode** to save power and maximize the standby time.
 - Touch **Normal mode** to enable normal power saving mode.

- Touch **Optimum performance** to have your phone work in its best performance mode without any power saving operations.

Setting the date and time

By default, your phone relies on the network-based date and time. You can also manually set the date and time.

1. On the home screen, touch  then the **All** tab.
2. Under **SYSTEM**, touch **Date & time**.
3. From the settings screen, you can:
 - Clear the **Automatic date & time** check box to stop your phone from automatically obtaining the network date and time.
 - Clear the **Automatic time zone** check box to stop your phone from automatically obtaining the network time zone.
 - Touch **Set date** and flick up and down to set your phone's date.
 - Touch **Set time** and flick up and down to set your phone's time.
 - Touch **Select time zone** and select the time zone from the list. Scroll up or down to view more time zones.
 - Select or clear the **Use 24-hour format** check box to switch between the 12-hour and 24-hour formats.
 - Touch **Select date format** to select how you wish the date to be displayed.

Changing the system language

1. On the home screen, touch  then the **All** tab.
2. Under **PERSONAL**, touch **Language & input**.
3. Touch **Language**.
4. From the list, choose a language.

Modifying location service settings

You can modify your phone's location service settings for more convenient positioning and navigation services.

1. On the home screen, touch  then the **All** tab.
2. Under **PERSONAL**, touch **Location access**.
3. From the settings screen, you can:
 - Touch **Access my location** to enable your phone to use your location information.
 - Touch **GPS satellites** to have your phone obtain your location information from GPS satellites.
 - Touch **Wi-Fi & mobile network location** to have your phone obtain your location information from a Wi-Fi network or mobile data connection.

Setting the PIN of your SIM card

The personal identification number (PIN) is delivered with your SIM card. If you enable the PIN protection function for your SIM card, you will need to enter the PIN each time you power your phone on.

Before you perform the following operations, make sure that you have obtained your SIM card's PIN from your service provider.

1. On the home screen, touch  then the **All** tab.
2. Under **PERSONAL**, touch **Security**.
3. Touch **Set up SIM card lock**.
4. Select the **Lock SIM card** check box.
5. Enter the PIN.
6. Touch **OK**.

 If you incorrectly enter the PIN a specified number of consecutive times, the PIN is blocked and the phone prompts you to enter the PIN unblocking key (PUK). If you incorrectly enter the PUK a specified number of consecutive times, the SIM card will be disabled permanently. For details about the maximum retry attempts for the PIN and PUK, contact your service provider.

Restoring factory settings

Restoring your phone to its factory settings erases all your personal data from the phone, including your email accounts, system and application settings, and installed applications.

 Back up important data on your phone before you restore factory settings.

1. On the home screen, touch  then the **All** tab.
2. Under **PERSONAL**, touch **Backup & reset**.
3. Tap **Factory data reset** > **Reset phone** > **Reset phone**.

The phone will restore its factory settings and restart.

Online update

Once in a while, new updates for your phone will be available online. You will receive a notification when updates are available. Before updating, make sure that your phone has enough storage space for the update package.

To update manually, on the home screen, touch  > **About phone** > **System updates** to check for updates and follow the onscreen instructions to update your phone online.

 All your personal data may be erased during a system update. It is recommended that you back up important data before updating your phone.

Accessibility







You can turn on or off preset or installed accessibility features.

1. On the home screen, touch  then the **All** tab.
2. Under **SYSTEM**, touch **Accessibility**.
3. Select the features you wish to turn on or off.

FAQs

For more information, please visit <http://www.huaweidevice.com/worldwide/faq.do?method=index&directoryId=50>.

How can I save battery power?

- When you do not need Internet access, open the notification panel and touch  to turn off your mobile data connection.
- When you do not need wireless data services, such as GPS, Bluetooth, or Wi-Fi, open the notification panel, and touch , , or  to turn off these services.
- Touch  > **All** > **Display** to reduce the screen brightness and screen timeout period. Press  to turn off the screen when your phone is not in use.
- Close applications that are not in use.
- Decrease the tone volume.

How can I free up additional phone memory?

- Move files and email attachments to a microSD card.
- Open the browser and delete locally cached content.
- Uninstall applications you no longer use.
- Restore your phone to its factory settings.

How can I use a microSD card to import contacts from another phone?

Your phone supports contact files in .vcf format only.

1. Save the contacts you wish to import as a .vcf file and save the file to a microSD card.
2. Insert the microSD card into your phone. Touch **File Manager** then **SD card** to find the .vcf file.
3. Touch the .vcf file. The phone displays a message asking whether you wish to import the contacts.
4. Touch **OK** to import the contacts.

-  Compatibility issues may occur with .vcf files created by other phones and certain contact information may be lost during the import.

How can I set a song as my ringtone?

In **Music**, touch and hold the song you wish to set as the ringtone. From the displayed option menu, choose **Set as ringtone**.

How can I disable the Auto-rotate screen function?

On the home screen, touch  then **All > Display**, and clear **Auto-rotate screen**.

How can I set a screen unlock pattern?

On the home screen, touch  then **General > Screen lock > Screen lock > Pattern**, and follow the onscreen instructions to set a screen unlock pattern.

How can I switch the input method?

When you write text, open the notification panel and touch **Choose input method** to select an input method.

How can I stop the song playing in the background?

Open the notification panel, touch the playing song to display the music playback screen, and stop the playback.

How can I return to the call screen?

To return from another screen during a call, open the notification panel and touch the ongoing call.

How can I move an application icon on the home screen?

On the screen, touch and hold the application icon you wish to move and drag it to a new location.

How can I hide the onscreen keyboard?

Touch  to hide the keyboard.

How can I forward a message?

Touch and hold the message you wish to forward, and choose **Forward** from the displayed option menu.

How can I restart my phone?

Press and hold , and touch **Restart > OK** to restart your phone.

How can I remove the black borders that sometimes appear on the bottom of third-party applications?

When some third-party applications are running and you touch  to hide the navigation bar, a black border appears on the bottom of the screen. This is caused by the application's layout limitations. For most cases, simply hide the navigation bar and re-open the application to remove the border.

Legal Notice

Copyright © Huawei Technologies Co., Ltd. 2013. All rights reserved.

No part of this manual may be reproduced or transmitted in any form or by any means without prior written consent of Huawei Technologies Co., Ltd. and its affiliates ("Huawei").

The product described in this manual may include copyrighted software of Huawei and possible licensors. Customers shall not in any manner reproduce, distribute, modify, decompile, disassemble, decrypt, extract, reverse engineer, lease, assign, or sublicense the said software, unless such restrictions are prohibited by applicable laws or such actions are approved by respective copyright holders.

Trademarks and Permissions



HUAWEI HUAWEI



and  are trademarks or registered trademarks of Huawei Technologies Co., Ltd.

Manufactured under license from Dolby Laboratories. Dolby and the double-D symbol are registered trademarks of Dolby Laboratories.

Android™ is a trademark of Google Inc.

The *Bluetooth*® word mark and logos are registered trademarks owned by *Bluetooth SIG, Inc.* and any use of such marks by Huawei Technologies Co., Ltd. is under license.

Other trademarks, product, service and company names mentioned may be the property of their respective owners.

Notice

Some features of the product and its accessories described herein rely on the software installed, capacities and settings of local network, and therefore may not be activated or may be limited by local network operators or network service providers.

Thus, the descriptions herein may not exactly match the product or its accessories which you purchase.

Huawei reserves the right to change or modify any information or specifications contained in this manual without prior notice and without any liability.

Third-Party Software Statement

Huawei does not own the intellectual property of the third-party software and applications that are delivered with this product. Therefore, Huawei will not provide any warranty of any kind for third party software and applications. Neither will Huawei provide support to

customers who use third-party software and applications, nor be responsible or liable for the functions or performance of third-party software and applications.

Third-party software and applications services may be interrupted or terminated at any time, and Huawei does not guarantee the availability of any content or service. Third-party service providers provide content and services through network or transmission tools outside of the control of Huawei. To the greatest extent permitted by applicable law, it is explicitly stated that Huawei shall not compensate or be liable for services provided by third-party service providers, or the interruption or termination of third-party contents or services.

Huawei shall not be responsible for the legality, quality, or any other aspects of any software installed on this product, or for any uploaded or downloaded third-party works in any form, including but not limited to texts, images, videos, or software etc. Customers shall bear the risk for any and all effects, including incompatibility between the software and this product, which result from installing software or uploading or downloading the third-party works.

This product is based on the open-source Android™ platform. Huawei has made necessary changes to the platform. Therefore, this product may not support all the functions that are supported by the standard Android platform or may be incompatible with third-party software. Huawei does not provide any warranty or representation in connect with any such compatibility and expressly excludes all liability in connection with such matters.

DISCLAIMER

ALL CONTENTS OF THIS MANUAL ARE PROVIDED "AS IS". EXCEPT AS REQUIRED BY APPLICABLE LAWS, NO WARRANTIES OF ANY KIND, EITHER EXPRESS OR IMPLIED, INCLUDING BUT NOT LIMITED TO, THE IMPLIED WARRANTIES OF MERCHANTABILITY AND FITNESS FOR A PARTICULAR PURPOSE, ARE MADE IN RELATION TO THE ACCURACY, RELIABILITY OR CONTENTS OF THIS MANUAL.

TO THE MAXIMUM EXTENT PERMITTED BY APPLICABLE LAW, IN NO EVENT SHALL HUAWEI BE LIABLE FOR ANY SPECIAL, INCIDENTAL, INDIRECT, OR CONSEQUENTIAL DAMAGES, OR LOSS OF PROFITS, BUSINESS, REVENUE, DATA, GOODWILL SAVINGS OR ANTICIPATED SAVINGS REGARDLESS OF WHETHER SUCH LOSSES ARE FORSEEABLE OR NOT.

THE MAXIMUM LIABILITY (THIS LIMITATION SHALL NOT APPLY TO LIABILITY FOR PERSONAL INJURY TO THE EXTENT APPLICABLE LAW PROHIBITS SUCH A LIMITATION) OF HUAWEI ARISING FROM THE USE OF THE PRODUCT DESCRIBED IN THIS MANUAL SHALL BE LIMITED TO THE AMOUNT PAID BY CUSTOMERS FOR THE PURCHASE OF THIS PRODUCT.

Import and Export Regulations

Customers shall comply with all applicable export or import laws and regulations and be responsible to obtain all necessary governmental permits and licenses in order to export, re-export or import the product mentioned in this manual including the software and technical data therein.

Privacy Policy

To better understand how we protect your personal information, please see the privacy policy at <http://consumer.huawei.com/en/privacy-policy/index.htm>.

Index

A

Accessibility	87
Accessing a bookmark	40
Accounts and sync	81
Adding a bookmark	40
Adding a city	77
Adding a contact to your favorites	34
Adding a home screen	22
Adding a POP3 or IMAP email account	42
Adding a profile	23
Adding a widget to the home screen	20
Adding a widget unit	21
Adding an account	81
Adding an alarm	76
Adding an Exchange account	42
Adding songs	50
Adjusting the screen brightness	26
Android input method	16
Answering a call	27
Answering a third-party call	29
Auto-rotate screen	12

B

Backing up data to local storage	70
Backup	70
Battery indicator	6
Bluetooth tethering	57
Browsing web pages	40

C

Calculator	77
Calendar	75
Changing message tone and other tones	24
Changing the account synchronization settings	82
Changing the font size	24
Changing the profile	23
Changing the system language	85

Changing the theme	19
Changing the wallpaper	19
Charging the battery	6
Checking the memory status	67
Checking your emails	43
Clearing the application cache	69
Clearing your browsing history	41
Compressing files	66
Configuring alarm settings	77
Configuring calendar settings	76
Connecting to a Wi-Fi network	54
Connecting to a Wi-Fi network using the WPS button	55
Connecting to a Wi-Fi network using the WPS PIN	55
Connecting two devices using Wi-Fi Direct	55
Connecting your phone to a computer	61
Connecting your phone to a USB storage device	63
Controlling your data usage	58
Copying a file	65
Copying a message	38
Copying contacts	32
copyright	90
Creating a contact	32
Creating a contact group	35
Creating a folder	65
Creating a folder on the home screen	20
Creating a playlist	51
Creating a shortcut for a file or folder	66
Creating an event	75
Cropping a photo	49
Customizing a theme	19
Customizing switch shortcuts on the notification panel	23
Cutting a file	65
D	
Decompressing a file	66
Deleting a city	78
Deleting a contact	34
Deleting a contact group	36
Deleting a file	66
Deleting a home screen	22

Deleting a message	39
Deleting a photo	49
Deleting a playlist	52
Deleting a profile	23
Deleting a thread	39
Deleting an account	81
Deleting an alarm	76
Deleting an application icon or widget	20
disclaimer of warranties	91
Display settings	84
Displaying suspend windows	14
DLNA	61
E	
Editing a bookmark	40
Editing a contact group	35
Editing a photo	49
Editing text	17
Enabling call forwarding	30
Enabling call waiting	30
Enabling the data service	54
Export contacts	33
export regulations	92
F	
Face unlock	25
FM radio	79
Forwarding a message	38
Freeing up the phone memory	88
G	
Gestures	8
Getting to know your home screen	9
H	
Hiding the navigation bar	13
HiSuite mode	62
Huawei input method	15
I	
import regulations	92
Important information about the battery	6
Importing contacts from a Bluetooth device	33

Importing contacts from a storage device	33
Importing or exporting contacts	33
Inserting a microSD card	5
Inserting a Micro-SIM card	4
Installing an application	68
J	
Joining contacts	34
L	
Listening to FM radio	79
Listening to music	50
Locking a message	39
Locking the screen	9
M	
Making a conference call	29
Making emergency calls	29
Mass storage mode	63
Modifying browser settings	41
Modifying email account settings	44
Modifying location service settings	86
Modifying message settings	39
Moving a widget unit	22
MTP mode	62
N	
Notes	77
notice	90
O	
Obtaining applications	68
Online update	87
P	
Pairing with another Bluetooth device	60
permissions	90
Phone appearance and buttons	4
Photo taking screen	45
Playing a playlist	52
Playing a slideshow	48
Powering off	7
Powering on	7

PTP mode	62
R	
Re-arranging home screens	22
Receiving a file using a Wi-Fi network	56
Receiving files using Bluetooth	61
Rejecting a call	27
Rejecting a call using a text message	27
Removing a microSD card	6
Removing a widget unit	21
Removing an email account	44
Removing an item from a folder	21
Renaming a file	66
Replying to a message	37
Restoring data from local storage	70
Restoring to factory settings	87
Rotating a photo	49
S	
Safety precautions	2
Searching for a contact	32
Searching for a file	65
Searching for a message	38
Selecting an input method	15
Sending a file using a Wi-Fi network	56
Sending a multimedia message	37
Sending a text message	37
Sending emails	43
Sending messages or emails to a contact group	36
Setting a photo as the wallpaper	50
Setting a song as the ringtone	52
Setting the date and time	85
Setting the default city	78
Setting the home page	41
Setting the home screen transition effect	19
Setting the PIN of your SIM card	86
Setting the ringtone	24
Setting up your phone for the first time	7
Setting up your voicemail	30
Sharing a photo or video	50
Sharing a song	52

Sharing an event	75
Sharing contacts	35
Sharing weather information	78
Shooting a video	46
Smart dialing	27
Splitting contacts	34
Starting applications and switching between them	15
Status icons	10
Switching between email accounts	43
Switching between home screens	12
Synchronizing and viewing calendar events	76
T	
Taking a beauty-mode photo	47
Taking a group picture	47
Taking a panoramic photo	46
Taking a photo	46
Taking a screenshot	12
third-party software statement	90
Tone settings	83
trademarks	90
Transferring files using Bluetooth	60
Turning on Bluetooth	60
Turning on data synchronization	81
Turning on gloves mode	14
Turning on one-hand operations	14
Turning on or off airplane mode	83
Turning on the power manager	84
U	
Uninstalling an application	68
Unlocking the screen	9
Unlocking the screen with a password	26
Unlocking the screen with a pattern	25
Updating weather	78
USB tethering	56
Using Bluetooth	60
Using HDR	48
Using the notification panel	13

V

Viewing applications	68
Viewing photos or videos	48
Viewing recently used applications	15
Viewing the call log	28

W

Weather	77
What you can do during a call	28
Wi-Fi hotspot	57

This guide is for reference only. The actual product, including but not limited to the color, size, and screen layout, may vary. All statements, information, and recommendations in this guide do not constitute a warranty of any kind, express or implied.

Please visit www.huaweidevice.com/worldwide/support/hotline for recently updated hotline and email address in your country or region.

Model: HUAWEI MT1-U06
V100R001C00_01