

Dell Gaming Monitor - G2524H

User's Guide

Monitor Model: G2524H
Regulatory Model: G2524Hf



 **NOTE:** A NOTE indicates important information that helps you make better use of your computer.

 **CAUTION:** A CAUTION indicates potential damage to hardware or loss of data if instructions are not followed.

 **WARNING:** A WARNING indicates a potential for property damage, personal injury, or death.

Copyright © 2023 Dell Inc. or its subsidiaries. All rights reserved. Dell, EMC, and other trademarks are of Dell Inc. or its subsidiaries. Other trademarks may be trademarks of their respective owners.

2023 - 06

Rev. A00

Contents

Safety instructions	6
About your monitor	7
Package contents.....	7
Product features	9
Identifying parts and controls	11
Front view	11
Side view.....	11
Back view	12
Bottom view	13
Monitor specifications	14
Resolution specifications	16
Supported video modes	16
Preset display modes.....	17
Electrical specifications.....	18
Physical characteristics.....	19
Environmental characteristics	20
Pin assignments.....	21
Universal Serial Bus (USB) interface	23
USB 3.2 Gen1 (5Gbps) upstream connector	23
USB 3.2 Gen1 (5Gbps) downstream connector.....	24
USB ports	24
Plug and play capability	25
LCD monitor quality and pixel policy.....	25
Ergonomics	25
Handling and Moving Your Display.....	27
Maintenance guidelines	29
Cleaning your monitor	29



Setting up the monitor	30
Attaching the stand.....	30
Connecting your monitor	33
Connecting the DisplayPort (DP to DP) cable and the power cable	34
Connecting the USB Type-C to DisplayPort cable and the power cable	34
Connecting the HDMI cable and the power cable	34
Connecting the SuperSpeed USB 5Gbps (USB 3.2 Gen1) cable and the power cable	35
Organizing your cables	37
Securing your monitor using Kensington lock (optional) .	37
Removing the monitor stand	38
VESA wall mounting (optional)	39
Operating the monitor	40
Power on the monitor	40
Using the joystick control	40
Using the rear-panel controls	41
Using the On-Screen Display (OSD) menu	42
Accessing the menu system	42
Vision Engine.....	54
OSD warning message.....	56
Locking the rear-panel control buttons.....	59
Setting the maximum resolution	61
Setting the maximum frame rate	62





Using the tilt and vertical extension	63
Tilt and swivel extensions	63
Vertical extension.....	64
Rotating the display	64
Rotate clockwise.....	65
Rotate counterclockwise.....	65
Adjusting the rotation display settings of your monitor ...	66
Troubleshooting	67
Self-test.....	67
Built-in diagnostics	68
Common problems	69
Product specific problems	72
Universal Serial Bus (USB) specific problems	73
Regulatory information	74
FCC notices (U.S. only) and other regulatory information	74
EU product database for energy label and product	
information sheet.....	74
Contacting Dell	75



Safety instructions

Use the following safety guidelines to protect your monitor from potential damage and to ensure your personal safety. Unless otherwise noted, each procedure in this document assumes that you have read the safety information that shipped with your monitor.

 **NOTE: Before using the monitor, read the safety information that is shipped with your monitor and printed on the product. Keep the documentation at a secure location for future reference.**

 **WARNING: Use of controls, adjustments, or procedures other than those specified in this documentation may result in exposure to shock, electrical hazards, and/or mechanical hazards.**

 **WARNING: The possible long-term effect of listening to audio at high volume through the headphones (on monitor that support it) may damage your hearing ability.**

- Place the monitor on a solid surface and handle it carefully. The screen is fragile and can be damaged if dropped or pressed with a sharp object.
- Ensure that your monitor is electrically rated to operate with the AC power available in your location.
- Keep the monitor in room temperature. Excessive cold or hot conditions can have an adverse effect on the liquid crystal of the display.
- Connect the power cable from the monitor to a wall outlet that is near and accessible. See [Connecting your monitor](#).
- Do not place and use the monitor on a wet surface or near water.
- Do not subject the monitor to severe vibration or high impact conditions. For example, do not place the monitor inside a car trunk.
- Unplug the monitor when it is going to be left unused for an extended period.
- To avoid electric shock, do not attempt to remove any cover or touch inside the monitor.
- Read these instructions carefully. Keep this document for future reference. Follow all warnings and instructions indicated on product.
- Certain monitors can be wall mounted using the VESA mount that is sold separately. Ensure to use the correct VESA specifications as mentioned in the wall mounting section of the User's Guide.

For information about safety instructions, see the *Safety, Environmental, and Regulatory Information (SERI)* document that is shipped with your monitor.





About your monitor



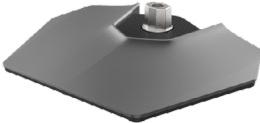

Package contents

The following table provides the list of components that are shipped with your monitor. If any component is missing, contact Dell, see [Contacting Dell](#).

 **NOTE: Some items may be optional and may not ship with your monitor. Some features may not be available in certain countries.**

Component image	Component description
	Display
	Stand riser
	Stand base



Component image	Component description
	Power cable (varies by country)
	DisplayPort cable (1.8 m)
	USB Type-C to DisplayPort cable (1.0 m)
	USB 3.2 Gen1 Type-A to Type-B upstream cable (1.8 m)
	<ul style="list-style-type: none"> • Quick Setup Guide • Safety, Environmental, and Regulatory Information



Product features

The **Dell G2524H** monitor has an active matrix, Thin-Film Transistor (TFT), Liquid Crystal Display (LCD) and LED backlight.

The monitor features include:

- 62.23 cm (24.50 in.) viewable area (measured diagonally) up to 1920 x 1080 resolution through DisplayPort with full screen support or lower resolutions. Supports refresh rate of 240 Hz (280 Hz with Overclock) and up to 1920 x 1080 resolution at 240 Hz through HDMI port.
- NVIDIA G-SYNC Compatible Certification and AMD FreeSync™ Premium Technology and VESA AdaptiveSync Display certification minimizes graphic distortions like screen tearing and stuttering for smoother, fluid gameplay.
- Supports a high refresh rate of 240 Hz and a rapid response time of 1 ms (0.5 ms gray-to-gray min) gray to gray in **Extreme** mode.*
- Color gamut of 99% sRGB.
- Tilt, swivel, pivot, and height adjustment capabilities.
- Digital connectivity with DisplayPort and HDMI.
- Equipped with one SuperSpeed USB 5Gbps (USB 3.2 Gen1) Type-B upstream port, one SuperSpeed USB 5Gbps (USB 3.2 Gen1) Type-A downstream charging port, and one SuperSpeed USB 5Gbps (USB 3.2 Gen1) Type-A downstream port.
- Enabled with gaming console VRR supportability.
- Removable stand and Video Electronics Standards Association (VESA™) 100 mm mounting holes for flexible mounting solutions.
- Plug-and-play capability if supported by your computer.
- On-Screen Display (OSD) adjustments for ease of setup and screen optimization.
- Game enhanced features such as **Timer**, **Frame Rate**, and **Dark Stabilizer** in addition to enhanced game modes such as **FPS**, **MOBA/RTS**, **SPORTS**, or **RPG**, and three additional game modes to personalize your preferences.
- Power and OSD buttons lock.
- Security lock slot.
- Stand lock.
- ≤ 0.3 W in Standby Mode.



- Compatible with Dell Display Manager 2.1 and above.
- The monitor adopts flicker-free technology, which clears the eye visible flicker, brings comfort viewing experience and preventing users suffer from eye strain and fatigue.
- The monitor uses Low Blue Light panel and is in compliance with TUV Rheinland (Hardware Solution) at factory reset or default setting mode (**Preset mode: Standard**).

* 1 ms is achievable in **Extreme** mode to reduce visible motion blur and increased image responsiveness. However, this may introduce some slight and noticeable visual artifacts into the image. As every system setup and every gamer's needs are different, we recommend that users experiment with the different modes to find the setting that is right for them.



Identifying parts and controls

Front view



Label	Description	Use
1	Power On/Off button (with LED indicator)	To turn the monitor on or off. Solid white light indicates that the monitor is turned on and functioning normally. Blinking white light indicates that the monitor is in Standby Mode.

Side view



Back view

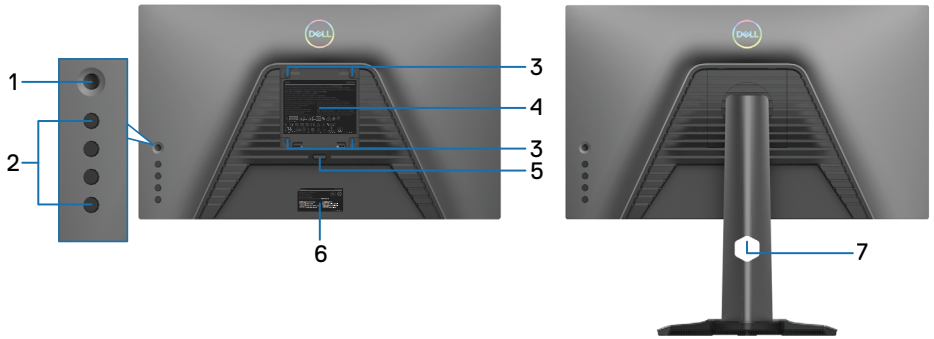

Back view without monitor stand

Back view with monitor stand

Label	Description	Use
1	Joystick	Use it to control the OSD menu. For more information, see Operating the monitor .
2	Function buttons	Press the function buttons to adjust items in the OSD menu. For more information, see Operating the monitor .
3	VESA mounting holes (100 mm x 100 mm - behind attached VESA cover)	Wall-mount the monitor using VESA-compatible wall mount kit (100 mm x 100 mm).
4	Regulatory label	Lists the regulatory approvals.
5	Stand release button	Releases stand from the monitor.
6	Barcode, serial number, and Service Tag label	Refer to this label if you need to contact Dell for technical support. The Service Tag is a unique alphanumeric identifier that enables Dell service technicians to identify the specifications of your monitor and access warranty information.
7	Cable-management slot	Use to organize cables by routing them through the slot.



Bottom view

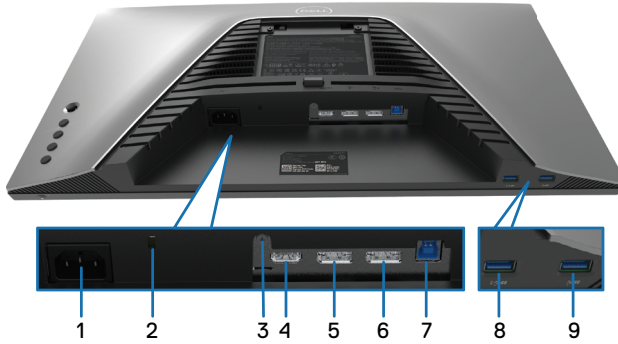

Bottom view without monitor stand

Label	Description	Use
1	Power connector	Connect the power cable (shipped with your monitor).
2	Security lock slot (Based on Kensington Security Slot)	Secure your monitor using a security lock (purchased separately) to prevent unauthorized movement of your monitor. For more information, see Securing your monitor using Kensington lock (optional) .
3	Stand lock	Lock the stand to the monitor using a M3 x 6 mm screw (screw not included).
4	HDMI port	Connect to your computer with the HDMI cable (optional).
5	DisplayPort (1)	Connect to your computer with the DisplayPort cable (shipped with your monitor).
6	DisplayPort (2)	Connect to your computer with the DisplayPort cable (shipped with your monitor).
7	SuperSpeed USB 5Gbps (USB 3.2 Gen1) Type-B upstream port	Connect the USB cable (shipped with your monitor) from this port to your computer to enable the USB ports on your monitor.
8	SuperSpeed USB 5Gbps (USB 3.2 Gen1) Type-A downstream port with Power Charging	Connect the USB cable that comes with your monitor to the computer. Once this cable is connected, you can use the USB downstream connectors on the monitor. Port supports Battery Charging 2 A.
9	SuperSpeed USB 5Gbps (USB 3.2 Gen1) Type-A downstream port	Connect the USB cable that comes with your monitor to the computer. Once this cable is connected, you can use the USB downstream connectors on the monitor. Port supports 0.9 A.



Monitor specifications

Model	G2524H
Screen type	Active matrix - TFT LCD
Panel technology	Fast IPS
Aspect ratio	16:9
Viewable image dimensions	
Diagonal	622.28 mm (24.50 in.)
Width (active area)	543.74 mm (21.41 in.)
Height (active area)	302.62 mm (11.91 in.)
Total area	164545.63 mm ² (255.05 in. ²)
Pixel pitch	0.2832 x 0.2802 mm
Pixel per inch (PPI)	90
Viewing angle	
Vertical	178° (typical)
Horizontal	178° (typical)
Luminance output	400 cd/m ² (typical)
Contrast ratio	1,000 to 1 (typical)
Faceplate coating	Anti-glare treatment of the polarizer (Haze 25%, 3H)
Backlight	White LED edgelight system
Response time	<p>0.5 ms (gray-to-gray min), 1 ms (gray-to-gray most observed) in Extreme Mode*</p> <p>2 ms gray to gray in Super Fast Mode</p> <p>3 ms gray to gray in Fast Mode</p> <p>* 0.5 ms (gray-to-gray min), 1 ms (gray-to-gray most observed) is achievable in Extreme mode to reduce visible motion blur and increased image responsiveness. However, this may introduce some slight and noticeable visual artifacts into the image. As every system setup and every gamer's needs are different, we recommend that users experiment with the different modes to find the setting that is right for them.</p>
Color depth	16.78 million colors
Color gamut	sRGB 99% (typical)



Connectivity	<ul style="list-style-type: none"> • 2 x DP 1.4 (HDCP 1.4)(Supports up to FHD 1920 x 1080 280 Hz, VRR) • 1 x HDMI 2.1 (HDCP 1.4)(Supports up to FHD 1920 x 1080 240 Hz TMDS, VRR as per specified in HDMI 2.1) • 1 x USB 3.2 Gen1 (5Gbps) upstream port • 1 x USB 3.2 Gen1 (5Gbps) downstream port with BC1.2 charging at 2 A (maximum) • 1 x USB 3.2 Gen1 (5Gbps) downstream port
Border width (edge of monitor to active area)	
Top	5.84 mm
Left/Right	5.83 mm
Bottom	18.79 mm
Adjustability	
Height adjustable stand	0 to 130 mm
Tilt	-5° to 21°
Swivel	-45° to 45°
Pivot	-90° to 90°
Dell Display Manager compatibility	Easy Arrange and other key features
Security	Security-lock slot (cable lock sold separately)



Resolution specifications

Model	G2524H
Horizontal scan range	DisplayPort: 30 kHz to 279 kHz (automatic) DisplayPort: 30 kHz to 312 kHz (automatic)(with overclock) HDMI: 30 kHz to 279 kHz (automatic)
Vertical scan range	DisplayPort: 48 Hz to 240 Hz (automatic) DisplayPort: 48 Hz to 280 Hz (automatic)(with overclock) HDMI: 48 Hz to 240 Hz (automatic)
Maximum preset resolution	DisplayPort: 1920 x 1080 at 240 Hz DisplayPort: 1920 x 1080 at 280 Hz (with overclock) HDMI: 1920 x 1080 at 240 Hz

Supported video modes

Model	G2524H
Video display capabilities (HDMI and DisplayPort)	480p at 60 Hz, 576p at 50 Hz, 720p at 50 Hz, 720p at 60 Hz, 1080p at 50 Hz, 1080p at 60 Hz, 1080p at 120 Hz.



Preset display modes

Display mode	Horizontal frequency (kHz)	Vertical frequency (Hz)	Pixel clock (MHz)	Sync polarity (Horizontal/Vertical)
720 x 400	31.50	70.10	28.30	-/+
VESA, 640 x 480	31.50	59.90	25.20	-/-
VESA, 640 x 480	37.50	75.00	31.50	-/-
VESA, 800 x 600	37.90	60.30	40.00	+/+
VESA, 800 x 600	46.90	75.00	49.50	+/+
VESA, 1024 x 768	48.40	60.00	65.00	-/-
VESA, 1024 x 768	60.00	75.00	78.80	+/+
VESA, 1152 x 864	67.50	75.00	108.00	+/+
VESA, 1280 x 1024	64.00	60.00	108.00	+/+
VESA, 1280 x 1024	80.00	75.00	135.00	+/+
VESA, 1600 x 900	60.00	60.00	108.00	+/+
VESA, 1920 x 1080	67.50	60.00	148.50	+/+
1920 x 1080	137.30	120.00	285.50	+/-
1920 x 1080	186.45	165.00	387.81	+/-
1920 x 1080	278.40	240.00	584.60	+/-
1920 x 1080 (Only DP)	285.00	250.00	598.50	+/-
1920 x 1080 (Only DP)	296.40	260.00	622.44	+/-
1920 x 1080 (Only DP)	308.88	270.00	648.648	+/-
1920 x 1080 (Only DP)	311.36	280.00	653.856	+/-



Electrical specifications

Model	G2524H
Video input signals	HDMI/DisplayPort, 600 mV for each differential line, 100 Ω input impedance per differential pair
AC input voltage/frequency/current	100 VAC to 240 VAC / 50 Hz or 60 Hz \pm 3 Hz / 1.50 A (typical)
Inrush current	<ul style="list-style-type: none">· 120 V: 30 A (Max.) at 0°C (cold start)· 240 V: 60 A (Max.) at 0°C (cold start)
Power Consumption	0.2 W (Off mode) ¹ 0.3 W (Standby mode) ¹ 18.5 W (On mode) ¹ 65 W (Max) ² 18.3 W (P _{on}) ³ 57.8 kWh (TEC) ³

¹As defined in EU 2019/2021 and EU 2019/2013

²Max. brightness and contrast setting with maximum power loading on all USB ports.

³ P_{on} : Power consumption of On Mode measured with reference to Energy Star test method.

TEC: Total energy consumption in kWh measured with reference to Energy Star test method.

This document is informational only and reflects laboratory performance. Your product may perform differently, depending on the software, components and peripherals you ordered and shall have no obligation to update such information.

Accordingly, the customer should not rely upon this information in making decisions about electrical tolerances or otherwise. No warranty as to accuracy or completeness is expressed or implied



Physical characteristics

Model	G2524H
Signal cable type	<ul style="list-style-type: none"> • DisplayPort cable (1.8 m) • USB Type-C to DisplayPort cable (1.0 m) • USB 3.2 Gen1 Type-A to Type-B cable (1.8 m)
<p>NOTE: Dell monitors are designed to work optimally with the video cables that are shipped with your monitor. As Dell does not have control over the different cable suppliers in the market, the type of material, connector and process used to manufacture these cables, Dell does not guarantee video performance on cables that are not shipped with your Dell monitor.</p>	
Dimensions (with stand)	
Height (extended)	505.75 mm (19.91 in.)
Height (compressed)	375.75 mm (14.79 in.)
Width	555.40 mm (21.87 in.)
Depth	200.30 mm (7.89 in.)
Dimensions (without stand)	
Height	327.24 mm (12.88 in.)
Width	555.40 mm (21.87 in.)
Depth	65.37 mm (2.57 in.)
Stand dimensions	
Height (extended)	416.90 mm (16.41 in.)
Height (compressed)	369.19 mm (14.54 in.)
Width	275.90 mm (10.86 in.)
Depth	200.30 mm (7.89 in.)
Weight	
Weight with packaging	8.18 kg (18.03 lb)
Weight with stand assembly and cables	5.53 kg (12.19 lb)
Weight without stand assembly (For wall mount or VESA mount considerations - no cables)	3.15 kg (6.94 lb)
Weight of stand assembly	1.98 kg (4.36 lb)



Environmental characteristics

Model	G2524H
Compliant standards	
<ul style="list-style-type: none">· RoHS compliant· BFR/PVC reduce monitor (The circuit boards are made from BFR/PVC-free laminates.)· Arsenic-free glass and Mercury-free for the panel only	
Temperature	
Operating	0°C to 40°C (32°F to 104°F)
Non-operating	<ul style="list-style-type: none">· Storage: -20°C to 60°C (-4°F to 140°F)· Shipping: -20°C to 60°C (-4°F to 140°F)
Humidity	
Operating	10% to 80% (non-condensing)
Non-operating	<ul style="list-style-type: none">· Storage: 5% to 90% (non-condensing)· Shipping: 5% to 90% (non-condensing)
Altitude	
Operating	5,000 m (16,404 ft) (maximum)
Non-operating	12,192 m (40,000 ft) (maximum)
Thermal dissipation	<ul style="list-style-type: none">· 221.8 BTU/hour (maximum)· 63.1 BTU/hour (typical)



Pin assignments

DisplayPort connector

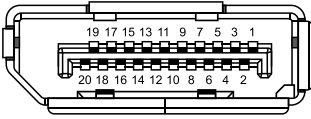

Pin number	20-pin side of the connected signal cable
1	ML3 (n)
2	GND
3	ML3 (p)
4	ML2 (n)
5	GND
6	ML2 (p)
7	ML1 (n)
8	GND
9	ML1 (p)
10	ML0 (n)
11	GND
12	ML0 (p)
13	GND
14	GND
15	AUX (p)
16	GND
17	AUX (n)
18	Hot Plug Detect
19	Re-PWR
20	+3.3 V DP_PWR



HDMI connector

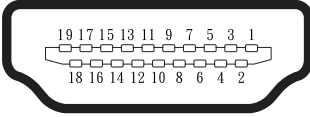

Pin number	19-pin side of the connected signal cable
1	TMDS DATA 2+
2	TMDS DATA 2 SHIELD
3	TMDS DATA 2-
4	TMDS DATA 1+
5	TMDS DATA 1 SHIELD
6	TMDS DATA 1-
7	TMDS DATA 0+
8	TMDS DATA 0 SHIELD
9	TMDS DATA 0-
10	TMDS CLOCK+
11	TMDS CLOCK SHIELD
12	TMDS CLOCK-
13	CEC
14	Reserved (N.C. on device)
15	DDC CLOCK (SCL)
16	DDC DATA (SDA)
17	DDC/CEC Ground
18	+5 V POWER
19	HOT PLUG DETECT



Universal Serial Bus (USB) interface

This section gives you information about the USB ports that are available on the monitor.

NOTE: This monitor is SuperSpeed USB 5Gbps (USB 3.2 Gen1) compatible.

Transfer speed	Data rate	Power consumption*
SuperSpeed	5Gbps	4.5 W (Max, each port)
High speed	480 Mbps	4.5 W (Max, each port)
Full speed	12 Mbps	4.5 W (Max, each port)

*Up to 2 A on USB downstream port (with  battery icon) with battery charging version-compliant devices or normal USB devices.

USB 3.2 Gen1 (5Gbps) upstream connector

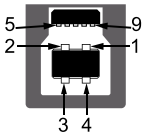

Pin number	9-pin side of the connector
1	VCC
2	D-
3	D+
4	GND
5	SSTX-
6	SSTX+
7	GND
8	SSRX-
9	SSRX+



USB 3.2 Gen1 (5Gbps) downstream connector



Pin number	9-pin side of the connector
1	VCC
2	D-
3	D+
4	GND
5	SSRX-
6	SSRX+
7	GND
8	SSTX-
9	SSTX+

USB ports

- 1 x upstream
- 2 x downstream - Quick Access
Power charging port - the port with  icon; supports up to 2 A fast-charging capability if the device is BC1.2 compatible.

 **NOTE: SuperSpeed USB 5Gbps (USB 3.2 Gen1) functionality requires a SuperSpeed USB 5Gbps (USB 3.2 Gen1)-capable computer.**

 **NOTE: The USB ports on the monitor work only when the monitor is turned on or in Standby mode. If you turn off the monitor and then turn it on, the attached peripherals may take a few seconds to resume normal functionality.**



Plug and play capability

You can install the monitor in any Plug-and-Play-compatible system. The monitor automatically provides the computer system with its Extended Display Identification Data (EDID) using Display Data Channel (DDC) protocols so that the computer can configure itself and optimize the monitor settings. Most monitor installations are automatic; you can select different settings as required. For more information about changing the monitor settings, see [Operating the monitor](#).

LCD monitor quality and pixel policy

During the LCD Monitor manufacturing process, it is not uncommon for one or more pixels to become fixed in an unchanging state which are hard to see and do not affect the display quality or usability. For more information on Dell Monitor Quality and Pixel Policy, see <http://www.dell.com/pixelguidelines>.

Ergonomics

△ CAUTION: Improper or prolonged usage of keyboard may result in injury.

△ CAUTION: Viewing the monitor screen for extended periods of time may result in eye strain.

For comfort and efficiency, observe the following guidelines when setting up and using your computer workstation:

- Position your computer so that the monitor and keyboard are directly in front of you as you work. Special shelves are commercially available to help you correctly position your keyboard.
- To reduce the risk of eye strain and neck, arm, back, or shoulder pain from using the monitor for long periods of time, we recommend you to:
 1. Set the distance of the screen between 20 to 28 in. (50 - 70 cm) from your eyes.
 2. Blink frequently to moisten your eyes or wet your eyes with water after prolonged usage of the monitor.
 3. Take regular and frequent breaks for 20 minutes every two hours.
 4. Look away from your monitor and gaze at a distant object at 20 feet away for at least 20 seconds during the breaks.
 5. Perform stretches to relieve tension in the neck, arm, back, and shoulders during the breaks.
- Ensure that the monitor screen is at eye level or slightly lower when you are sitting in front of the monitor.
- Adjust the tilt of the monitor, its contrast, and brightness settings.



- Adjust the ambient lighting around you (such as overhead lights, desk lamps, and the curtains or blinds on nearby windows) to minimize reflections and glare on the monitor screen.
- Use a chair that provides good lower-back support.
- Keep your forearms horizontal with your wrists in a neutral, comfortable position while using the keyboard or mouse.
- Always leave space to rest your hands while using the keyboard or mouse.
- Let your upper arms rest naturally on both sides.
- Ensure that your feet are resting flat on the floor.
- When sitting, make sure that the weight of your legs is on your feet and not on the front portion of your seat. Adjust your chair's height or use a footrest if necessary to maintain a proper posture.
- Vary your work activities. Try to organize your work so that you do not have to sit and work for extended periods of time. Try to stand or get up and walk around at regular intervals.
- Keep the area under your desk clear of obstructions and cables or power cords that may interfere with comfortable seating or present a potential trip hazard.

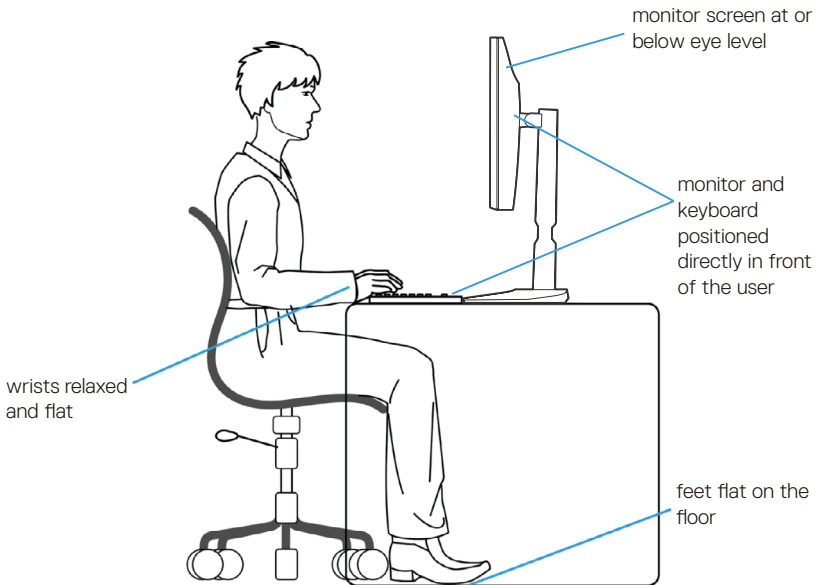

Handling and Moving Your Display

To ensure the monitor is handled safely when lifting or moving it, follow the guidelines mentioned below:

- Before moving or lifting the monitor, turn off your computer and the monitor.
- Disconnect all cables from the monitor.
- Place the monitor in the original box with the original packing materials.
- Hold the bottom edge and the side of the monitor firmly without applying excessive pressure when lifting or moving the monitor.

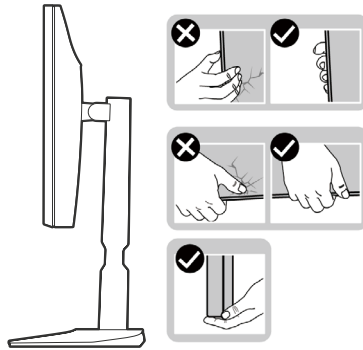

- When lifting or moving the monitor, ensure the screen is facing away from you and do not press on the display area to avoid any scratches or damage.

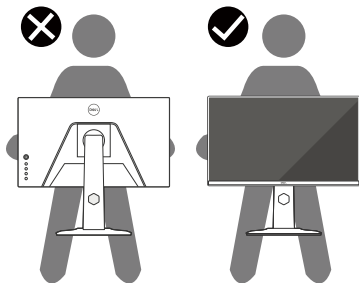

- When transporting the monitor, avoid any sudden shock or vibration to it.



- When lifting or moving the monitor, do not turn the monitor upside down while holding the stand base or stand riser. This may result in accidental damage to the monitor or cause personal injury.

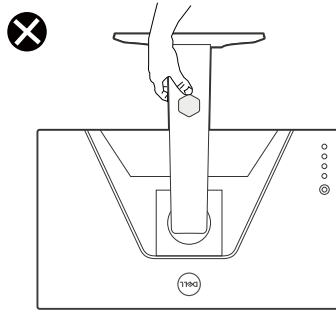

Maintenance guidelines

Cleaning your monitor

⚠ CAUTION: Read and follow the [Safety instructions](#) before cleaning the monitor.

⚠ WARNING: Before cleaning the monitor, unplug the monitor power cable from the electrical outlet.

For best practices, follow the instructions in the list below when unpacking, cleaning, or handling your monitor:

- Use a clean cloth that is slightly dampened with water to clean the stand assembly, the screen, and the chassis of your Dell monitor. If available, use a screen-cleaning tissue or solution suitable for cleaning Dell monitors.
- After cleaning the surface of the table, ensure that it is thoroughly dry and free from any moisture or cleaning agent before placing your Dell monitor on it.

⚠ CAUTION: Do not use detergents or other chemicals such as benzene, thinner, ammonia, abrasive cleaners, alcohol, or compressed air.

⚠ CAUTION: Using chemicals for cleaning may cause changes in the appearance of the monitor, such as color fading, milky film on the monitor, deformation, uneven dark shade, and peeling of screen area.

⚠ WARNING: Do not spray the cleaning solution or even water directly on the surface of the monitor. Doing so will allow liquids to accumulate at the bottom of the display panel and corrode the electronics resulting in permanent damage. Instead, apply the cleaning solution or water to a soft cloth and then clean the monitor.



📌 NOTE: Monitor damage due to improper cleaning methods and the use of benzene, thinner, ammonia, abrasive cleaners, alcohol, compressed air, detergent of any kind will lead to a Customer Induced Damage (CID). CID is not covered under the standard Dell warranty.

- If you notice white residual powder when you unpack your monitor, wipe it off with a cloth.
- Handle your monitor with care as a darker-colored monitor may get scratched and show white scuff marks more than a lighter-colored monitor.
- To help maintain the best image quality on your monitor, use a dynamically changing screen saver and turn off your monitor when not in use.



Setting up the monitor

Attaching the stand

-  **NOTE:** The stand is not installed at the factory when shipped.
-  **NOTE:** The following instructions are applicable only for the stand that was shipped with your monitor. If you are attaching a stand that you purchased from any other source, follow the setup instructions that were included with the stand.

To attach the monitor stand:

1. Follow the instructions on the flaps of carton to remove the stand from the cushion that secures it.
2. Remove the stand base and stand riser from the packaging cushion.

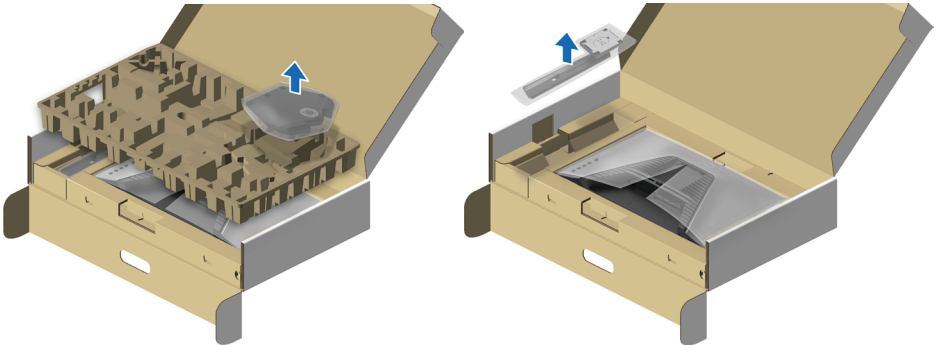

3. Align and place the stand riser on the stand base.
4. Open the screw handle at the bottom of the stand base and turn it clockwise to secure the stand assembly.
5. Close the screw handle.

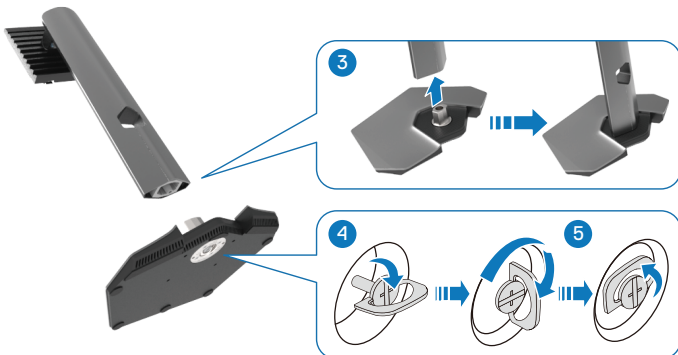

6. Open the protective cover on the monitor to access the VESA slot on the monitor.

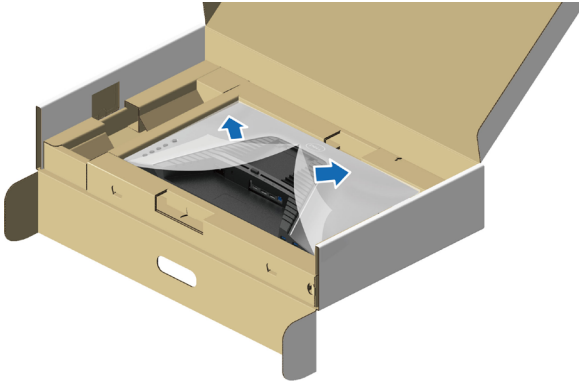

NOTE: Before attaching the stand assembly to the display, ensure that the front plate flap is opened to allow space for assembly.

7. Insert the tabs on the stand riser into the slots on the display back cover and lower the stand assembly to snap it into place.

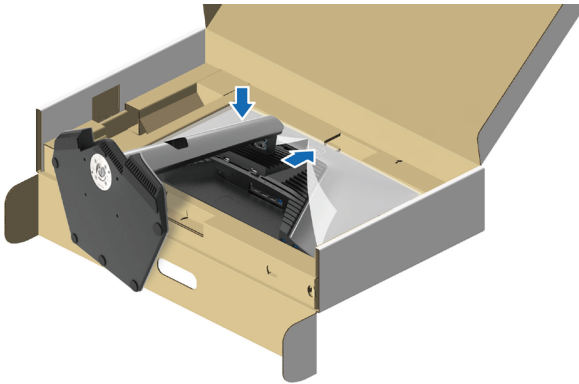

8. Hold the stand riser and lift the monitor carefully, then place it on a flat surface.







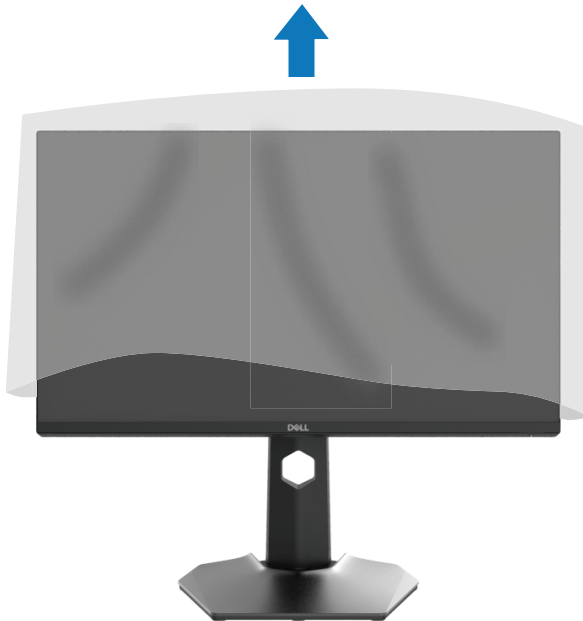

NOTE: Hold the stand riser firmly when lifting the monitor to avoid any accidental damage.

9. Lift the protective cover from the monitor.



Connecting your monitor

-  **WARNING:** Before you begin any of the procedures in this section, follow the [Safety instructions](#).
-  **WARNING:** For your safety, be sure that the grounded power outlet you plug the power cord into easily accessible to operator and located as close to the equipment as possible.
- To disconnect power from the equipment, unplug the power cord from the power outlet by grasping the plug firmly. Never pull on the cord.
-  **WARNING:** A certified power supply cord has to be used with this equipment. The relevant national installation and/or equipment regulations shall be considered. A certified power supply cord not lighter than ordinary polyvinyl chloride flexible cord according to IEC 60227 (designation H05VV-F 3G 0.75mm² or H05VVH2-F2 3G 0.75mm²) shall be used. An alternative flexible cord is synthetic rubber.
-  **NOTE:** Dell monitors are designed to work optimally with Dell-supplied cables inside the box. Dell does not guarantee the video quality and performance if non-Dell cables are used.
-  **NOTE:** Route the cables through the cable-management slot before connecting them.
-  **NOTE:** Do not connect all cables to the computer at the same time.
-  **NOTE:** The images are for the purpose of illustration only. The appearance of the computer may vary.

To connect your monitor to the computer:

1. Turn off your computer and disconnect the power cable.
2. Connect the DisplayPort or HDMI cable from your monitor to the computer.



Connecting the DisplayPort (DP to DP) cable and the power cable

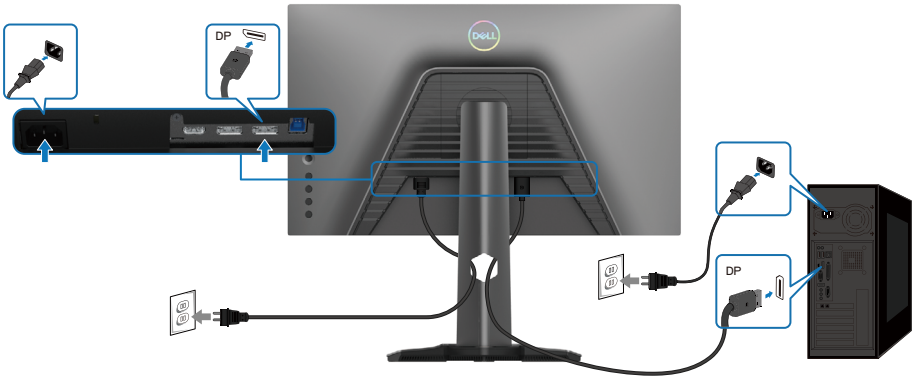

Connecting the USB Type-C to DisplayPort cable and the power cable



Connecting the HDMI cable and the power cable

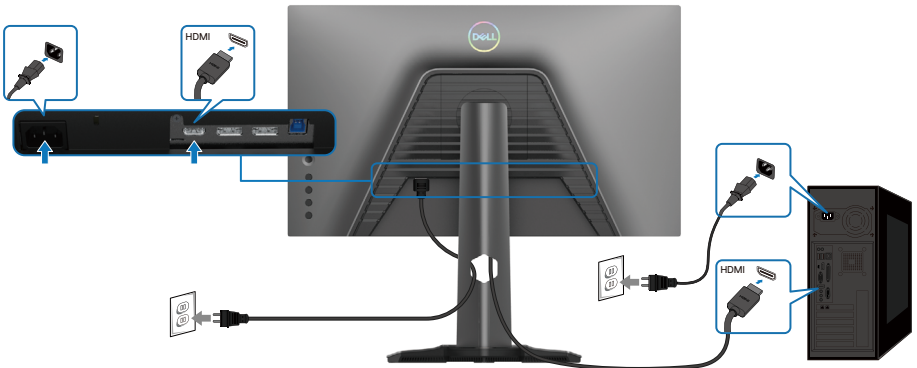

Connecting the SuperSpeed USB 5Gbps (USB 3.2 Gen1) cable and the power cable

After you have completed connecting the DisplayPort/HDMI cable, follow the procedures below to connect the USB cable to the computer and complete your monitor setup:

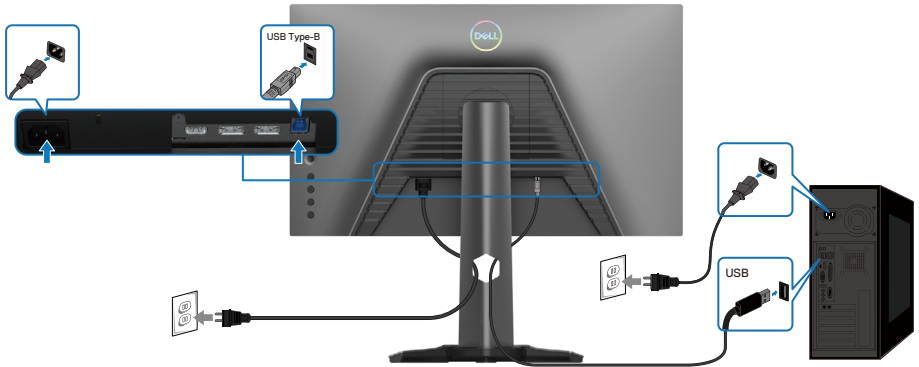

1. Connect the USB 3.2 Gen1 upstream port (cable supplied) to a USB 3.2 Gen1 port on your computer (see **Bottom view** for details).
2. Connect the USB 3.2 Gen1 peripherals to the USB 3.2 Gen1 downstream ports on the monitor.
3. Plug the power cables for your computer and monitor into a nearby outlet.



4. Plug the power cables for your computer and monitor into a wall outlet.

△ CAUTION: Before using the monitor, it is recommended to fasten the stand riser to a wall using cable tie or a cord that can support the weight of the monitor in order to prevent the monitor from falling.

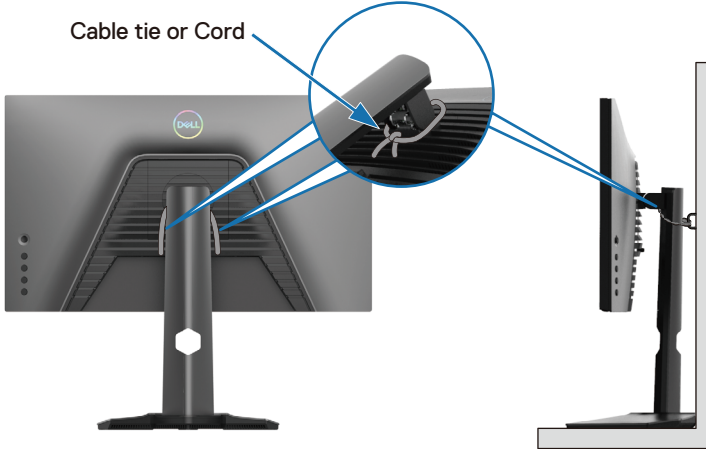

📌 NOTE: Use the cable slot on the monitor stand to organize the cables.

5. Turn on the monitor and the computer.

If your monitor displays an image, the installation is complete. If it does not display any image, see [Common problems](#).



Organizing your cables



After attaching all necessary cables to your monitor and computer, (See [Connecting your monitor](#) for cable attachment) organize all cables as shown above.

If the other end of the cables is unable to reach the computer or a wall outlet, then connect them directly without routing them through the slot on the stand riser.

Securing your monitor using Kensington lock (optional)

The security lock slot is located at the bottom of the monitor (see [Security lock slot](#)). For more information on using the Kensington lock (sold separately), see the documentation that is shipped with the lock. Secure your monitor to a table using the Kensington security lock.

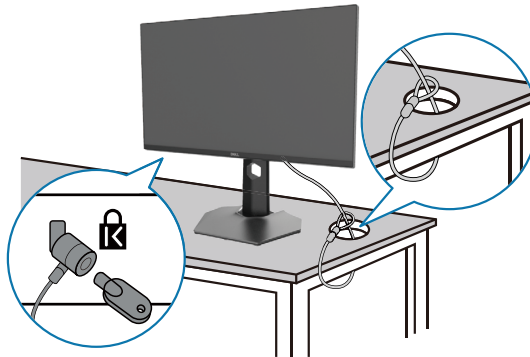

NOTE: The image is for the purpose of illustration only. The appearance of the lock may vary.



Removing the monitor stand

- NOTE:** To prevent scratches on the LCD screen when removing the stand, ensure that the monitor is placed on a soft, clean surface.
- NOTE:** The following instructions are applicable only for the stand that was shipped with your monitor. If you are removing a stand that you purchased from any other source, follow the setup instructions that were included with the stand.

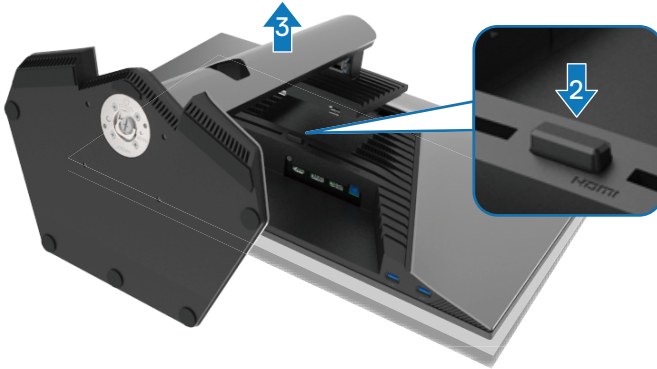

To remove the stand:

1. Place the monitor on a soft cloth or cushion.
2. Press and hold the stand release button.
3. Lift the stand up and away from the monitor.



VESA wall mounting (optional)

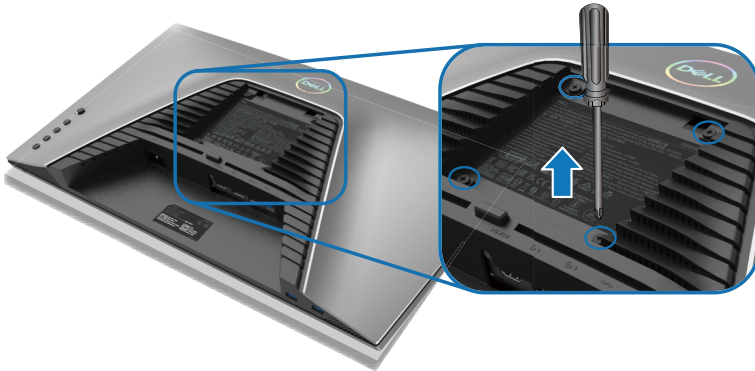

NOTE: Use M4 x 10 mm screws to connect the monitor to the wall-mounting kit.

Refer to the instructions that come with the VESA-compatible wall mounting kit.

1. Place the monitor panel on a soft cloth or cushion on a stable flat table.
2. Remove the stand. For more information, see [Removing the monitor stand](#).
3. Use a Phillips crosshead screwdriver to remove the four screws securing the plastic cover.
4. Attach the mounting bracket from the wall mounting kit to the monitor.
5. Mount the monitor on the wall. For more information, see the documentation that is shipped with the wall mounting kit.

NOTE: For use only with UL or CSA or GS-listed wall mount bracket with minimum weight or load bearing capacity of 12.60 kg (27.77 lb).



Operating the monitor

Power on the monitor

Press the power button to turn on the monitor.

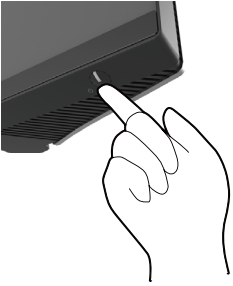

Using the joystick control

Use the joystick control on the rear of the monitor to make OSD adjustments.

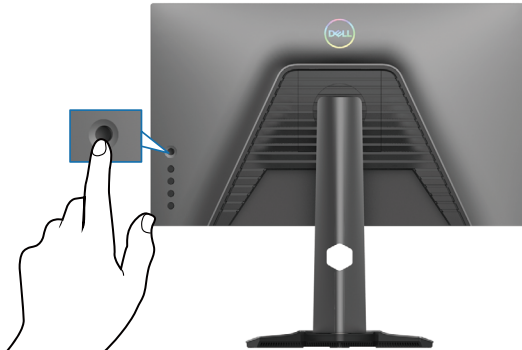

1. Press the joystick button to launch the OSD main menu.
2. Move the joystick up/down/left/right to toggle between options.
3. Press the joystick button again to confirm the settings and exit.



Joystick

Description



- When the OSD menu is on, press the button to confirm the selection or save the settings.
 - When the OSD menu is off, press the button to launch the OSD main menu. See [Accessing the menu system](#).
-





Joystick	Description
	<ul style="list-style-type: none"> For 2-way (right and left) directional navigation. Move right to enter the submenu. Move left to exit from the submenu. Increases (right) or decreases (left) the parameters of the selected menu item.
	<ul style="list-style-type: none"> For 2-way (up and down) directional navigation. Toggles between the menu items. Increases (up) or decreases (down) the parameters of the selected menu item.

Using the rear-panel controls

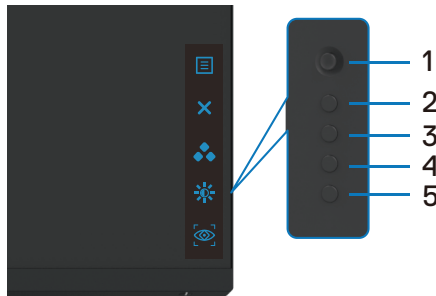

Use the control buttons on the rear of the monitor to access the OSD menu and shortcut keys.



The following table describes the rear-panel buttons:

Rear-panel button	Description
1  Menu	Use the MENU button to launch the On-Screen Display (OSD). For more information, see Accessing the menu system .
2  Exit	To exit the OSD main menu.
3  Shortcut key: Preset Modes	Choose a desired color mode from a list of preset options.



Rear-panel button	Description
<p>4 </p> <p>Shortcut key: Brightness/Contrast</p>	<p>To directly access the Brightness/Contrast adjustment sliders.</p>
<p>5 </p> <p>Shortcut key: Vision Engine</p>	<p>To directly access the Vision Engine adjustment sliders.</p>

When you press any of these buttons (excluding the joystick button), the OSD status bar appears to let you know the current settings of some OSD functions.

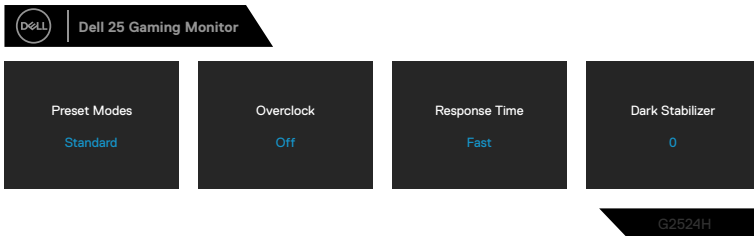

Using the On-Screen Display (OSD) menu

Accessing the menu system

Icon	Menu and Submenus	Description
	<p>Game</p>	<p>Use this menu to personalize your visual gameplay experience.</p>

The screenshot shows the OSD menu system for a Dell 25 Gaming Monitor. The 'Game' menu is selected, showing a list of options: Game, Brightness / Contrast, Input Source, Display, Menu, Personalize, and Others. The 'Game' menu is expanded, showing sub-options: Preset Modes (Standard), Game Enhance Mode (Off), Overclock (Off), Response Time (Fast), Dark Stabilizer (0), Console Mode (Off), Vision Engine (Off), and Hue. A 'G2524H' label is visible in the bottom right corner of the OSD area.



Icon	Menu and Submenus	Description
------	-------------------	-------------

Preset Modes Allows you to choose from a list of preset color modes.

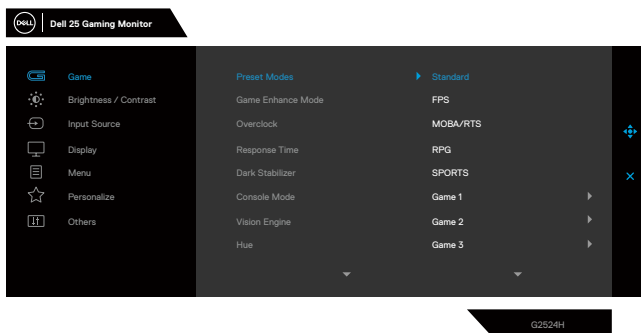

- **Standard:** Loads the monitor's default color settings. This is the default preset mode.
- **FPS:** Loads color settings ideal for First-Person Shooter (FPS) games.
- **MOBA/RTS:** Loads color settings ideal for Multiplayer Online Battle Arena (MOBA) and Real-Time Strategy (RTS) games.
- **RPG:** Loads color settings ideal for Role-Playing Games (RPG).
- **SPORTS:** Loads color settings ideal for sports games.
- **Game 1/Game 2/Game 3:** Allows you to customize the settings such as **color**, **Response Time**, and **Dark Stabilizer** for your gaming needs.

⚠ WARNING: The possible long-term effects of blue light emission from the monitor may cause damage to the eyes, including eye fatigue or digital eye strain. Using monitor for extended periods of time may also cause pain in parts of body such as neck, arm, back and shoulder. For more information, see [Ergonomics](#).





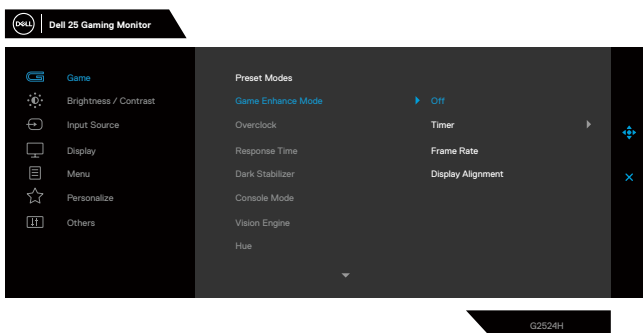

Icon	Menu and Submenus	Description
	Preset Modes	<ul style="list-style-type: none"> • Warm: Presents colors at lower color temperatures. The screen appears warmer with a red/yellow tint. • Cool: Presents colors at higher color temperatures. The screen appears cooler with a blue tint. • Custom Color: Allows you to manually adjust the color settings. Move the joystick to adjust the Gain, Offset, Hue, and Saturation values and create your own preset color mode.

Game Enhance Mode Adjusts Game Enhance Mode to **Off, Timer, Frame Rate** or **Display Alignment**.



- **Off:** Select **Off** to disable the functions under **Game Enhance Mode**.
- **Timer:** Enable or disable the timer at the top-left corner of the display. The timer shows the time elapsed since the game starts. Select an option from the time-interval list to keep you aware of the remaining time.
- **Frame Rate:** Select to display the current frames per second when playing games. The higher the rate, the smoother the motion appears.
- **Display Alignment:** Activating the function may help ensure the perfect alignment of the video contents from multiple displays.

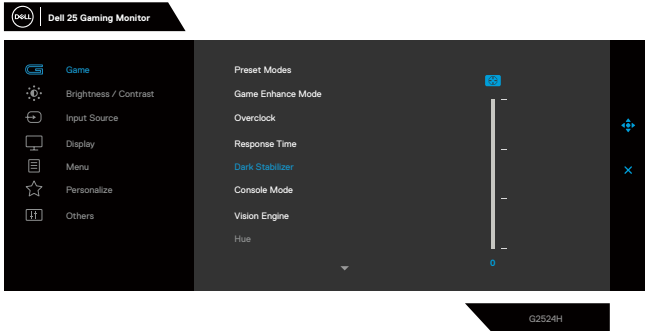

Icon	Menu and Submenus	Description
Overclock	<p>Allows you to operate the monitor at a higher refresh rate than specified by the panel specification.</p> <p>Overclock has four options: 250 Hz, 260 Hz, 270 Hz, and 280 Hz.</p> <p> NOTE: This function is available only when using DP (DisplayPort) input.</p> <p> NOTE: Overclocking may cause screen flickering or abnormal display. To reduce such effects, select “Off” in the Overclock menu.</p>	
Response Time	<p>Allows you to set the Response Time to Fast, Super Fast, or Extreme.</p>	
Dark Stabilizer	<p>Improves the visibility in the dark gaming scenarios. The higher the value (0 to 3), the more visible the display image will be in dark environment.</p>	
		
Console Mode	<p>Adjusts Console Mode to On/Off, Color, or Gamma. Activating this feature gives the best gaming experience when playing console games.</p> <ul style="list-style-type: none"> • On/Off: Select to enable/disable functions under Console Mode. • Color: RGB default 100, and this mode can adjust RGB from 0~100. • Gamma: Gamma default is at center 2.2. Selecting this feature enables you to manually adjust Gamma from 1.8~2.6. <p> NOTE: Preset modes are not available when Console mode is turned to “On”.</p>	



Icon	Menu and Submenus	Description
	Vision Engine	<p>Adjusts Vision Engine to On/Off, Night vision, Clear vision, Chroma vision, or Crosshair, and this feature improves the visibility in gaming scenarios. For more information, see Vision Engine.</p> <ul style="list-style-type: none"> • On/Off: Select to enable/disable functions under Vision Engine. • Night Vision: Uses this feature when playing games to identify objects clearly, enhance contents in darkness. • Clear Vision: This feature is suitable to clean up visual artifacts, enhance content details such as sharpness, edges, super-resolutions, in a day scene. • Chroma Vision: This feature can apply heatmap in dark gaming scenarios. • Crosshair: This feature enhances the visibility of in-game crosshair.

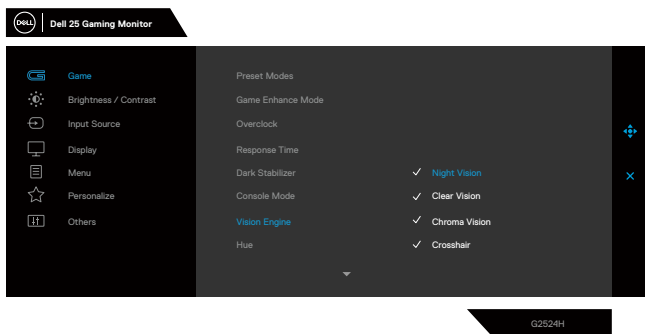

NOTE: FPS and Timer counters are not available in Crosshair.

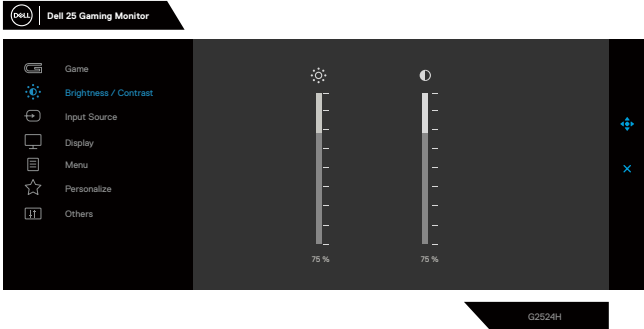

Icon	Menu and Submenus	Description
	Hue	<p>This feature can shift the color of the video image to green or purple. This is used to adjust the desired flesh-tone color.</p> <p>Use the joystick to adjust the hue level from 0 to 100.</p> <p>Move the joystick up to increase the green shade of the video image.</p> <p>Move the joystick down to increase the purple shade of the video image.</p> <p>NOTE: The Hue adjustment is available only when you select FPS, MOBA/RTS, SPORTS, or RPG preset mode.</p>
	Saturation	<p>This feature can adjust the color saturation of the video image.</p> <p>Use the joystick to adjust the saturation level from 0 to 100.</p> <p>Move the joystick up to increase the colorful appearance of the video image.</p> <p>Move the joystick down to increase the monochrome appearance of the video image.</p> <p>NOTE: The Saturation adjustment is available only when you select FPS, MOBA/RTS, SPORTS, or RPG preset mode.</p>
	Reset Game	<p>Resets all settings under the Game menu to the factory defaults.</p>
	Brightness/ Contrast	<p>Adjusts the brightness and contrast of the display.</p>
		



Icon	Menu and Submenus	Description
	Brightness	Brightness adjusts the luminance of the backlight (minimum 0; maximum 100). Move the joystick up to increase the brightness level or move the joystick down to decrease the brightness level.
	Contrast	Adjusts the Brightness first, and then adjust the Contrast only if further adjustment is necessary. Move the joystick Up to increase the contrast level or move the joystick Down to decrease the contrast level (Range: 0 - 100). The Contrast function adjusts the degree of difference between darkness and lightness on the monitor screen.



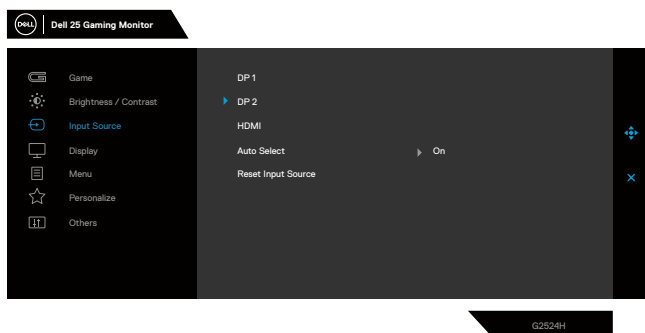

Input Source

Selects between different video signals that may be connected to your monitor.



DP 1	Select the DP 1 or DP 2 input when you are using the DP (DisplayPort) connector. Press the joystick button to confirm the selection.
DP 2	Select the DP 1 or DP 2 input when you are using the DP (DisplayPort) connector. Press the joystick button to confirm the selection.
HDMI	Select the HDMI input when you are using the HDMI connector. Press the joystick button to confirm the selection.
Auto Select	Turn on the function to allow the monitor to automatically scan for available input sources. Press the joystick button to confirm the selection.
Reset Input Source	Resets your monitor's Input Source settings to the factory defaults.

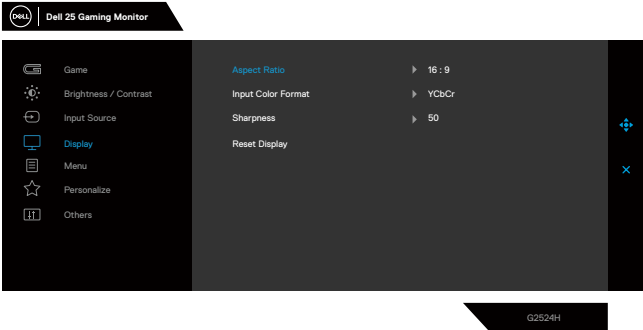

Icon	Menu and Submenus	Description
	Display	Use the Display menu to adjust images. 
Aspect Ratio		Adjust the ratio of width to height of an image to 16:9 , 4:3 , or 5:4 .
Input Color Format		Allows you to set the video input mode to: <ul style="list-style-type: none"> • RGB: Select this option if your monitor is connected to a computer or a media player that supports RGB output. • YCbCr: Select this option if your media player supports only YCbCr output.
Sharpness		This feature can make the image look sharper or softer. Move the joystick to adjust the sharpness level from 0 to 100.
Reset Display		Resets all settings under the Display menu to the factory defaults.
	Menu	Select this option to adjust the settings of the OSD, such as the languages of the OSD, the amount of time the menu remains on screen, and so on. 



Icon	Menu and Submenus	Description
	Language	Set the OSD display to one of the eight languages (English, Spanish, French, German, Brazilian Portuguese, Russian, Simplified Chinese, or Japanese).
	Transparency	Select this option to change the menu transparency by moving the joystick up or down (minimum 0; maximum 100).
	Timer	Sets the length of time for the OSD to remain active after you move the joystick or press a button. Move the joystick to adjust the slider in 1 second increment, from 5 to 60 seconds.
	Reset Menu	Resets all settings under the Menu menu to the factory defaults.



Personalize

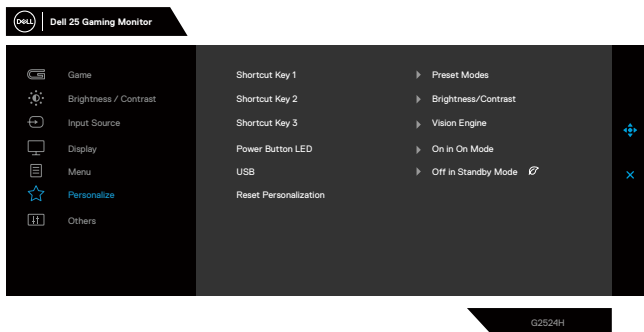

Shortcut Key 1	Allows you to choose a feature from Preset Modes, Game Enhance Mode, Overclock, Dark Stabilizer, Vision Engine, Brightness/Contrast, Input Source, or Aspect Ratio , and set it as a shortcut key.
Shortcut Key 2	
Shortcut Key 3	
Power Button LED	Allows you to select On in On Mode, Off in On Mode or Off in On/Standby Mode to set the power LED indicator to save energy.



Icon	Menu and Submenus	Description
------	-------------------	-------------

USB

Allows you to enable or disable USB function during monitor standby mode.

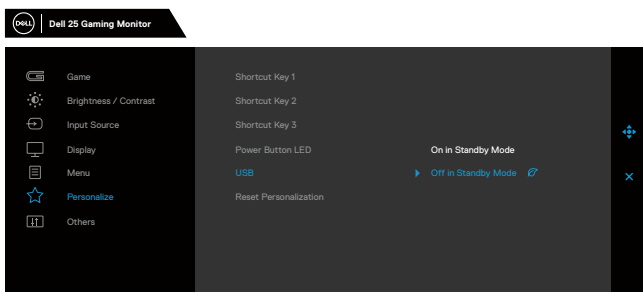

G2524H

NOTE: USB On/Off under standby mode is only available when the USB upstream cable is unplugged. This option will be greyed out when the USB upstream cable plugged in.

Reset Personalization

Resets all settings under the **Personalize** menu to the factory preset values.



Others

Select this option to adjust the OSD settings, such as **DDC/CI**, **LCD Conditioning**, and so on.

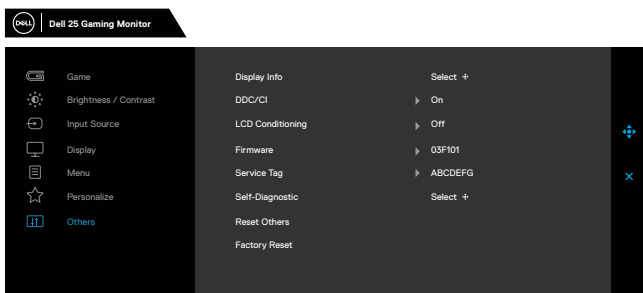

G2524H

Display Info

Displays the monitor's current settings.



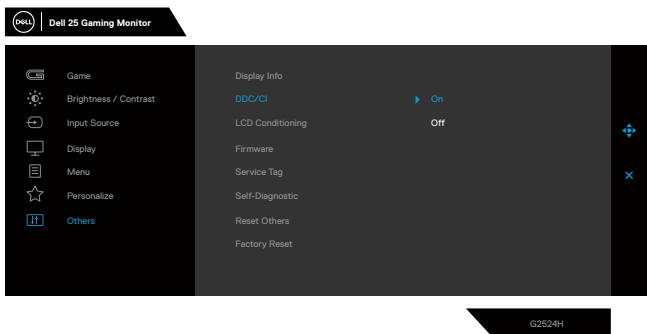

Icon	Menu and Submenus	Description
DDC/CI	<p>DDC/CI (Display Data Channel/Command Interface) allows you to adjust features such as brightness and color balance of your monitor using software installed on your computer. You can disable this feature by selecting Off. Enable this feature for best user experience and optimum performance of your monitor.</p>	

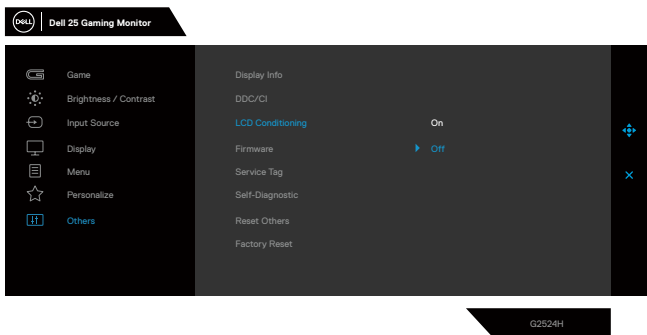

LCD Conditioning

Helps reduce minor cases of image retention. Depending on the degree of image retention, the program may take some time to run. You can enable this feature by selecting **On**.



Icon	Menu and Submenus	Description
	Firmware	Displays the firmware version of your monitor.
	Service Tag	Displays the service tag of your monitor. The Service Tag is a unique alphanumeric identifier that allows Dell to identify the product specifications and access warranty information.  Note: The Service Tag is also printed on a label located at the back of the cover.
	Self-Diagnostic	Use this option to run the built-in diagnostics, For more information see, Built-in diagnostics .
	Reset Others	Resets all settings under the Others menu to the factory defaults.
	Factory Reset	Restores all preset values to the factory default settings.



Vision Engine

Vision Engine has special vision engine design that can enhance visual elements in different gaming scenes, including four visions: **Night vision**, **Clear vision**, **Chroma vision**, or **Crosshair** engines for you to select. Trigger using the OSD or Dell Display Manager to set them up, and trigger from the Shortcut key.

Use the OSD menu and Shortcut key to launch Vision Engine:

1. Press the Joystick button to launch the OSD Main Menu.
2. Move the Joystick button to select **Game > Vision Engine** to initiate it.
3. Select **On** or **Off** to decide whether to enable the functions in Vision Engine mode.

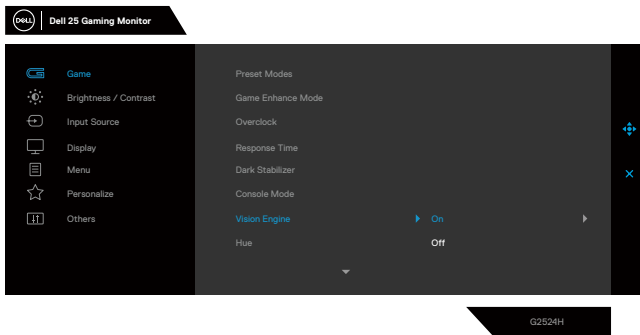

The following message appears when you select “On”, and you can preview the effect of each vision by moving Joystick button.

NOTE: Press Joystick button to check/uncheck the vision engines. By default, all vision engines are checked. You can check the vision engines according to your preference.

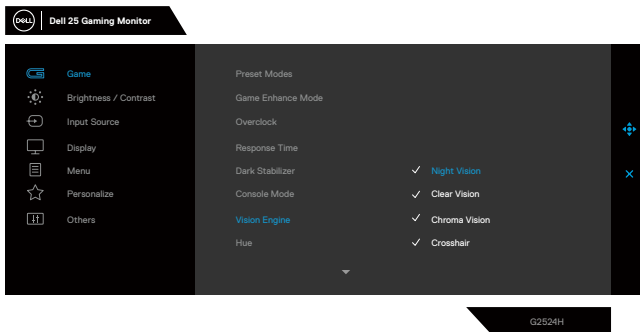

4. Use the **Shortcut Key of Vision Engine** to toggle different vision engines.



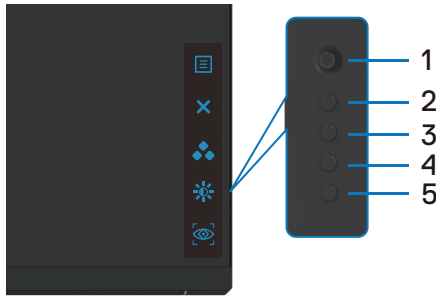

NOTE: Adjust the preset Shortcut keys in Personalize settings.

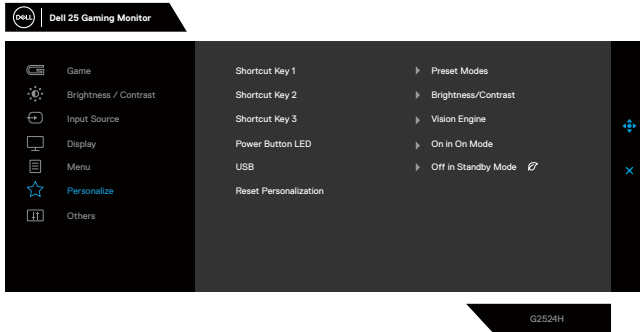

Use the Dell Display Manager and Shortcut key to launch Vision Engine:

1. Press the Joystick button to launch the OSD Main Menu.
2. Move the Joystick button to select **Game > Vision Engine** to initiate it.
3. Select **On** to enable the functions in Vision Engine mode.

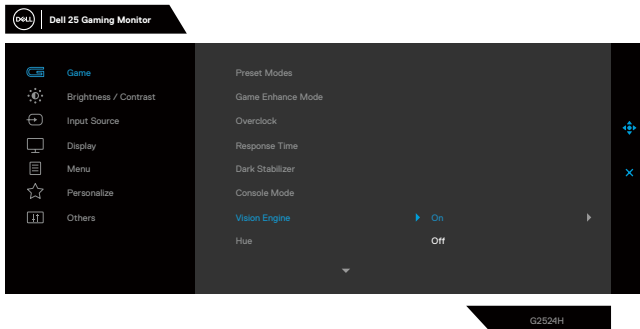

4. Alternatively, Vision Engine settings can be set in Dell Display Manager (Dell Display Manager installed for better gaming experiences). For more information, see Dell Display Manager installation section at www.dell.com/G2524H.



OSD warning message

When the monitor does not support a particular resolution mode, you can see the following message:

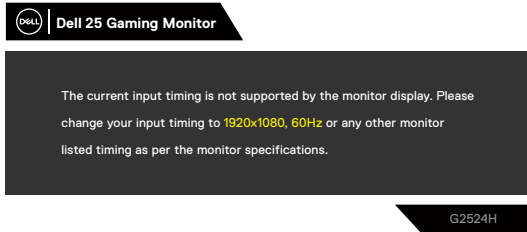

This means that the monitor cannot synchronize with the signal that it is receiving from the computer. See [Monitor specifications](#) for the Horizontal and Vertical frequency ranges addressable by this monitor. Recommended mode is 1920 x 1080.

NOTE: The message that appears on the monitor varies based on the type of input cable used.

You can see the following message before the DDC/CI function is disabled:

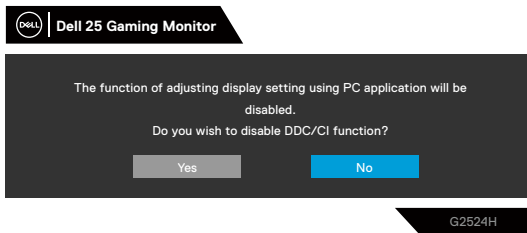

When the monitor enters the **Standby mode**, the following message will appear:

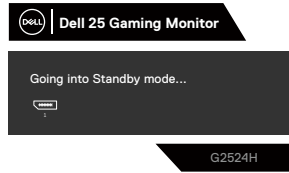

Activate the computer and wake up the monitor to gain access to the **OSD**.

When you increase the **Brightness** level above the factory default setting for the first time, the following message appears:

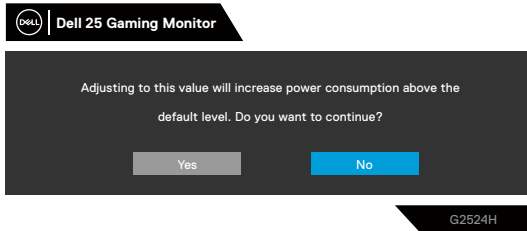

If you press any button other than the power button, the following messages appear depending on the selected input:

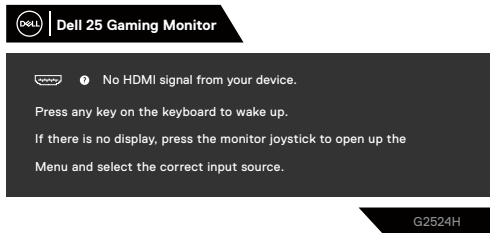

If either HDMI, DP1 and DP2 input is selected and the corresponding cable is not connected, a floating dialog box as shown below appears:

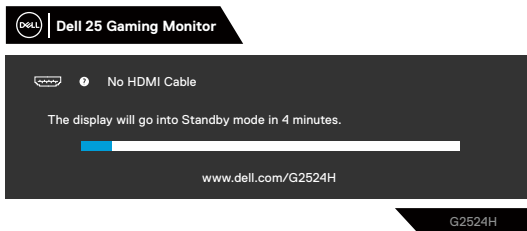

or



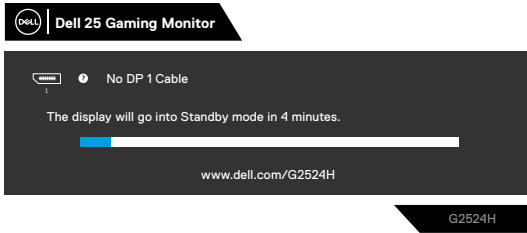

or

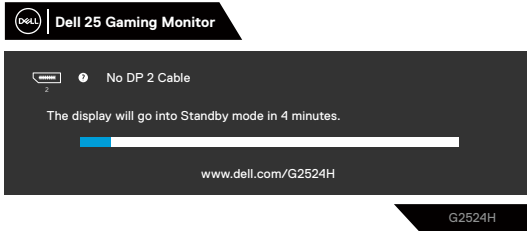

When you select OSD items of **Factory Reset** in **Other** feature, the following message will appear:

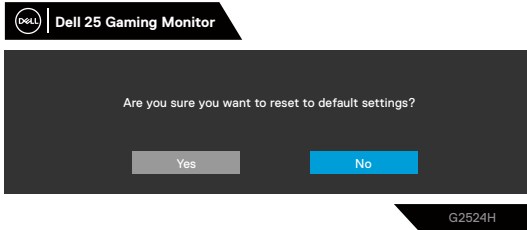

For more information, see [Troubleshooting](#).



Locking the rear-panel control buttons

You can lock the rear-panel control buttons to prevent access to the OSD menu and/or power button.

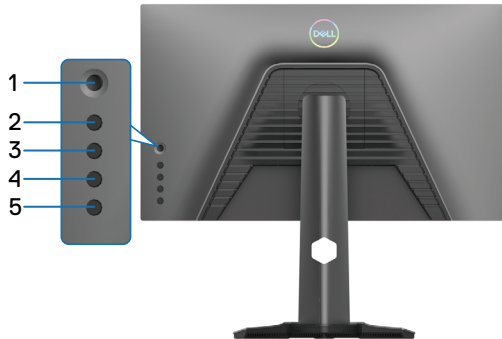

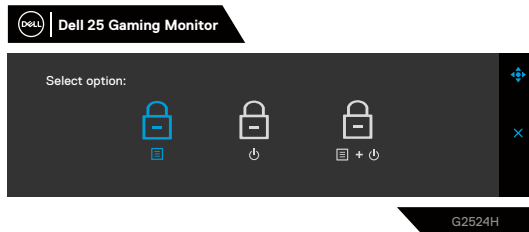

To lock the button(s).

Press and hold **Button 5** for four seconds, a menu appears on the screen.



Select one of the following options:

Options	Description
1  Menu Button Lock	Select this option to lock OSD menu function.
2  Power Button Lock	Use this option to lock power button. This will prevent the user to turn off the monitor using the power button.
3  Menu and Power Button Lock	Use this option to lock OSD menu and power button to turn off the monitor.



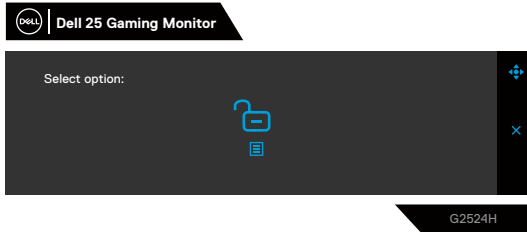

To unlock the button(s).

Press and hold **Button 5** for four seconds until a menu appears on the screen. Select the **Unlock icon**  to unlock the button(s).



Select one of the following options:

	Options	Description
1	 Menu Button Unlock	Use this option to unlock OSD menu function.
2	 Power Button Unlock	Use this option to unlock power button.
3	 Menu and Power Button Unlock	Use this option to unlock OSD menu and power button to turn off the monitor.



Setting the maximum resolution

 **NOTE: The steps may vary slightly depending on the version of Windows you have.**

To set the maximum resolution for the monitor:

In Windows 10 and Windows 11:

1. Right-click on the desktop and click **Display settings**.
2. If you have more than one monitor connected, ensure to select **G2524H**.
3. Click the **Display Resolution** dropdown list and select **1920 x 1080**.
4. Click **Keep changes**.

If you do not see 1920 x 1080 as an option, you must update your graphics driver to the latest version. Depending on your computer, complete one of the following procedures:

If you have a Dell desktop or laptop:

- Go to <https://www.dell.com/support>, enter your service tag, and download the latest driver for your graphics card.

If you are using a non-Dell computer (laptop or desktop):

- Go to the support site for your non-Dell computer and download the latest graphic drivers.
- Go to your graphics card's website and download the latest graphic drivers.



Setting the maximum frame rate

 **NOTE: The steps may vary slightly depending on the version of Windows you have.**

To set the maximum frame rate for the monitor:

In Windows 10:

1. Right-click on the desktop and click **Display settings**.
2. Click **Advanced display settings**.
3. If you have more than one monitor connected, ensure to select **G2524H**.
4. Click the **Display adapter properties** link.
5. Click the **Monitor** tab.
6. Select **240 Hertz** from the **Screen refresh rate** dropdown list.
7. Click **OK**.

In Windows 11:

1. Right-click on the desktop and click **Display settings**.
2. Click **Advanced display**.
3. If you have more than one monitor connected, ensure to select **G2524H**.
4. Select **240 Hertz** from the **Choose a refresh rate** dropdown list.
5. Click **Keep changes**.



Using the tilt and vertical extension

NOTE: The following instructions are applicable only for the stand that was shipped with your monitor. If you are connecting a stand that you purchased from any other source, follow the set up instructions that were included with the stand.

Tilt and swivel extensions

With the stand attached to the monitor, you can tilt and swivel the monitor for the most comfortable viewing angle.

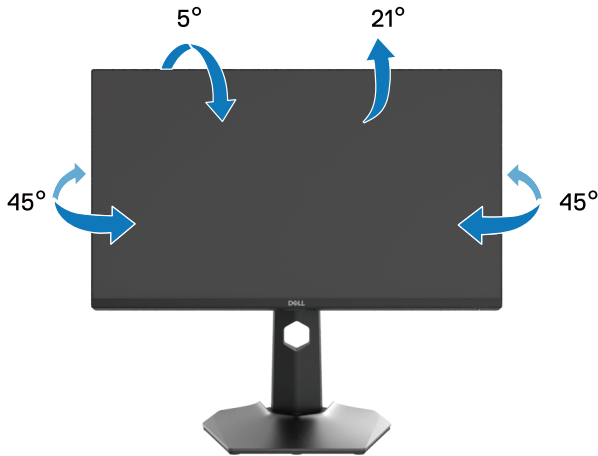

NOTE: The stand is not installed at the factory when shipped.



Vertical extension

NOTE: The stand extends vertically up to 130 mm. The figure below illustrates how to extend the stand vertically.

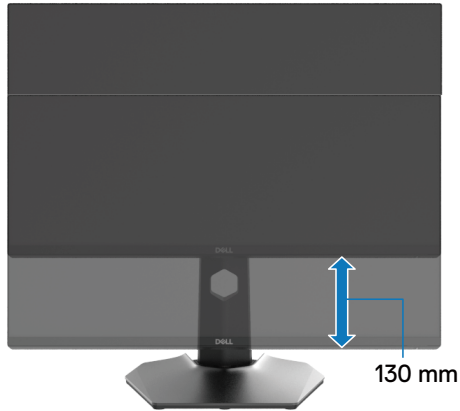

Rotating the display

Before you rotate the display, ensure it is completely extended vertically and completely tilted up, to avoid hitting the bottom edge of the monitor.

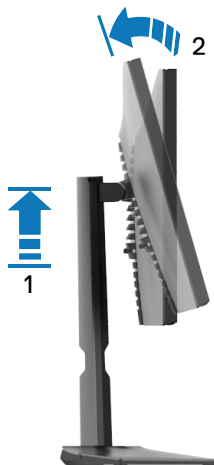



Rotate clockwise



Rotate counterclockwise



-  **NOTE:** To use the Display Rotation function (Landscape versus Portrait view) with your Dell computer, you require an updated graphics driver that is not included with this monitor. To download the graphics driver, go to www.dell.com/support.
-  **NOTE:** In the Portrait mode, you may experience performance degradation when using graphic-intensive applications such as 3D gaming.



Adjusting the rotation display settings of your monitor

After you have rotated your monitor, you need to complete the procedure below to adjust the Rotation Display Settings of your monitor.

 **NOTE: If you are using the monitor with a non-Dell computer, you need to go the graphics driver website or your computer manufacturer website for information on rotating the 'contents' on your display.**

To adjust the Rotation Display Settings:

1. Right-click on the desktop and click **Properties**.
2. Select the **Settings** tab and click **Advanced**.
3. If you have an ATI graphics card, select the **Rotation** tab and set the preferred rotation.
4. If you have an NVIDIA graphics card, click the **NVIDIA** tab, in the left column select **NVRotate**, and then select the preferred rotation.
5. If you have an Intel graphics card, select the **Intel** graphics tab, click **Graphic Properties**, select the **Rotation** tab, and then set the preferred rotation.

 **NOTE: If you do not see the rotation option or it is not working correctly, go to www.dell.com/support and download the latest driver for your graphics card.**



Troubleshooting

⚠ WARNING: Before you begin any of the procedures in this section, follow the [Safety instructions](#).

Self-test

Your monitor provides a self-test feature that allows you to check whether your monitor is functioning properly. If your monitor and computer are properly connected but the monitor screen remains dark, run the monitor self-test by performing the following steps:

1. Turn off both your computer and the monitor.
2. Unplug the video cable from the back of the computer. To ensure proper self-test operation, remove all digital cables from the back of computer.
3. Turn on the monitor.

✎ NOTE: A dialog box should appear on-screen (against a black background), if the monitor cannot sense a video signal and is working correctly. While in self-test mode, the power LED remains white (default color).

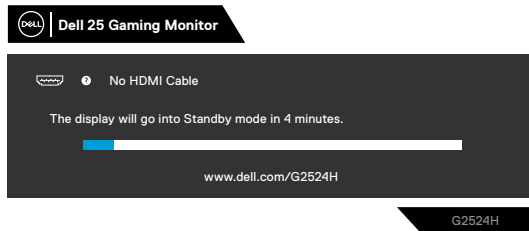

✎ NOTE: The message may slightly differ, depending on the connected input signal.

4. This box also appears during normal system operation, if the video cable becomes disconnected or damaged.
5. Turn off your monitor and reconnect the video cable; then turn on both your computer and the monitor.

If your monitor screen remains blank after you perform the previous procedure, check your video controller and computer, because your monitor is functioning properly.



Built-in diagnostics

Your monitor has a built-in diagnostic tool that helps you determine if the screen abnormality you are experiencing is an inherent problem with your monitor, or with your computer and video card.

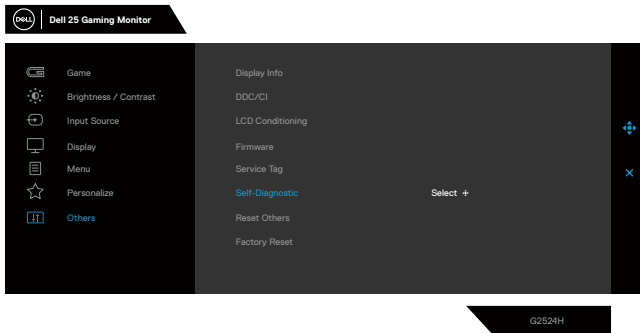

To run the built-in diagnostics:

1. Ensure that the screen is clean (no dust particles on the surface of the screen).
2. Select OSD items of Self-Diagnostic in **Others** feature.
3. Press the Joystick button to start the diagnostics. A gray screen is displayed.
4. Observe if the screen has any defects or abnormalities.
5. Toggle the joystick once again until a red screen is displayed.
6. Observe if the screen has any defects or abnormalities.
7. Repeat steps 5 and 6 until the screen displays green, blue, black, and white colors. Note any abnormalities or defects.

If you do not detect any screen abnormalities upon using the built-in diagnostic tool, the monitor is functioning properly. Check the graphics card and computer.

The test is complete when a text screen is displayed. To exit, toggle the joystick control again.



Common problems

The following table provides general information about common monitor problems you might encounter and the possible solutions:

Common symptoms	What you experience	Possible solutions
No video/ Power LED off	No picture	<ul style="list-style-type: none">• Ensure that the video cable connecting the monitor and the computer is properly connected and secure.• Verify that the power outlet is functioning properly using any other electrical equipment.• Ensure that the power button is pressed.• Ensure that the correct input source is selected in the Input Source menu.
No video/ Power LED on	No picture or no brightness	<ul style="list-style-type: none">• Increase the brightness and contrast controls using OSD.• Invoke the self-test feature (see Self-test).• Check for bent or broken pins in the video cable connector.• Run the built-in diagnostics.• Ensure that the correct input source is selected in the Input Source menu.
Poor focus	Picture is fuzzy, blurry, or ghosting	<ul style="list-style-type: none">• Eliminate video extension cables.• Reset the monitor to factory settings.• Change the video resolution to the correct aspect ratio.
Shaky/Jittery video	Wavy picture or fine movement	<ul style="list-style-type: none">• Reset the monitor to factory settings.• Check environmental factors.• Relocate the monitor and test it in another room.
Missing pixels	LCD screen has spots	<ul style="list-style-type: none">• Turn off the monitor and turn it on again.• Pixel that is permanently off is a natural defect that can occur in LCD technology.• For more information on Dell Monitor Quality and Pixel Policy, see Dell Support site at: www.dell.com/pixelguidelines



Common symptoms	What you experience	Possible solutions
Stuck-on pixels	LCD screen has bright spots	<ul style="list-style-type: none"> • Turn off the monitor and turn it on again. • Pixel that is permanently off is a natural defect that can occur in LCD technology. • For more information on Dell Monitor Quality and Pixel Policy, see Dell Support site at: www.dell.com/pixelguidelines
Brightness problems	Picture too dim or too bright	<ul style="list-style-type: none"> • Reset the monitor to factory settings. • Adjust brightness and contrast controls using OSD.
Geometric distortion	Screen not centered correctly	Reset the monitor to factory settings.
Horizontal/ Vertical lines	Screen has one or more lines	<ul style="list-style-type: none"> • Reset the monitor to factory settings. • Invoke the self-test feature (see Self-test) and determine if these lines are also flagged in the self-test mode. • Check for bent or broken pins in the video cable connector. • Run the built-in diagnostics.
Synchronization problems	Screen is scrambled or appears torn	<ul style="list-style-type: none"> • Reset the monitor to factory settings. • Invoke the self-test feature (see Self-test) and determine if these lines are also flagged in the self-test mode. • Check for bent or broken pins in the video cable connector. • Restart the computer in the safe mode.
Safety related issues	Visible signs of smoke or sparks	<ul style="list-style-type: none"> • Do not perform any troubleshooting steps. • Contact Dell immediately.
Intermittent problems	Monitor malfunctions on and off	<ul style="list-style-type: none"> • Ensure that the video cable connecting the monitor to the computer is connected properly and is secure. • Reset the monitor to factory settings. • Invoke the self-test feature (see Self-test) to determine if the intermittent problem is flagged in the self-test mode.



Common symptoms	What you experience	Possible solutions
Missing color	Picture missing color	<ul style="list-style-type: none"> · Perform monitor self-test feature check. · Ensure that the video cable connecting the monitor to the computer is connected properly and is secure. · Check for bent or broken pins in the video cable connector.
Wrong color	Picture color not good	<ul style="list-style-type: none"> · Change the settings of the Preset Modes in the Game menu OSD depending on the application. · Adjust the Gain/Offset/Hue/Saturation values under Custom Color in the Game menu OSD. · Change the Input Color Format to RGB or YCbCr/YPbPr in the Display settings OSD. · Run the built-in diagnostics.
Image retention from a static image left on the monitor for a long period of time	Faint shadow from the static image displayed appears on the screen	<ul style="list-style-type: none"> · Set the screen to turn off after a few minutes of screen idle time. These can be adjusted in Windows Power Options or Mac Energy Saver setting. · Alternatively, use a dynamically changing screensaver.



Product specific problems

Common Symptoms	What you experience	Possible Solutions
Screen image is too small	Image is centered on screen, but does not fill entire viewing area	<ul style="list-style-type: none">• Check the Aspect Ratio setting in the Display menu OSD.• Reset the monitor to factory settings.
Cannot adjust the monitor with the buttons on the rear panel	OSD does not appear on the screen	<ul style="list-style-type: none">• Turn Off the monitor, unplug the power cord, plug it back, and then turn On the monitor.• The OSD menu may be locked. Press and hold the fourth button (the Brightness/Contrast shortcut key by default) below the joystick button for 4 seconds to unlock.
No input signal when user controls are pressed	No picture, the LED light is white	<ul style="list-style-type: none">• Check the signal source. Ensure the computer is not in the power saving mode by moving the mouse or pressing any key on the keyboard.• Check whether the signal cable is plugged in properly. Re-plug the signal cable if necessary.• Reset the computer or video player.
The picture does not fill the entire screen	The picture cannot fill the height or width of the screen	<ul style="list-style-type: none">• Due to different video formats (aspect ratio) of DVDs, the monitor may display in full screen.• Run the built-in diagnostics.



Universal Serial Bus (USB) specific problems

Common Symptoms	What you experience	Possible Solutions
USB interface is not working	USB peripherals are not working	<ul style="list-style-type: none">• Check that your monitor is turned On.• Reconnect the upstream cable to your computer.• Reconnect the USB peripherals (downstream connector).• Turn off your monitor and turn it on again.• Restart your computer.• Certain USB devices such as portable hard drives require higher power source; connect the drive to the computer directly.
SuperSpeed USB 5Gbps (USB 3.2 Gen1) interface is slow	SuperSpeed USB 5Gbps (USB 3.2 Gen1) peripherals working slowly or not working at all	<ul style="list-style-type: none">• Check that your computer is SuperSpeed USB 5Gbps (USB 3.2Gen1)-compatible.• Some computers have USB 3.2, USB 2.0, and USB 1.1 ports. Ensure that the correct USB port is used.• Reconnect the upstream cable to your computer.• Reconnect the USB peripherals (downstream connector).• Restart your computer.
Wireless USB peripherals stop working when a USB 3.2 device is plugged in	Wireless USB peripherals responding slowly or only working as the distance between itself and its receiver decreases	<ul style="list-style-type: none">• Increase the distance between the USB 3.2 peripherals and the wireless USB receiver.• Position your wireless USB receiver as close as possible to the wireless USB peripherals.• Use a USB-extender cable to position the wireless USB receiver as far away as possible from the USB 3.2 port.



Regulatory information

FCC notices (U.S. only) and other regulatory information

For FCC notices and other regulatory information, see the regulatory compliance website located at www.dell.com/regulatory_compliance



EU product database for energy label and product information sheet

G2524H: <https://eprel.ec.europa.eu/qr/1522307>



Contacting Dell

To contact Dell for sales, technical support, or customer service issues, see www.dell.com/contactdell.

-  **NOTE: Availability varies by country and product, and some services may not be available in your country.**
-  **NOTE: If you do not have an active internet connection, you can find contact information on your purchase invoice, packing slip, bill, or Dell product catalog.**

