



Cisco UCS C24 M3 High-Density Small Form Factor Rack-Mount Server

CISCO SYSTEMS
170 WEST TASMAN DR.
SAN JOSE, CA, 95134
WWW.CISCO.COM

PUBLICATION HISTORY

REV A.1 NOVEMBER 2, 2012

CONTENTS

OVERVIEW	3
DETAILED VIEWS	4
Chassis Front View	4
Chassis Rear View	5
BASE SERVER STANDARD CAPABILITIES and FEATURES	6
CONFIGURING the SERVER	8
STEP 1 VERIFY SERVER SKU	9
STEP 2 SELECT CPU(s)	10
STEP 3 SELECT MEMORY	11
STEP 4 SELECT RAID CONFIGURATION	14
STEP 5 SELECT HARD DISK DRIVES (HDDs)	17
STEP 6 SELECT PCIe OPTION CARD(s)	19
STEP 7 ORDER OPTIONAL NETWORK CARD ACCESSORIES	21
STEP 8 SELECT AC POWER CORD(s)	24
STEP 9 ORDER POWER SUPPLIES	27
STEP 10 ORDER OPTIONAL REVERSIBLE CABLE MANAGEMENT ARM	28
STEP 11 ORDER A TRUSTED PLATFORM MODULE	29
STEP 12 ORDER OPTIONAL USB 2.0 DRIVES	30
STEP 13 SELECT OPERATING SYSTEM	31
STEP 14 SELECT OPERATING SYSTEM MEDIA KIT	33
STEP 15 SELECT OPTIONAL VALUE-ADDED SOFTWARE	34
STEP 16 SELECT SERVICE and SUPPORT LEVEL	35
OPTIONAL STEP - ORDER RACK(s)	39
OPTIONAL STEP - ORDER PDU	40
SUPPLEMENTAL MATERIAL	41
CHASSIS	41
CPUs and DIMMs	42
Physical Layout	42
Memory Population Rules	43
Recommended Memory Population	44
Supported DIMM Populations	45
Low-Voltage DIMM Considerations	46
RACKS	47
PDUs	49
Motherboard USB Port	50
LED Indicators	51
Front Panel	51
Rear Panel	53
TECHNICAL SPECIFICATIONS	55
Dimensions and Weight	55
Power Specifications	55
Environmental Specifications	57
Compliance Requirements	58

OVERVIEW

The Cisco® UCS C24 M3 Rack Server combines economics and a density-optimized feature set from entry level enterprise to SMB with applications such as scale out, virtualization, IT and web infrastructure, VPN servers, file/print servers, and appliances.

Building on the success of the Cisco UCS C-Series Rack Servers, the Cisco UCS C24 M3 rack server and the Cisco 1225 VIC extend the capabilities of the Cisco UCS portfolio in a 2 RU form factor with the Intel® Xeon® processor E5-2400 series processor family CPUs, which deliver the best combination of performance, flexibility, and efficiency gains. In addition, the Cisco UCS C24 M3 offers up to 12 DIMM slots, 24 disk drives, 5 PCIe slots, and two 1 Gigabit Ethernet LAN-on-motherboard (LOM) ports to provide exceptional levels of internal storage and price/performance.

The 24-drive version of the server has a SAS expander enabled backplane that supports up to 24 hard disk drives with a single RAID card.

Figure 1 Cisco UCS C24 M3 High-Density SFF Rack Server

Front View



Rear View



DETAILED VIEWS

Chassis Front View

Figure 2 shows the Cisco UCS C24 M3 High-Density SFF Rack Server.

Figure 2 Chassis Front View

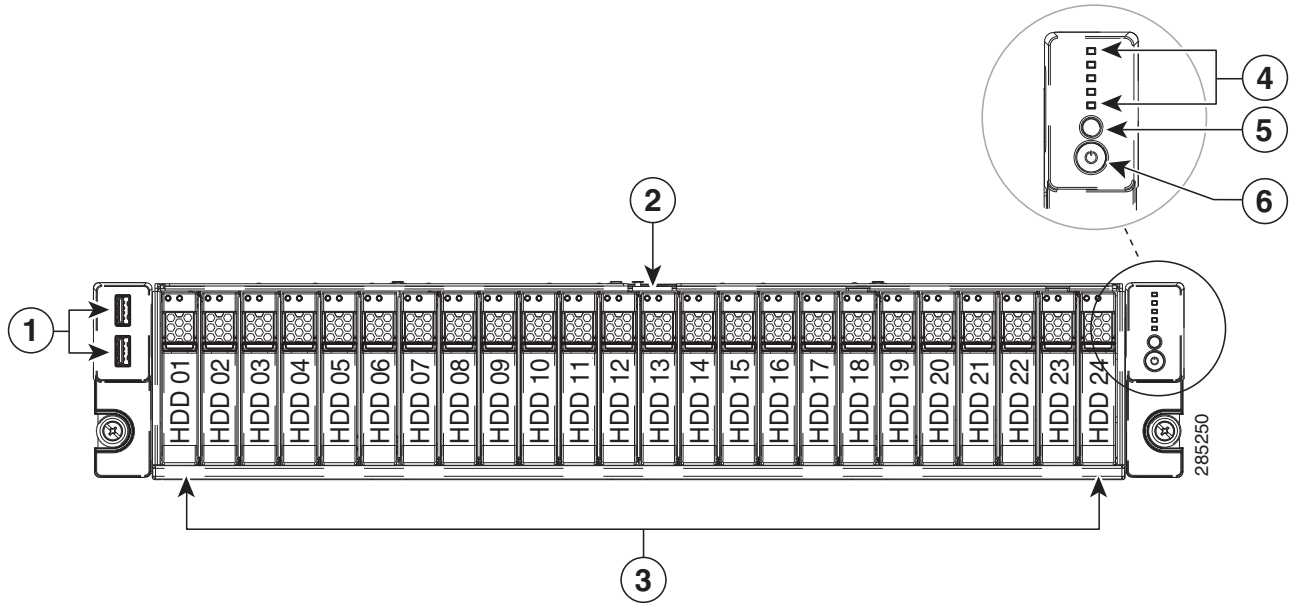

1	USB 2.0 ports (two)	4	Status LEDs (top to bottom): Network activity LED Power supply status LED Temperature status LED Fan Status LED System status LED
2	Pull-out asset tag	5	Identification button/LED
3	Drives, hot-swappable (up to twenty-four 2.5-inch drives for the 24-drive backplane option)	6	Power button/power status LED

Chassis Rear View

Figure 3 shows the external features of the rear panel.

Figure 3 Chassis Rear View

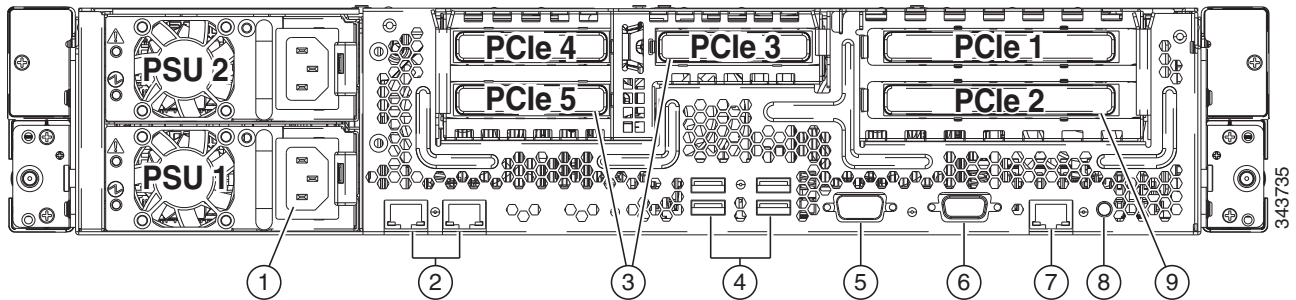

1	Power supplies (two)	6	VGA video port (DB-15 connector)
2	Dual 1 Gb Ethernet ports (LAN1, LAN2)	7	10/100/1000 Ethernet dedicated management port
3	PCIe half-height slots 3, 4, and 5 on riser 2 (x16 PCIe Gen 3 slot, x16 connector, half-length, half-height)	8	Rear Identification button/LED
4	USB ports (4)	9	PCIe full-height slots 1 and 2 on riser 1 (x16 PCIe Gen 3 slot, x16 extended connector (Cisco CNIC), half-length, full-height)
5	Serial port (DB-9 connector)	-	-

BASE SERVER STANDARD CAPABILITIES and FEATURES

Table 1 lists the capabilities and features of the base server. Details about how to configure the server for a particular feature or capability (for example, number of processors, disk drives, or amount of memory) are provided in [CONFIGURING the SERVER, page 8](#).

Table 1 Capabilities and Features

Capability/Feature	Description
Chassis	Two rack unit (2RU) chassis
CPU	Two Intel® Xeon E5-2400 series processor family CPUs
Chipset	Intel C600 chipset
Memory	12 DIMM slots
NIC	Embedded dual-port Intel I350 PCIe-based Gigabit Ethernet controller
Expansion slots	<p>Two riser cards containing PCIe card slots</p> <ul style="list-style-type: none"> ■ Riser 1 (controlled by CPU 1) <ul style="list-style-type: none"> • One x16 PCIe Gen 3 slot, x16 extended connector (Cisco CNIC), half-length, full-height, with NCSI¹ and Cisco CNIC² support. The Cisco 1225 virtual interface card requires an NCSI slot. • One x4 PCIe Gen 3 slot, x8 connector, half-length, full-height, no NCSI support ■ Riser 2 (controlled by CPU 2) <ul style="list-style-type: none"> • One x8 PCIe Gen 3 slot, x16 connector, half-length, half-height • One x8 PCIe Gen 3 slot, x8 connector, half-length, half-height • One x8 PCIe Gen 3 slot, x8 connector, half-length, half-height
Storage controller	<p>The 24-drive version of the server supports the following RAID controllers:</p> <ul style="list-style-type: none"> ■ RAID plug-in controller card options (these cards consume PCIe slots): <ul style="list-style-type: none"> • LSI MegaRAID 9265CV-8i (with 1 GB Transportable Memory Module (TMM) data cache and SuperCap for data cache power backup) • LSI MegaRAID 9240-8i • LSI MegaRAID 9220-8i ■ The server backplane configuration is as follows: <ul style="list-style-type: none"> • A 24-drive backplane with an expander. With this backplane, the 9265CV-8i controller supports up to 24 internal drives and the 9240-8i and 9220-8i controllers each support up to 16 internal drives.
Internal storage devices	<ul style="list-style-type: none"> ■ With the 24-drive backplane, up to 24 2.5-inch SAS or SATA hot-swappable hard disk drives (HDDs) ■ One connector on the motherboard that can accommodate a USB 2.0 drive. You can order an 8 GB drive for this connector and use it as a hypervisor or license dongle. The 8 GB USB drive comes blank.

Capability/Feature	Description
External Storage Devices	<ul style="list-style-type: none"> ■ A 16 GB USB 2.0 drive (if ordered) comes as a separate item in the shipping box and contains preloaded drivers and utilities. You can move the 16 GB drive from one server to another an using external USB 2.0 connector in order to install the drivers and utilities onto multiple servers.
Video	<p>The Emulex Pilot 3 Integrated Baseboard Management Controller provides video:</p> <ul style="list-style-type: none"> ■ Matrox G200e video controller ■ Integrated 2D graphics core with hardware acceleration ■ Supports all display resolutions up to 1920 x 1200 x 16 bpp resolution at 60 Hz ■ 24-bit color depth for all resolutions less than 1600x1200 ■ Up to 256 MB video memory
Interfaces	<ul style="list-style-type: none"> ■ Rear panel <ul style="list-style-type: none"> • One DB9 serial port connector • Four USB 2.0 port connectors • One DB15 VGA connector • One 10/100/1000 Ethernet management port • Two 1 GbE Ethernet LOM ports ■ Front panel <ul style="list-style-type: none"> • Two USB 2.0 ports
Front Panel	<ul style="list-style-type: none"> ■ A front panel controller provides status indications and control buttons
Power subsystem	<p>One or two power supplies, depending on server configuration and loading. Power supplies available are 450 W or 650 W (no mixing). With two power supplies, 1 + 1 redundancy is provided if the load can be carried with one supply. Prior to making a power supply selection, the UCS Power Calculator should be run to determine the right size power supply for your server configuration. The UCS Power Calculator can be found at the following link:</p> <p>https://express.salire.com/Go/Cisco/Cisco-UCS-Power-Calculator.aspx</p>
Fans	<p>Chassis:</p> <ul style="list-style-type: none"> ■ Four hot-swappable fans for front-to-rear cooling. N + 1 redundant. <p>Power supply:</p> <ul style="list-style-type: none"> ■ The power supplies are equipped with fans.
Integrated management processor	<p>Cisco Integrated Management Controller (CIMC).</p> <p>Depending on your CIMC settings, the CIMC can be accessed through the 1-Gb Ethernet dedicated management port, the 1-Gb Ethernet LOM ports, or a Cisco 1225 virtual interface card.</p>

Notes . . .

1. NCSI = network communications services interface protocol. The slot stays active when the server is in standby power state.
2. CNIC = Cisco network interface card.

CONFIGURING the SERVER

Follow these steps to configure the Cisco UCS C24 M3 High-Density SFF Rack Server:

- [STEP 1 VERIFY SERVER SKU, page 9](#)
- [STEP 2 SELECT CPU\(s\), page 10](#)
- [STEP 3 SELECT MEMORY, page 11](#)
- [STEP 4 SELECT RAID CONFIGURATION, page 14](#)
- [STEP 5 SELECT HARD DISK DRIVES \(HDDs\), page 17](#)
- [STEP 6 SELECT PCIe OPTION CARD\(s\), page 19](#)
- [STEP 7 ORDER OPTIONAL NETWORK CARD ACCESSORIES, page 21](#)
- [STEP 8 SELECT AC POWER CORD\(s\), page 24](#)
- [STEP 9 ORDER POWER SUPPLIES, page 27](#)
- [STEP 10 ORDER OPTIONAL REVERSIBLE CABLE MANAGEMENT ARM, page 28](#)
- [STEP 11 ORDER A TRUSTED PLATFORM MODULE, page 29](#)
- [STEP 12 ORDER OPTIONAL USB 2.0 DRIVES, page 30](#)
- [STEP 13 SELECT OPERATING SYSTEM, page 31](#)
- [STEP 14 SELECT OPERATING SYSTEM MEDIA KIT, page 33](#)
- [STEP 15 SELECT OPTIONAL VALUE-ADDED SOFTWARE, page 34](#)
- [STEP 16 SELECT SERVICE and SUPPORT LEVEL, page 35](#)
- [OPTIONAL STEP - ORDER RACK\(s\), page 39](#)
- [OPTIONAL STEP - ORDER PDU, page 40](#)

STEP 1 VERIFY SERVER SKU

The 24-drive version of the server has a SAS expander enabled backplane that supports up to 24 hard disk drives with a single RAID card.

Verify the product ID (PID) of the server as shown in [Table 2](#).

Table 2 PID of the C24 M3 High-Density SFF Rack Base Server

Product ID (PID)	Description
UCSC-C24-M3S	UCS C24 M3 SFF with rail kit, without PSU, CPU, memory, HDD, or PCIe cards

The Cisco C24 M3 server:

- Includes a rail kit
- Does not include power supply, CPU, memory, hard disk drives (HDDs), or plug-in PCIe cards.



NOTE: Use the steps on the following pages to configure the server with the components that you want to include.

STEP 2 SELECT CPU(s)

The standard CPU features are:

- Intel Xeon E5-2400 series processor family CPUs
- Intel C600 chipset
- Cache size of 10, 15, or 20 MB

Select CPUs

The available CPUs are listed in [Table 3](#).

Table 3 Available Intel CPUs: Xeon E5-24xx Series

Product ID (PID)	Intel Number	Clock Freq (GHz)	Power (W)	Cache Size (MB)	Cores	QPI	Highest DDR3 DIMM Clock Support (MHz) ¹
UCS-CPU-E5-2470	E5-2470	2.30	95	20	8	8.0	1600
UCS-CPU-E5-2450	E5-2450	2.10	95	20	8	8.0	1600
UCS-CPU-E5-2440	E5-2440	2.40	95	15	6	7.2	1333
UCS-CPU-E5-2420	E5-2420	1.90	95	15	6	7.2	1333
UCS-CPU-E5-2403	E5-2403	1.80	80	10	4	6.4	1066
UCS-CPU-E5-2430L	E5-2430L	2.00	60	15	6	6.4	1333

Notes . . .

1. If higher or lower speed DIMMs are selected than what is shown in the table for a given CPU, the DIMMs will be clocked at the lowest common denominator of CPU clock and DIMM clock.

Approved Configurations

- Select two CPUs from any one of the rows of [Table 3 on page 10](#).

Caveats

- You must select two CPUs.
- For optimal performance, select DIMMs with the highest clock speed for a given processor (see [Table 3 on page 10](#)). If you select DIMMs whose speeds are lower or higher than that shown in the tables, suboptimal performance will result.

STEP 3 SELECT MEMORY

The standard memory features are:

- DIMMs
 - Clock speed: 1333 or 1600 MHz
 - Ranks per DIMM: 1 or 2
 - Operational voltage: dual voltage capable (1.5 V or 1.35 V)
 - Registered ECC DDR3 DIMMS (RDIMMS)
- Memory is organized with three memory channels per CPU, with up to two DIMMs per channel, as shown in [Figure 4](#).

Figure 4 C24 M3 SFF Memory Organization

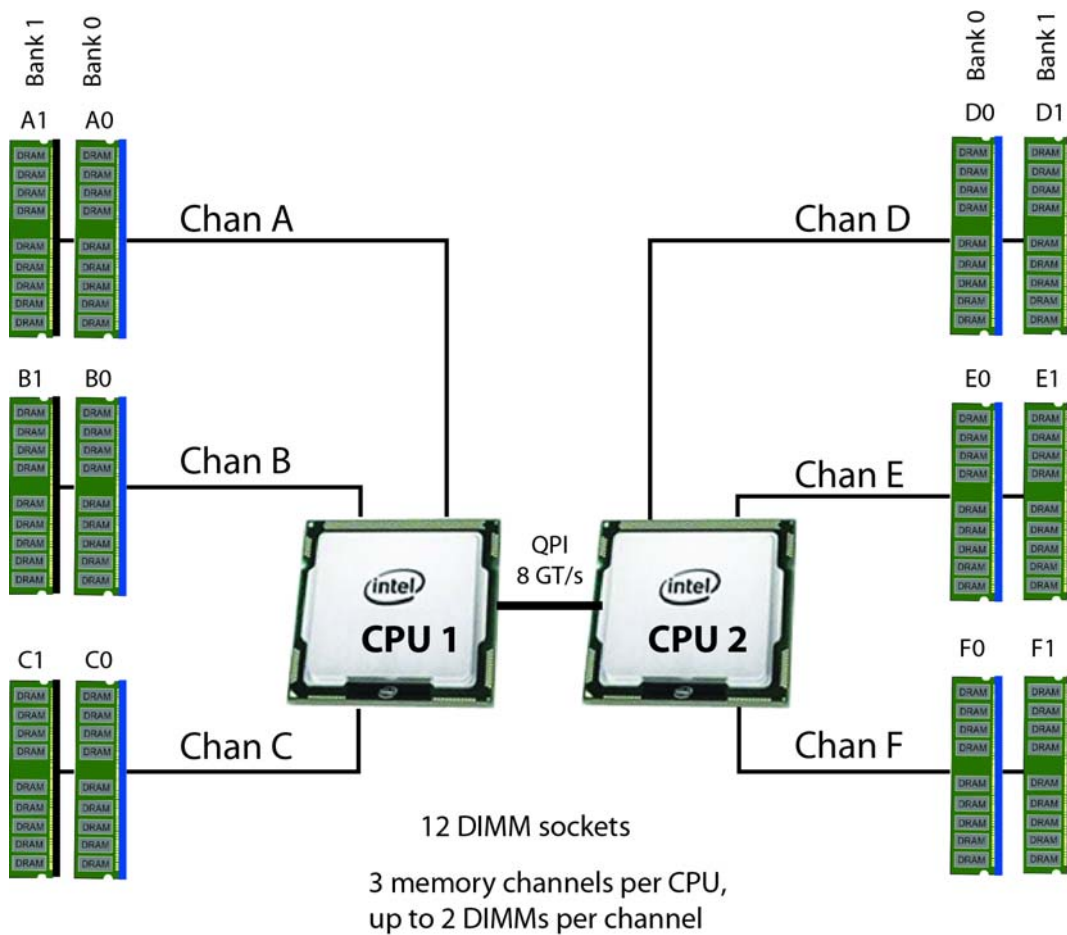

Select DIMMs

Select the memory configuration. The available memory DIMMs are listed in [Table 4](#).



NOTE: When memory mirroring is enabled, the memory subsystem simultaneously writes identical data to two channels. If a memory read from one of the channels returns incorrect data due to an uncorrectable memory error, the system automatically retrieves the data from the other channel. A transient or soft error in one channel does not affect the mirrored data, and operation continues unless there is a simultaneous error in exactly the same location on a DIMM and its mirrored DIMM. Memory mirroring reduces the amount of memory available to the operating system by 50% because only one of the two populated channels provides data.

Table 4 Available DDR3 DIMMs

Product ID (PID)	PID Description	Voltage	Ranks/ DIMM
DIMM Options			
UCS-MR-1X041RY-A	4GB DDR3-1600-MHz RDIMM/PC3-12800/1R/x4/1.35v/35nm	1.35 V	1
UCS-MR-1X082RX-A	8GB DDR3-1333-MHz RDIMM/PC3-10600/2R/x4/1.35v/35nm	1.35 V	2
UCS-MR-1X082RY-A	8GB DDR3-1600-MHz RDIMM/PC3-12800/2R/x4/1.35v/35nm	1.35 V	2
UCS-MR-1X162RY-A	16GB DDR3-1600-MHz RDIMM/PC3-12800/2R/x4/1.35v/35nm	1.35 V	2
Memory Mirroring Option			
N01-MMIRROR	Memory mirroring option		

Approved Configurations

(1) 2-CPU configuration without memory mirroring:

- Select from 1 to 6 DIMMs per CPU (2 to 12 DIMMs total). Refer to [Memory Population Rules, page 43](#), for more detailed information.

(2) 2-CPU configuration with memory mirroring:

- Select 2 or 4 DIMMs per CPU (4 or 8 DIMMs total). The DIMMs will be placed by the factory as shown in the following table:

Number of DIMMs per CPU	DIMM Placement (Channels C and F are not used with memory mirroring)	
2	CPU 1: 1 DIMM in Channel A 1 DIMM in Channel B	CPU 2: 1 DIMM in Channel D 1 DIMM in channel E
4	CPU 1: 2 DIMMs in Channel A 2 DIMMs in Channel B	CPU 2: 2 DIMMs in Channel D 2 DIMMs in Channel E

- Select the memory mirroring option (N01-MMIRROR) as shown in [Table 4 on page 12](#).



NOTE: System performance is optimized when the DIMM type and quantity are equal for both CPUs.

Caveats

- Do not mix 1333-MHz with 1600-MHz DIMMs
- Do not mix DIMM types (RDIMM, LRDIMM, or UDIMM)
- Do not select more than two different types of DIMMs (only two PID types allowed)
- For the required 2-CPU configuration, install a minimum of 2 DIMMs (one per CPU).
- If you use different types of DIMMs, the quantity of each type of DIMM must be even (2, 4, or 6). For example, 4 UCS-MR-1X082RY-A DIMMs and 6 UCS-MR-1X162RY-A DIMMs. Also, the sum of all PIDs must adhere to the maximum quantity rule of 12 DIMMs for 2-CPU systems.
- By default, all DIMMs run at 1.35 V, which yields 1333-MHz memory speeds. To run the memory DIMMs at 1600 MHz, you need to go into the BIOS or set the policy with UCSM (service profile) to run in Performance Mode. This forces the DIMMs to operate at 1.5 V and yields 1600-MHz speeds, provided:
 - The DIMMs are 1600-MHz devices
 - The CPUs chosen support 1600-MHz operation.

For more information regarding memory, see [CPUs and DIMMs, page 42](#).

STEP 4 SELECT RAID CONFIGURATION

For the 24-drive version of the server, the RAID controller choices are:

(1) One plug-in RAID controller card.

Cisco can provide factory-configured RAID systems depending on the RAID controller chosen and the number of drives ordered. Factory-configured RAID options are listed in *Table 5* along with each RAID card description. RAID levels 50 and 60 are supported, although they are not available as factory-configured RAID options.



NOTE: The 24-drive version of the server does not support embedded RAID, which is normally installed on the motherboard and does not consume a PCIe slot. The only RAID support available is through a plug-in RAID controller PCIe card.

Select RAID Controller Options

Select one RAID controller and an appropriate RAID configuration option listed in *Table 5*.

Table 5 Available Plug-In Card RAID Options

Product ID (PID)	PID Description
RAID Controllers	
UCS-RAID-9265CV	LSI MegaRAID 9265CV-8i (with SuperCap power backup) <ul style="list-style-type: none"> ■ Supports up to 24 internal SAS or SATA drives. SAS and SATA drives can be mixed. ■ Includes a 1 GB Transportable Memory Module (TMM) cache and SuperCap power module for data cache backup ■ RAID levels supported: RAID 0, 1, 10, 5, 50, 6, 60 (see the RAID Configuration Options section later in this table)
UCSC-RAID-9240-8i	LSI MegaRAID 9240-8i <ul style="list-style-type: none"> ■ Supports up to 16 internal SAS or SATA drives with the 24-drive backplane plus expander option. SAS and SATA drives can be mixed. ■ No data cache backup. There is no direct attached buffer memory. The controller utilizes system RAM for buffer cache memory. ■ RAID levels supported: RAID 0, 1, 10, 5, 50 (see the RAID Configuration Options section later in this table)
UCSC-RAID-9220-8i	LSI MegaRAID 9220-8i <ul style="list-style-type: none"> ■ Supports up to 16 internal SAS or SATA drives with the 24-drive backplane plus expander option. SAS and SATA drives can be mixed. ■ No data cache backup. There is no direct attached buffer memory. The controller utilizes system RAM for buffer cache memory. ■ RAID levels supported: RAID 0, 1, 10 (see the RAID Configuration Options section later in this table)

Table 5 Available Plug-In Card RAID Options (*continued*)

Product ID (PID)	PID Description
RAID Configuration Options	
R2XX-RAID0	Factory preconfigured RAID striping option Enable RAID 0 Setting. Requires a minimum of one hard drive.
R2XX-RAID1	Factory preconfigured RAID mirroring option Enable RAID 1 Setting. Requires exactly two drives with the same size, speed, capacity.
R2XX-RAID5	Factory preconfigured RAID option Enable RAID 5 Setting. Requires a minimum of three drives of the same size, speed, capacity.
R2XX-RAID6	Factory preconfigured RAID option Enable RAID 6 Setting. Requires a minimum of four drives of the same size, speed, capacity.
R2XX-RAID10	Factory preconfigured RAID option Enable RAID 10 Setting. Requires an even number of drives (minimum of four drives) of the same size, speed, capacity.



NOTE: Although RAID levels 50 and 60 are not orderable from the factory, they are supported for selected controllers as shown in [Table 5](#).



NOTE: No RAID factory preconfigured RAID option can be chosen (a factory RAID volume cannot be configured) if:

- there are no drives, or
- SAS and SATA drives are mixed, or
- different capacity drives are mixed

Approved Configurations

- For 24-drive backplane with expander systems
 - Select one of the following plug-in PCIe RAID controllers from [Table 5](#).
 - LSI MegaRAID 9265CV-8i (supports up to 24 drives)
 - LSI MegaRAID 9240-8i or LSI MegaRAID 9220-8i controller (support up to 16 drives)

Caveats

- There are two full-height PCIe slots available on riser 1 and three half-height PCIe slots available on riser 2.

- If you select a plug-in RAID controller from [Table 5](#), you can select additional optional PCIe cards from [Table 7 on page 19](#) to fill the remaining slots.
- Note that only a single Cisco 1225 Virtual Interface Card (VIC) card is supported and it must be installed in the full-length, full-height PCIe slot (slot 1) on riser 1, which is the only slot that supports NCSI. So take this into account when populating RAID controller cards.
- The optional plug-in PCIe RAID controller cards are all half-height.
- You can choose an optional RAID configuration (RAID 0, 1, 5, 6, or 10), which is preconfigured at the factory. The RAID level you choose must be an available RAID choice for the controller selected. RAID levels 50 and 60 are supported, depending on the RAID controller selected, although they are not available as configuration options.
- No RAID factory preconfigured RAID option can be chosen (a factory-configured RAID volume is not available) if:
 - there are no drives, or
 - SAS and SATA drives are mixed, or
 - different capacity drives are mixed
- You can choose one plug-in PCIe RAID controller.
- The 24-drive backplane system supports a maximum of one internal drive RAID controller.

STEP 5 SELECT HARD DISK DRIVES (HDDs)

The standard disk drive features are:

- 2.5-inch small form factor
- Hot-pluggable
- Sled-mounted

Select Drives

The available drives are listed in [Table 6](#).

Table 6 Available Hot-Pluggable Sled-Mounted HDDs

Product ID (PID)	PID Description	Drive Type	Capacity
HDDs			
A03-D146GC2	146 GB 6Gb SAS 15K RPM SFF	SAS	146 GB
UCS-HDD300GI2F105	300 GB 6Gb SAS 15K RPM SFF	SAS	300 GB
A03-D300GA2	300 GB 6Gb SAS 10K RPM SFF	SAS	300 GB
A03-D500GC3	500 GB SATA 7.2K RPM SFF	SATA	500 GB
A03-D600GA2	600 GB 6Gb SAS 10K RPM SFF	SAS	600 GB
UCS-HDD900GI2F106	900 GB 6Gb SAS 10K RPM SFF	SAS	600 GB
A03-D1TBSATA	1 TB SATA 7.2K RPM SFF	SATA	1 TB



NOTE: No factory-configured RAID option can be chosen (a factory RAID volume is not available) if:

- there are no drives, or
- SAS and SATA drives are mixed, or
- different capacity drives are mixed

Approved Configurations

(1) LSI MegaRAID 9265CV-8i (with data cache and SuperCap)

- For the 24-drive backplane with expander option, select up to 24 drives listed in [Table 6 on page 17](#).

(2) LSI MegaRAID 9240-8i or LSI MegaRAID 9220-8i

- For the 24-drive backplane with expander option, select up to 16 drives listed in [Table 6 on page 17](#)

Caveats

- You can mix SATA and SAS drives.
- No factory-configured RAID option can be chosen (a factory RAID volume is not available) if:
 - there are no drives, or
 - SAS and SATA drives are mixed, or
 - different capacity drives are mixed
- If you select one or more HDDs, you must select a PCIe RAID controller.

STEP 6 SELECT PCIe OPTION CARD(s)

The standard PCIe card offerings are:

- Converged Network Adapters (CNAs)
- Network Interface Cards (NICs)
- Host Bus Adapters (HBAs)

Select PCIe Option Cards

The available PCIe option cards are listed in [Table 7](#).

Table 7 Available PCIe Option Cards

Product ID (PID)	PID Description	Card Height
Converged Network Adapters (CNAs)		
UCSC-PCIE-CSC-02	Cisco VIC 1225 Dual Port 10Gb SFP+ CNA	Half
UCSC-PCIE-BSFP	Broadcom NetXtreme II 57712 Dual Port 10 Gigabit Ethernet PCIe Adapter Card with SFP+	Half
UCSC-PCIE-QSFP ¹	Qlogic QLE8242-CU dual-port 10 GbE FCoE CNA	Half
UCSC-PCIE-ESFP	Emulex OCe11102-FX dual-port 10 GbE FCoE CNA	Half
Network Interface Cards (NICs)		
N2XX-ABPCI01-M3	Broadcom 5709 Dual-Port Ethernet PCIe Adapter w/TOE for M3 Servers	Half
N2XX-ABPCI03-M3	Broadcom 5709 Quad Port 10/100/1Gb NIC w/TOE iSCSI for M3 Servers	Half
UCSC-PCIE-BTG	Broadcom 57712 Dual Port 10GbE 10G-BaseT w/TOE	Half
N2XX-AIPCI01	Intel 10GbE 2-Port Niantec Controller with Copper SFP+ Cable	Half
UCSC-PCIE-IRJ45	Intel Quad Port GbE controller (this is a quad-port i350 controller)	Half
Host Bus Adapters (HBAs)		
N2XX-AEPCI03	Emulex LPe 11002, 4Gb Fibre Channel PCIe Dual Channel HBA	Half
N2XX-AEPCI05	Emulex LPe 12002, 8Gb dual port Fibre Channel HBA	Half
N2XX-AQPCI03	Qlogic QLE2462, 4Gb dual port Fibre Channel HBA	Half
N2XX-AQPCI05	Qlogic QLE2562, 8Gb dual port Fibre Channel HBA	Half

Notes . . .

1. The "QSFP" in UCSC-PCIE-QSFP stands for QLogic SFP (QSFP is not to be confused with 40 GbE QSFP)

Approved Configurations

(1) No RAID controller plug-in card

- If you did not choose a plug-in RAID controller, you can select up to five PCIe option cards listed in [Table 7](#). Two PCIe cards can be plugged into riser 1 and three into riser 2.

(2) One RAID controller plug-in cards

- If you selected one plug-in RAID controller card, you can select additional PCIe option cards listed in [Table 7](#) until all of the slots are filled, if desired. The PCIe cards plug into riser 1 and riser 2.



NOTE: RAID controllers are always installed in half-height slots.

Caveats

- Only a single Cisco 1225 Virtual Interface Card (VIC) card is supported and it must be installed in the half-length, full-height PCIe slot (slot 1) on riser 1, which is the only slot that supports NCSI.
- All PCIe cards will fit in any slot, except the Cisco 1225 VIC card, which must be installed in the half-length, full-height slot (slot 1) of riser 1. The Cisco 1225 VIC card must be plugged into slot 1, which supports NCSI.
- Additional considerations for the Cisco 1225 VIC card:
 - Supports 10G SFP+ optical and copper twinax connections
 - Supported only in PCIe slot 1 of this server. Slot 1 can operate while the server is in standby power mode.
 - Requires that the server has CIMC firmware version 1.4(6) or later installed. There is a heartbeat LED on the top of the card that indicates when firmware is active.
 - To use this card for UCS integration (UCSM mode) with Cisco UCS Manager 2.0(2) or later, the minimum card-firmware and uboot image level is 2.0(2g).
- To help ensure that your operating system is compatible with the card you have selected, check the Hardware Compatibility List at this URL:

http://www.cisco.com/en/US/products/ps10477/prod_technical_reference_list.html

STEP 7 ORDER OPTIONAL NETWORK CARD ACCESSORIES

Copper twinax cables and SFP optical modules may be ordered to support the two-port network cards that are available with the server.

Choose Optional Twinax Cables

Table 8 lists the copper twinax cables available for the PCIe cards. You can choose cable lengths of 1, 3, 5, 7, or 10 meters. The two longer cables (7 and 10 meters) are active, which means that they contain active components within the SFP+ housing to improve signal quality.

Table 8 Available Twinax Cables

Product ID (PID)	PID Description
SFP-H10GB-CU1M	10GBASE-CU SFP+ Cable (1 M)
SFP-H10GB-CU3M	10GBASE-CU SFP+ Cable (3 M)
SFP-H10GB-CU5M	10GBASE-CU SFP+ Cable (5 M)
SFP-H10GB-ACU7M	10GBASE-CU SFP+ Cable (7 M)
SFP-H10GB-ACU10M	10GBASE-CU SFP+ Cable (10 M)

Approved Configurations

(1) Choose Up to Two Twinax Cables for Each Network Card Ordered

- You may choose one or two twinax cables for each network card ordered. The cables can be different lengths; however, you would normally order two cables of equal lengths to connect to the primary and redundant network switching equipment.

Caveats

The twinax cables listed in **Table 8** can be ordered only for the following PCIe cards:

- UCSC-PCIE-CSC-02 (Cisco VIC 1225 Dual Port 10Gb SFP+ CNA)
- UCS-PCIE-BSFP (Broadcom 57712)
- N2XX-AEPCI01 (Emulex OCe10102-F)
- N2XX-AIPCI01 (Intel Dual Port Ethernet X520)

Choose Optional SFP Modules

Optical Cisco SFP+ modules are listed in [Table 9](#).

Table 9 Available SFP Modules

Product ID (PID)	PID Description
SFP-10G-SR	10GBASE-SR SFP+ Module 850 nm, multimode, SR, 3.3V, LC connector, with Digital Optical Monitoring
DS-SFP-FC8G-SW	8 Gbit SFP+ Module 850 nm, multimode, SR, 3.3V, LC connector, with Digital Optical Monitoring

Approved Configurations

(1) Choose Up to Two SFP+ Modules for Each Network Card Ordered

- You may choose one or two SFP+ optical modules cables for each network card ordered. You would normally order two modules for connecting to the primary and redundant network switching equipment. With the SFP+ optical modules, you can use common fiber optic cables, widely available.

See [Figure 5 on page 23](#) for typical SFP+ and twinax connections to the network cards.

Caveats

The SFP-10G-SR optical module listed in [Table 9](#) should be ordered only for the following PCIe cards, as they do not come by default with any optical modules:

- UCSC-PCIE-CSC-02 (Cisco VIC 1225 Dual Port 10Gb SFP+ CNA)
- UCSC-PCIE-BSFP (Broadcom 57712)
- N2XX-ABPCI02 (Broadcom 57711)
- N2XX-AEPCI01 (Emulex OCe10102-F)

The DS-SFP-FC8G-SW optical module listed in [Table 9](#) should be ordered only for the following PCIe cards, as they do not come by default with any optical modules:

- N2XX-AEPCI05 (Emulex LPe 12002, 8Gb dual-port Fibre Channel HBA)

Figure 5 Network Card Connections

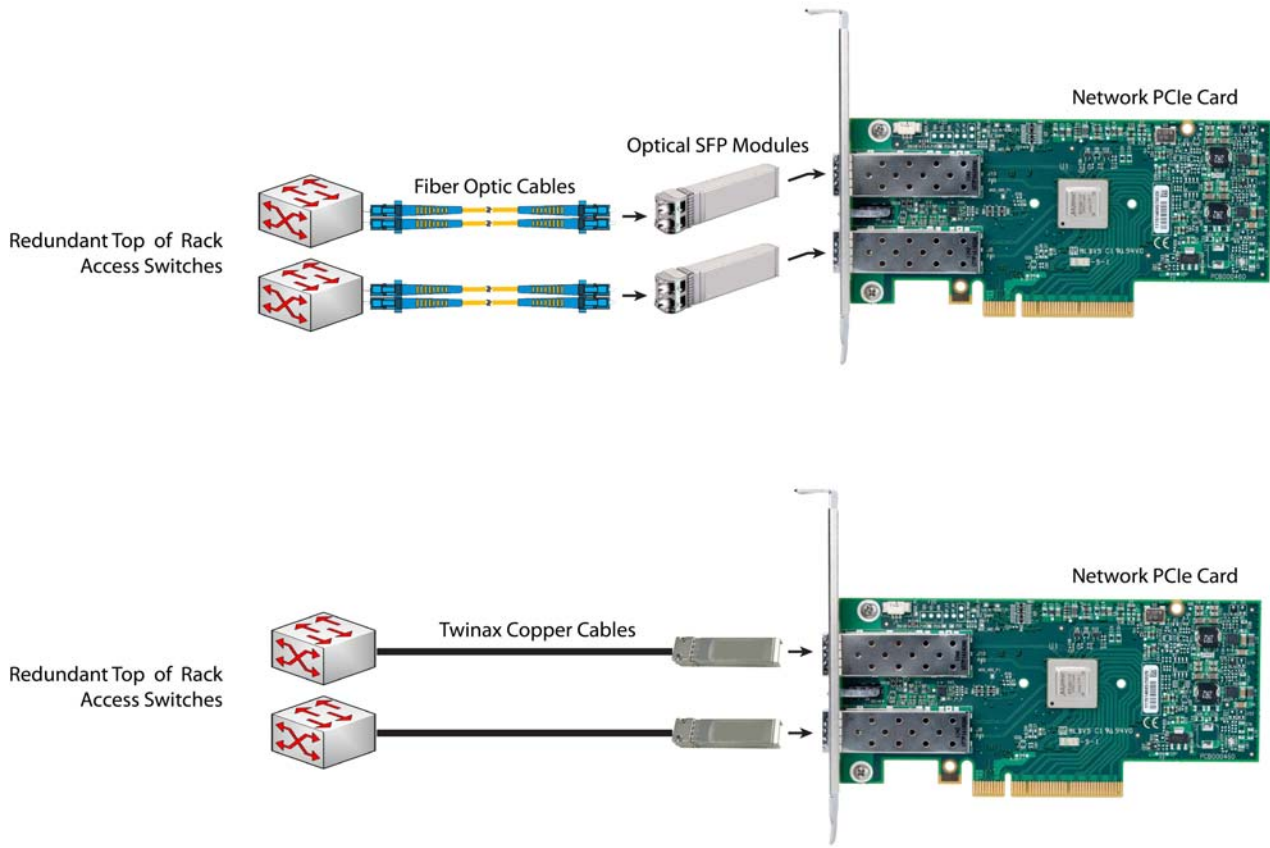

STEP 8 SELECT AC POWER CORD(S)

Using [Table 10](#), select the appropriate AC power cords. You can select a minimum of no power cords and a maximum of two. If you select the option R2XX-DMYMPWRCORD, no power cord is shipped with the server.

Table 10 Available Power Cords

Product ID (PID)	PID Description	Images
R2XX-DMYMPWRCORD	No power cord (dummy PID to allow for a no power cord option)	Not applicable
CAB-N5K6A-NA	Power Cord, 200/240V 6A, North America	
CAB-AC-250V/13A	Power Cord, NEMA L6-20 250V/20A plug-IEC320/C13 receptacle, North America,	
CAB-C13-CBN	CABASY,WIRE,JUMPER CORD, 27" L, C13/C14, 10A/250V	
CAB-C13-C14-AC	Power Cord, recessed receptacle AC power cord (27 inches)	
CAB-C13-C14-2M	CABASY,WIRE,JUMPER CORD, PWR, 2 Meter, C13/C14,10A/250V	
SFS-250V-10A-AR	Power Cord, SFS, 250V, 10A, Argentina	

Table 10 Available Power Cords

Product ID (PID)	PID Description	Images
CAB-9K10A-AU	Power Cord, 250VAC 10A 3112 Plug, Australia	
SFS-250V-10A-CN	Power Cord, SFS, 250V, 10A, China	
CAB-250V-10A-CN	AC Power Cord - 250V, 10A - PRC	
CAB-9K10A-EU	Power Cord, 250VAC 10A CEE 7/7 Plug, EU	
SFS-250V-10A-ID	Power Cord, SFS, 250V, 10A, India	
SFS-250V-10A-IS	Power Cord, SFS, 250V, 10A, Israel	
CAB-9K10A-IT	Power Cord, 250VAC 10A CEI 23-16/VII Plug, Italy	

Table 10 Available Power Cords

Product ID (PID)	PID Description	Images
CAB-9K10A-SW	Power Cord, 250VAC 10A MP232 Plug, Switzerland	 <p>Cordset rating: 10 A, 250 V Length: 8 ft. 2 in (2.5 m) Plug: MP232-R Connector: IEC 60320 C15</p>
CAB-9K10A-UK	Power Cord, 250VAC 10A BS1363 Plug (13 A fuse), UK	 <p>Cordset rating: 10 A, 250 V/500 V MAX Length: 2500mm Plug: EL 210 (BS 1363A) 13 AMP fuse Connector: EL 701C (EN 60320/C15)</p>
CAB-9K12A-NA	Power Cord, 125VAC 13A NEMA 5-15 Plug, North America	Image not available
CAB-JPN-3PIN	Power Cord 3PIN, Japan	Image not available

STEP 9 ORDER POWER SUPPLIES

The C24 M3 server accommodates two power supplies. A lightly loaded server can operate from one 650 W power supply. A fully loaded server might need to be powered with two 450 W or two 650 W power supplies (see [Table 11](#)).

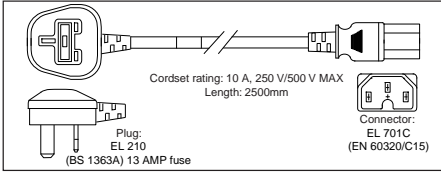
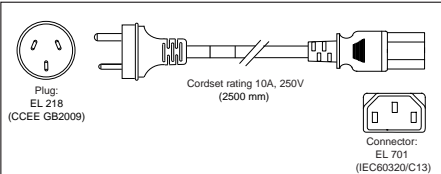
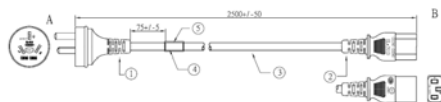
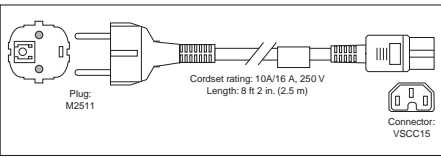
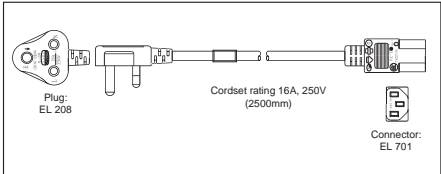
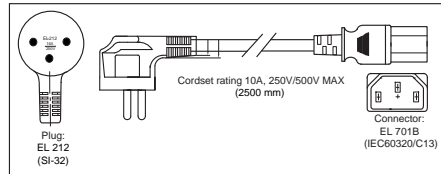
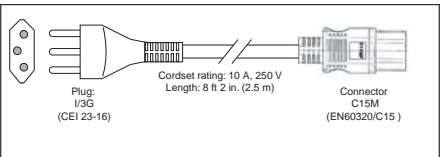
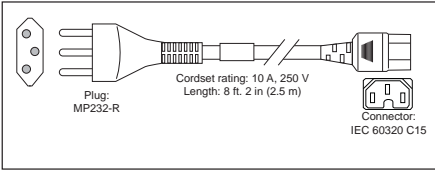
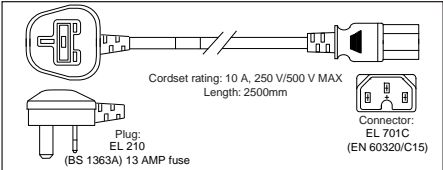
Prior to making a power supply selection, the UCS Power Calculator should be run to determine the right size power supply for your server configuration. The UCS Power Calculator can be found at the following link:

<https://express.salire.com/Go/Cisco/Cisco-UCS-Power-Calculator.aspx>

Table 11 Power Supply PIDs

Product ID (PID)	PID Description
UCSC-PSU-450W	450 W power supply
UCSC-PSU-650W	650 W power supply

Caveats

- You cannot mix power supply types. If you have two power supplies, they must be identical (either two 450 W or two 650 W power supplies).

STEP 10 ORDER OPTIONAL REVERSIBLE CABLE MANAGEMENT ARM

The reversible cable management arm mounts on either the right or left slide rails at the rear of the server and is used for cable management. Use [Table 12](#) to order a cable management arm.

Table 12 Cable Management Arm

Product ID (PID)	PID Description
UCSC-CMA1	Cable Management Arm for C24 rack servers



NOTE: If you order and install a cable management arm, you will need the longest power cable available.

For more information about the cable management arm, see the *Cisco UCS C24 M3 Installation and Service Guide* at this URL:

http://www.cisco.com/en/US/docs/unified_computing/ucs/c/hw/C24/install/C24.pdf

STEP 11 ORDER A TRUSTED PLATFORM MODULE

Trusted Platform Module (TPM) is a computer chip (microcontroller) that can securely store artifacts used to authenticate the platform (server). These artifacts can include passwords, certificates, or encryption keys. A TPM can also be used to store platform measurements that help ensure that the platform remains trustworthy. Authentication (ensuring that the platform can prove that it is what it claims to be) and attestation (a process helping to prove that a platform is trustworthy and has not been breached) are necessary steps to ensure safer computing in all environments.

The TPM ordering information is listed in [Table 13](#).

Table 13 Trusted Platform Module

Product ID (PID)	PID Description
UCSX-TPM1-001	Trusted Platform Module

STEP 12 ORDER OPTIONAL USB 2.0 DRIVES

You may order one or two optional USB 2.0 drives. One socket on the motherboard can accommodate the 8 GB drive and you can use any of the external USB 2.0 ports for the 16 GB drive.

The 8 GB drive (if ordered) is blank and comes installed on the motherboard. It can be used for a hypervisor or a license dongle. The 16 GB drive (if ordered) comes as a separate item in the shipping box and contains preloaded drivers and utilities. You can move the 16 GB drive from one server to another in order to install the drivers and utilities onto multiple servers.

The USB drive ordering information is listed in [Table 14](#).

Table 14 USB 2.0 Drive

Product ID (PID)	PID Description
UCS-USBFLSHA-8GB	8GB Flash USB Drive for C22/C24
UCS-USBFLSHA-16GB	16GB Flash USB Drive for C22/C24, preloaded with UCS SCU/HUU bootable images and driver ISO file

See [Figure 6 on page 41](#) for the location of the internal 8 GB USB connector.

STEP 13 SELECT OPERATING SYSTEM

Several operating systems are available from which to choose. Select one of the operating systems shown in [Table 15](#).

Table 15 Operating Systems

PID Description	Product ID (PID)
SUSE Linux Enterprise Server	
SLES-1A	SLES/1yr subscription/svcs required/0 media
SLES-3A	SLES/3yr subscription/svcs required/0 media
Red Hat Enterprise Linux	
RHEL-2S-1G-1A	RHEL/2 Socket/1 Guest/1Yr Svcs Required
RHEL-2S-1G-3A	RHEL/2 Socket/1 Guest/3Yr Svcs Required
RHEL-2S-4G-1A	RHEL/2 Socket/4 Guest/1Yr Svcs Required
RHEL-2S-4G-3A	RHEL/2 Socket/4 Guest/3Yr Svcs Required
RHEL-2S-UG-1A	RHEL/2 Socket/U Guest/1Yr Svcs Required
RHEL-2S-UG-3A	RHEL/2 Socket/U Guest/3Yr Svcs Required
RHEL Add-Ons	
RHEL-HA-2S-1A	RHEL Option/High-Availability/2 Socket/1Yr Svcs Required
RHEL-RS-2S-1A	RHEL Option/Resilient w/Ha /2 Socket/1 Yr Svcs Required
RHEL-SFS-2S-1A	RHEL Option/Scalable File System/2 Socket/1 Yr Svcs Required
RHEL-HA-2S-3A	RHEL Option/High-Availability/2 Socket/3Yr Svcs Required
RHEL-RS-2S-3A	RHEL Option/Resilient Storage w/ HA /2 Socket/3 Yr Svcs Reqd
RHEL-SFS-2S-3A	RHEL Option/Scalable File System/2 Socket/3 Yr Svcs Required
Windows Server	
MSWS-08R2-STHV	Windows Svr 2008 ST media R2 ST (1-4CPU, 5CAL)
MSWS-08R2-ENHV	Windows Svr 2008 EN media R2 EN (1-8CPU, 25CAL)
MSWS-08R2-DCHV2S	Windows Svr 2008 R2-2 CPU-Data Center
MSWS-08R2-DCHV4S	Windows Svr 2008 R2-4 CPU-Data Center

Table 15 Operating Systems *(continued)*

PID Description	Product ID (PID)
VMWare Server	
VMW-VS5-STD-1A	VMware vSphere 5 Standard for 1 Processor, 1 Year, Support Rqd
VMW-VS5-STD-2A	VMware vSphere 5 Standard for 1 Processor, 2 Year, Support Rqd
VMW-VS5-STD-3A	VMware vSphere 5 Standard for 1 Processor, 3 Year, Support Rqd
VMW-VS5-STD-4A	VMware vSphere 5 Standard for 1 Processor, 4 Year, Support Rqd
VMW-VS5-STD-5A	VMware vSphere 5 Standard for 1 Processor, 5 Year, Support Rqd
VMW-VS5-ENT-1A	VMware vSphere 5 Enterprise for 1 Processor, 1 Year Support
VMW-VS5-ENT-2A	VMware vSphere 5 Enterprise for 1 CPU, 2 Yr Support
VMW-VS5-ENT-3A	VMware vSphere 5 Enterprise for 1 CPU, 3 Yr Support
VMW-VS5-ENT-4A	VMware vSphere 5 Enterprise for 1 Processor, 4 Year Support
VMW-VS5-ENT-5A	VMware vSphere 5 Enterprise for 1 CPU, 5 Yr Support
VMW-VS5-ENTP-1A	VMware vSphere 5 Enterprise Plus for 1 Processor, 1 Year, Support Rqd
VMW-VS5-ENTP-2A	VMware vSphere 5 Enterprise Plus for 1 CPU, 2 Yr Support
VMW-VS5-ENTP-3A	VMware vSphere 5 Enterprise Plus for 1 Processor, 3 Year, Support Rqd
VMW-VS5-ENTP-4A	VMware vSphere 5 Enterprise Plus for 1 Processor, 4 Year Support
VMW-VS5-ENTP-5A	VMware vSphere 5 Enterprise Plus for 1 Processor, 5 Year, Support Rqd

STEP 14 SELECT OPERATING SYSTEM MEDIA KIT

Select the optional operating system media listed in [Table 16](#).

Table 16 OS Media

Product ID (PID)	PID Description
RHEL-6	RHEL 6 Recovery Media Only (Multilingual)
SLES-11	SLES 11 media only (multilingual)
MSWS-08R2-STHV-RM	Windows Svr 2008 R2 ST (1-4CPU, 5CAL), Media
MSWS-08R2-ENHV-RM	Windows Svr 2008 R2 EN (1-8CPU, 25CAL), Media
MSWS-08R2-DCHV-RM	Windows Svr 2008 R2 DC (1-8CPU, 25CAL), Media

STEP 15 SELECT OPTIONAL VALUE-ADDED SOFTWARE

You can select from a variety of value-added software listed in [Table 17](#).

Table 17 Value Added Software

Product ID (PID)	PID Description
BMC-SE-4C	BMC BladeLogic Standard Edition, 4 Cores, Support Required
BMC-SE-6C	BMC BladeLogic Standard Edition, 6 Cores, Support Required
BMC-SE-8C	BMC BladeLogic Standard Edition, 8 Cores, Support Required
BMC-SE-10C	BMC BladeLogic Standard Edition, 10 Cores, Support Required
BMC-AE-4C	BladeLogic Advanced Edition, 4 Cores, Support Required
BMC-AE-6C	BMC BladeLogic Advanced Edition, 6 Cores, Support Required
BMC-AE-8C	BMC BladeLogic Advanced Edition, 8 Cores, Support Required
BMC-AE-10C	BMC BladeLogic Advanced Edition, 10 Cores, Support Required
BMC-002	BMC BladeLogic CM, Physical Server
BMC-012	BMC BPPM Per Server
VMW-VC5-STD-1A	VMware vCenter 5 Standard for 1 Processor, 1 Year, Support Rqd
VMW-VC5-STD-2A	VMware vCenter 5 Standard for 1 Processor, 2 Year, Support Rqd
VMW-VC5-STD-3A	VMware vCenter 5 Standard for 1 Processor, 3 Year, Support Rqd
VMW-VC5-STD-4A	VMware vCenter 5 Standard for 1 Processor, 4 Year, Support Rqd
VMW-VC5-STD-5A	VMware vCenter 5 Standard for 1 Processor, 5 Year, Support Rqd

STEP 16 SELECT SERVICE and SUPPORT LEVEL

A variety of service options are available, as described in this section.

Unified Computing Warranty, No Contract

If you have noncritical implementations and choose no service contract, the following coverage is supplied:

- Three-year parts coverage.
- Next business day (NBD) onsite parts replacement eight hours a day, five days a week.
- 90-day software warranty on media.
- Downloads of BIOS, drivers, and firmware updates.
- UCSM updates for systems with Unified Computing System Manager. These updates include minor enhancements and bug fixes that are designed to maintain the compliance of UCSM with published specifications, release notes, and industry standards.

Please visit [Cisco Unified Computing Warranty](#) for more information on the Cisco Unified Computing Warranty.

Unified Computing Warranty Plus Service

For faster parts replacement than is provided with the standard Cisco Unified Computing System warranty, Cisco offers the Cisco Unified Computing Warranty Plus Service. You can choose from several levels of advanced parts replacement coverage, including onsite parts replacement in as little as two hours. Warranty Plus provides remote access any time to Cisco support professionals who can determine if a return materials authorization (RMA) is required. See [Table 18](#).

Table 18 UCS Computing Warranty Plus Service

Product ID (PID)	On Site?	Description
CON-UCW2-C24M3S	No	UC Warranty Plus 8x5x4
CON-UCW3-C24M3S	No	UC Warranty Plus 24x7x4
CON-UCW4-C24M3S	No	UC Warranty Plus 24x7x2
CON-UCW5-C24M3S	Yes	UC Warranty Plus 8X5XNBD
CON-UCW6-C24M3S	Yes	UC Warranty Plus 8X5X4
CON-UCW7-C24M3S	Yes	UC Warranty Plus 24x7x4
CON-UCW8-C24M3S	Yes	UC Warranty Plus 24x7x2

Unified Computing Support Service

For support of the entire Cisco Unified Computing System, Cisco offers the Cisco Unified Computing Support Service. This service provides expert software and hardware support to help sustain performance and high availability of the unified computing environment. Access to the Cisco Technical Assistance Center (TAC) is provided around the clock, from anywhere in the

world. As a part of this service, Cisco will assist in issues involving third-party software that have been certified for use on the Cisco Unified Computing System

For Cisco UCS servers under Cisco Unified Computing System Manager (UCSM), you get Smart Call Home, which provides proactive, embedded diagnostics and real-time alerts. For systems that include Unified Computing System Manager, the support service includes downloads of UCSM upgrades. The Unified Computing Support Service includes flexible hardware replacement options, including replacement in as little as two hours. There is also access to Cisco's extensive online technical resources to help maintain optimal efficiency and uptime of the unified computing environment. You can choose a desired service listed in [Table 19](#).

Table 19 UCS Computing Support Service

Product ID (PID)	On Site?	Description
CON-UCS1-C24M3S	No	UC Support 8X5XNBD
CON-UCS2-C24M3S	No	UC Support 8X5X4
CON-UCS3-C24M3S	No	UC Support 24x7x4
CON-UCS4-C24M3S	No	UC Support 24x7x2
CON-UCS5-C24M3S	Yes	UC Support 8X5XNBD
CON-UCS6-C24M3S	Yes	UC Support 8X5X4
CON-UCS7-C24M3S	Yes	UC Support 24x7x4
CON-UCS8-C24M3S	Yes	UC Support 24x7x2

Unified Computing Drive Retention Service

With the Cisco Unified Computing Drive Retention (UCDR) Service, you can obtain a new disk drive in exchange for a faulty drive without returning the faulty drive. In exchange for a Cisco replacement drive, you provide a signed Certificate of Destruction (CoD) confirming that the drive has been removed from the system listed, is no longer in service, and has been destroyed.

Sophisticated data recovery techniques have made classified, proprietary, and confidential information vulnerable, even on malfunctioning disk drives. The UCDR service enables you to retain your drives and ensures that the sensitive data on those drives is not compromised, which reduces the risk of any potential liabilities. This service also enables you to comply with regulatory, local, and federal requirements.

If your company has a need to control confidential, classified, sensitive, or proprietary data, you might want to consider one of the Drive Retention Services listed in [Table 20](#).



NOTE: Cisco does not offer a certified drive destruction service as part of this service.

Table 20 Drive Retention Service Options

Service Description	Service Program Name	Service Level GSP	Service Level	Product ID (PID)
UCS Mission Critical Support Service With Drive Retention	UC CRIT DR	UCMD7	24x7x4 Onsite	CON-UCMD7-C24M3S
		UCMD8	24x7x2 Onsite	CON-UCMD8-C24M3S
UCS Support Service With Drive Retention	UC SUPP DR	UCSD1	8x5xNBD	CON-UCSD1-C24M3S
		UCSD2	8x5x4	CON-UCSD2-C24M3S
		UCSD3	24x7x4	CON-UCSD3-C24M3S
		UCSD4	24x7x2	CON-UCSD4-C24M3S
		UCSD5	8x5xNBD Onsite	CON-UCSD5-C24M3S
		UCSD6	8x5x4 Onsite	CON-UCSD6-C24M3S
		UCSD7	24x7x4 Onsite	CON-UCSD7-C24M3S
		UCSD8	24x7x2 Onsite	CON-UCSD8-C24M3S
UCS Warranty Plus With Drive Retention	UC PLUS DR	UCWD2	8x5x4	CON-UCWD2-C24M3S
		UCWD3	24x7x4	CON-UCWD3-C24M3S
		UCWD4	24x7x2	CON-UCWD4-C24M3S
		UCWD5	8x5xNBD Onsite	CON-UCWD5-C24M3S
		UCWD6	8x5x4 Onsite	CON-UCWD6-C24M3S
		UCWD7	24x7x4 Onsite	CON-UCWD7-C24M3S
		UCWD8	24x7x2 Onsite	CON-UCWD8-C24M3S

Mission Critical Support Service

This service delivers personalized technical account management, expedited technical support, and expert field support engineering for the Cisco Unified Computing System (UCS).

The Mission Critical Support Service provides a designated technical account manager (TAM) who acts as a strategic resource to help ensure that the unified computing environment runs at peak efficiency. If a problem arises that threatens business continuity, the TAM provides crisis management leadership, and your IT staff receives expedited access to Cisco's Technical Assistance Center (TAC).

Mission Critical Support Service is a layered service available for all Cisco data center products already supported by a UCS Support Service or SMARTnet service contract. For further information

about Cisco Mission Critical Support Service, please visit [Data Center Technical Support and Operations Management CEC site](#) and [Service Description](#) or contact your Cisco account Manager.

For more service and support information, see this URL:

http://www.cisco.com/en/US/services/ps2961/ps10312/ps10321/Cisco_UC_Warranty_Support_DS.pdf

For a complete listing of available services for Cisco Unified Computing System, see this URL:

http://www.cisco.com/en/US/products/ps10312/serv_group_home.html

OPTIONAL STEP - ORDER RACK(s)

The optional R42610 rack is available from Cisco for the C-Series servers, including the C24 M3 SFF server. This rack is a standard 19-inch rack and can be ordered with a variety of options, as listed in [Table 21](#). Racks are shipped separately from the C24 M3 SFF server.

Table 21 Racks and Rack Options

Product ID (PID)	PID Description
RACK-UCS ¹	Cisco R42610 expansion rack, no side panels
RACK-UCS2 ¹	Cisco R42610 standard rack, w/side panels
RACK-BLANK-001	Filler panels (qty 12), 1U, plastic, toolless
RACK-CBLMGT-001	Cable mgt D rings (qty 10), metal
RACK-CBLMGT-011	Cable mgt straps (qty 10), Velcro
RACK-FASTEN-001	Mounting screws (qty 100), M6
RACK-FASTEN-002	Cage nuts (qty 50), M6
RACK-JOIN-001	Rack joining kit

Notes . . .

1. Use these same base PIDs to order spare racks (available only as next-day replacements).

For more information about the R42610 rack, see [RACKS, page 47](#).

OPTIONAL STEP - ORDER PDU

An optional power distribution unit (PDU) is available from Cisco for the C-Series rack servers, including the C24 M3 server. This PDU is available in a zero rack unit (RU) style (see [Table 21](#)).

Table 22 PDU Options

Product ID (PID)	PID Description
RP208-30-2P-U-2	Zero RU PDU

For more information about the PDU, see [PDUs, page 49](#).

SUPPLEMENTAL MATERIAL

CHASSIS

An internal view of the C24 M3 chassis with the top cover removed is shown in *Figure 6*.

Figure 6 C24 M3 SFF With Top Cover Off

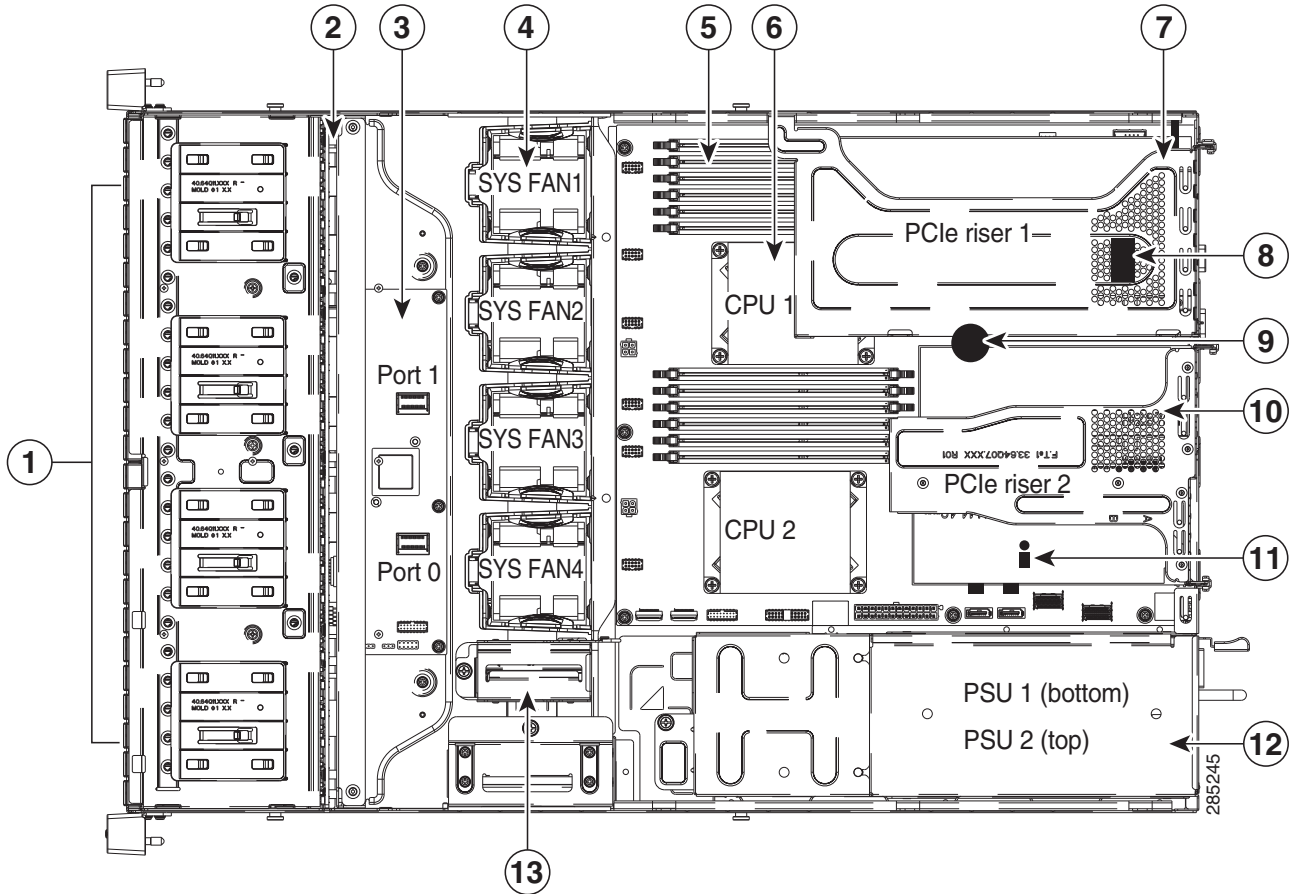

1	Drives (hot-swappable, accessed through front panel)	8	Internal USB 2.0 port on motherboard
2	Drive backplane	9	RTC battery on motherboard
3	SAS expander	10	PCIe riser 2 (three half-height slots)
4	Fan modules (4)	11	Trusted platform module socket on motherboard
5	DIMM slots on motherboard (12)	12	Power supplies (two, hot-swappable access through rear panel)

6	CPUs and heatsinks (up to two)	13	RAID backup unit mounting locations (two)
7	PCIe riser 1 (two full-height slots)	-	-

CPUs and DIMMs

Physical Layout

Each CPU has three DIMM channels:

- CPU1 has channels A, B, and C
- CPU2 has channels D, E, and F

Each DIMM channel has two banks: Bank 0 and Bank 1. The blue-colored DIMM banks are for Bank 0 and the black-colored are for Bank 1.

As an example, DIMM slots A0, B0, and C0 belong to Bank 0, while A1, B1, and C1 belong to Bank 1.

Figure 7 shows how banks and channels are physically laid out on the motherboard. The DIMM slots on the top (channels A, B, and C) are associated with CPU 1, while the DIMM slots on the bottom (channels D, E, and F) are associated with CPU 2. Bank 0 slots (blue) are populated before Bank 1 slots (black).

Figure 7 Physical Layout of CPU DIMM Channels and Banks

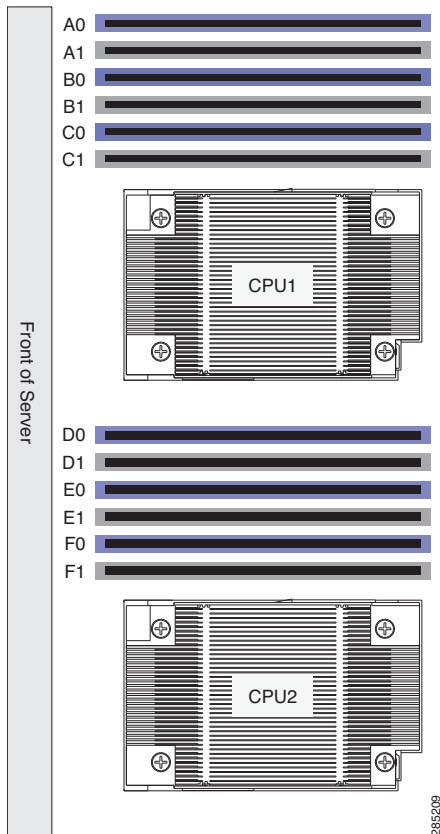

Memory Population Rules

When considering the memory configuration of your server, you should consider the following items:

- Each channel has two DIMM slots (for example, channel A = slots A0 and A1).
 - Each channel can operate with one or two DIMMs installed.
 - If a channel has only one DIMM, populate slot 0 first (the blue slot).
- When both CPUs are installed, populate the DIMM slots of each CPU identically.
 - Fill blue slots in the channels first: A0, D0, B0, E0, C0, F0
 - Fill black slots in the channels second: A1, D1, B1, E1, C1, F1
- Any DIMM installed in a DIMM socket for which the CPU is absent is not recognized.
- For optimum performance, populate at least one DIMM per memory channel per CPU.
- When populating DIMM slots, multiples of 6 DIMMs are best for achieving optimum performance, since there are 3 memory channels per CPU socket and 2 CPUs must be populated.
- At 1 DPC and 2 DPC, 1600-MHz DIMMs will run at 1600 MHz (provided the CPU supports 1600 MHz DIMMs) and 1333-MHz DIMMs will run at 1333 MHz.
- When mixing DIMMs, the following rules need to be followed:
 - When mixing DIMMs of different densities (sizes), populate DIMMs with the highest density first. For example, if you have to mix 16 GB with 8 GB DIMMs, populate 16 GB DIMMs in blue slots (or bank 0) and then 8 GB in black slots (or bank 1).
 - When mixing DIMMs with different ranks, populate DIMMs with the higher rank first. For example, populate 16 GB 2R or 8 GB 2R before 4 GB 1R DIMMs.
 - DIMMs of different sizes (4 GB, 8 GB, 16 GB) can be mixed across different channels. Total memory size in a single channel should be the same. For example, if you are mixing 4 GB and 8 GB DIMMs to achieve total 72 GB (6x8 GB + 6x4 GB) for a server, then populate blue slots with 8 GB DIMMs and black slots with 4 GB DIMMs and total memory size should be 12 GB across all 3 channels for both CPUs.
 - When mixing DIMMs, all the DIMMs in the server must be the same speed.

Recommended Memory Population

This section explains the recommended DIMM population order rules for the C24 M3 server.

- All DIMMs must be DDR3 DIMMs.
- Mixing of Registered and Unbuffered DIMMs is not allowed per platform.
- Mixing of ECC and non-ECC DIMMs is not allowed per platform.
- Do not mix 1333-MHz DIMMs with 1600-MHz DIMMs.

Follow [Table 23](#) when populating DIMMs in the server.

Table 23 Recommended DIMM Population

Total Memory Size	CPU 1		CPU 2		Total DIMMs in System
	Blue Slots Bank 0 (A0, B0, C0)	Black Slots Bank 1 (A1, B1, C1)	Blue Slots Bank 0 (D0, E0, F0)	Black Slots Bank 1 (D1, E1, F1)	
48 GB ¹	3 x 4 GB	3 x 4 GB	3 x 4 GB	3 x 4 GB	12
	3 x 8 GB	—	3 x 8 GB	—	6
72 GB	3 x 8 GB	3 x 4 GB	3 x 8 GB	3 x 4 GB	12
96 GB ²	3 x 8 GB	3 x 8 GB	3 x 8 GB	3 x 8 GB	12
	3 x 16 GB	—	3 x 16 GB	—	6
120 GB	3 x 16 GB	3 x 4 GB	3 x 16 GB	3 x 4 GB	12
144 GB	3 x 16 GB	3 x 8 GB	3 x 16 GB	3 x 8 GB	12
192 GB	3 x 16 GB	3 x 16 GB	3 x 16 GB	3 x 16 GB	12

Notes . . .

1. For 48 GB, there are two possible sweet spot configurations:
 - 6 x 8 GB occupies 1 DPC, so there is a possibility of increasing total memory size in the system (beyond 48 GB) by going to 2 DPC while still maintaining memory speed at 1600 MHz.
 - If there is no plan to increase total memory size in the system (beyond 48 GB), then 12 x 4GB is more price effective at this time.
2. For 96 GB, there are two possible optimal configurations:
 - 6 x 16GB occupies 1 DPC, so there is a possibility of increasing total memory size in the system (beyond 96 GB) by going to 2 DPC while maintaining the maximum memory speed at 1600 MHz.
 - 12 x 8GB gives the peak performance for this configuration and is recommended if there is no plan of increasing the total memory in the future.

Supported DIMM Populations

The supported DIMM populations are listed in [Table 24](#).

Table 24 Supported DIMM Configurations

CPU 1 DIMMs	# CPU 1 DIMMs	CPU 1 Capacity	CPU 2 DIMMs	# CPU 2 DIMMs	CPU 2 Capacity	Total DIMMs for both CPUs	Total Capacity for 2 CPUs
1 x 4 GB	1	4 GB	1 x 4 GB	1	4 GB	2	8 GB
2 x 4 GB	2	8 GB	2 x 4 GB	2	8 GB	4	16 GB
1 x 8 GB	1	8 GB	1 x 8 GB	1	8 GB	2	16 GB
3 x 4 GB	3	12 GB	3 x 4 GB	3	12 GB	6	24 GB
4 x 4 GB	4	16 GB	4 x 4 GB	4	16 GB	8	32 GB
2 x 8 GB	2	16 GB	2 x 8 GB	2	16 GB	4	32 GB
1 x 16 GB	1	16 GB	1 x 16 GB	1	16 GB	2	32 GB
5 x 4 GB	5	20 GB	5 x 4 GB	5	20 GB	10	40 GB
6 x 4 GB	6	24GB	6 x 4 GB	6	24GB	12	48 GB
3 x 8 GB	3	24 GB	3 x 8 GB	3	24 GB	6	48 GB
4 x 8 GB	4	32 GB	4 x 8 GB	4	32 GB	8	64 GB
2 x 16 GB	2	32 GB	2 x 16 GB	2	32 GB	4	64 GB
3 x 8 GB + 3 x 4 GB ¹	6	36 GB	3 x 8 GB + 3 x 4 GB ²	6	36 GB	12	72 GB
5 x 8 GB	5	40 GB	5 x 8 GB	5	40 GB	10	80 GB
6 x 8 GB	6	48 GB	6 x 8 GB	6	48 GB	12	96 GB
3 x 16 GB	3	48 GB	3 x 16 GB	3	48 GB	6	96 GB
3 x 16 GB + 3 x 4 GB ³	6	60 GB	3 x 16 GB + 3 x 4 GB ⁴	6	60 GB	12	120 GB
4 x 16 GB	4	64 GB	4 x 16 GB	4	64 GB	8	128 GB
3 x 8 GB + 3 x 16 GB ⁵	6	72 GB	3 x 8 GB + 3 x 16 GB ⁶	6	72 GB	12	144 GB
5 x 16 GB	5	80 GB	5 x 16 GB	5	80 GB	10	160 GB
6 x 16 GB	6	96 GB	6 x 16 GB	6	96 GB	12	192 GB

Notes . . .

1. UCS-MR-1X082RY-A + UCS-MR-1X041RY-A
2. UCS-MR-1X082RY-A + UCS-MR-1X041RY-A
3. UCS-MR-1X162RY-A + UCS-MR-1X041RY-A
4. UCS-MR-1X162RY-A + UCS-MR-1X041RY-A
5. UCS-MR-1X082RY-A + UCS-MR-1X162RY-A
6. UCS-MR-1X082RY-A + UCS-MR-1X162RY-A

Low-Voltage DIMM Considerations

The C24 M3 server can be ordered with low-voltage (1.35 V) DIMMs only. Note the following considerations:

- Low-voltage DIMMs within the server must have the identical manufacturer, type, speed, and size.
- Low-voltage DIMMs and standard-voltage DIMMs can be mixed in the same server. Note that this causes the system BIOS to default to standard-voltage operation (Performance Mode). That is, the server cannot operate in Power Saving Mode unless all DIMMs are low-voltage DIMMs.
- CPUs that have a maximum memory frequency less than 1333 MHz support low-voltage DIMMs operating in Power Saving Mode only, and do not support Performance Mode.

RACKS

The Cisco R42610 rack (see [Figure 8](#)) is certified for Cisco UCS installation at customer sites and is suitable for the following equipment:

- Cisco UCS B-Series servers and fabric interconnects
- Cisco UCS C-Series and select Nexus switches

The rack is compatible with hardware designed for EIA-standard 19-inch racks. Rack specifications are listed in [Table 25](#).

Table 25 Cisco R42610 Rack Specifications

Parameter	Standard Rack	Expansion Rack
Dimensions (H x W x D)	78.74 x 24 x 43.38 in. (2000 x 610 x 1102 mm)	78.74 x 23.58 x 43.38 in. (2000 x 599 x 1102 mm)
Dimensions (H x W x D) with packaging	89 x 33 x 47 in. (2261 x 838 x 1194 mm)	89 x 33 x 47 in. (2261 x 838 x 1194 mm)
Distance from front mounting rail to rear mounting rail	29.2 in (741 mm)	29.2 in (741 mm)
Weight	299.83 lb (136 kg)	231.49 lb (105 kg)
Weight with packaging	354 lb (161 kg)	284 lb (129 kg)
Side panels included	Yes	No
Equipment mounting capacity	42RU	42RU
Static load capacity	2100 lb (954 kg)	2100 lb (954 kg)
Dynamic load capacity	Not applicable	Not applicable



NOTE: The AC input connector is an IEC 320 C-14 15 A/250 VAC power inlet.

Figure 8 Cisco R42610 Rack



Front view - door closed



Front view - door open



Front view - door removed

PDU

Cisco RP Series Power Distribution Units (PDUs) offer power distribution with branch circuit protection.

Cisco RP Series PDU models distribute power to up to 24 outlets. The architecture organizes power distribution, simplifies cable management, and enables you to move, add, and change rack equipment without an electrician.

With a Cisco RP Series PDU in the rack, you can replace up to two dozen input power cords with just one. The fixed input cord connects to the power source from overhead or under-floor distribution. Your IT equipment is then powered by PDU outlets in the rack using short, easy-to-manage power cords.

The C-series severs accept the zero-rack-unit (ORU) PDU. See [Figure 9](#).

Figure 9 Zero Rack Unit PDU (PID = RP208-30-2P-U-2)

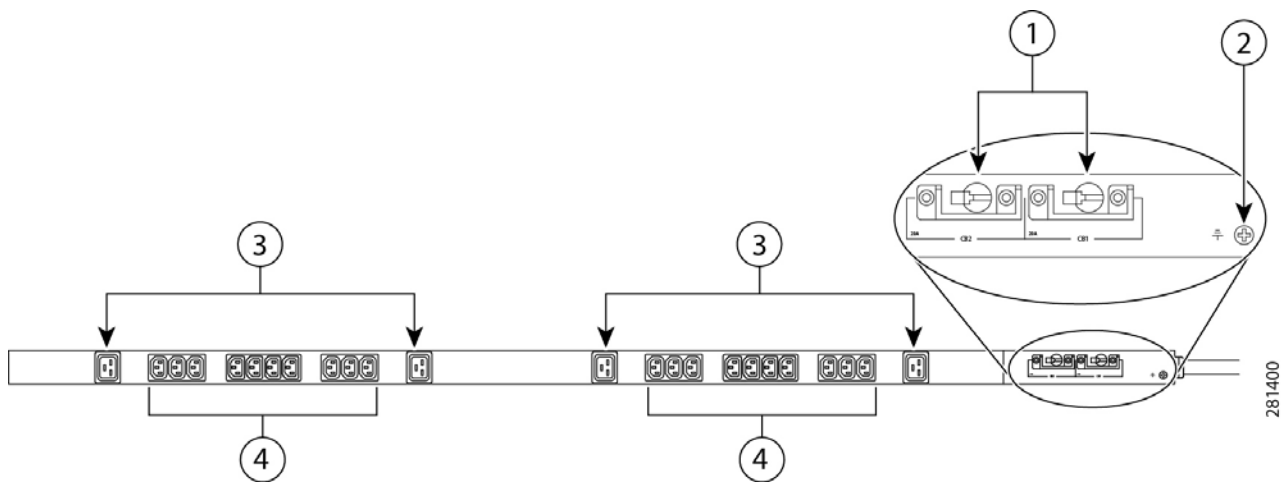

1	Breakers	3	C13 plugs
2	Ground connection	4	C19 plugs

Cisco RP Series PDU models provide two 20-ampere (A) circuit breakers for groups of receptacles. The effects of a tripped circuit are limited to a receptacle group. Simply press a button to reset that circuit.

Motherboard USB Port

The C24 M3 SFF motherboard has one general-purpose USB socket as shown in *Figure 10*.

Figure 10 Motherboard USB Port

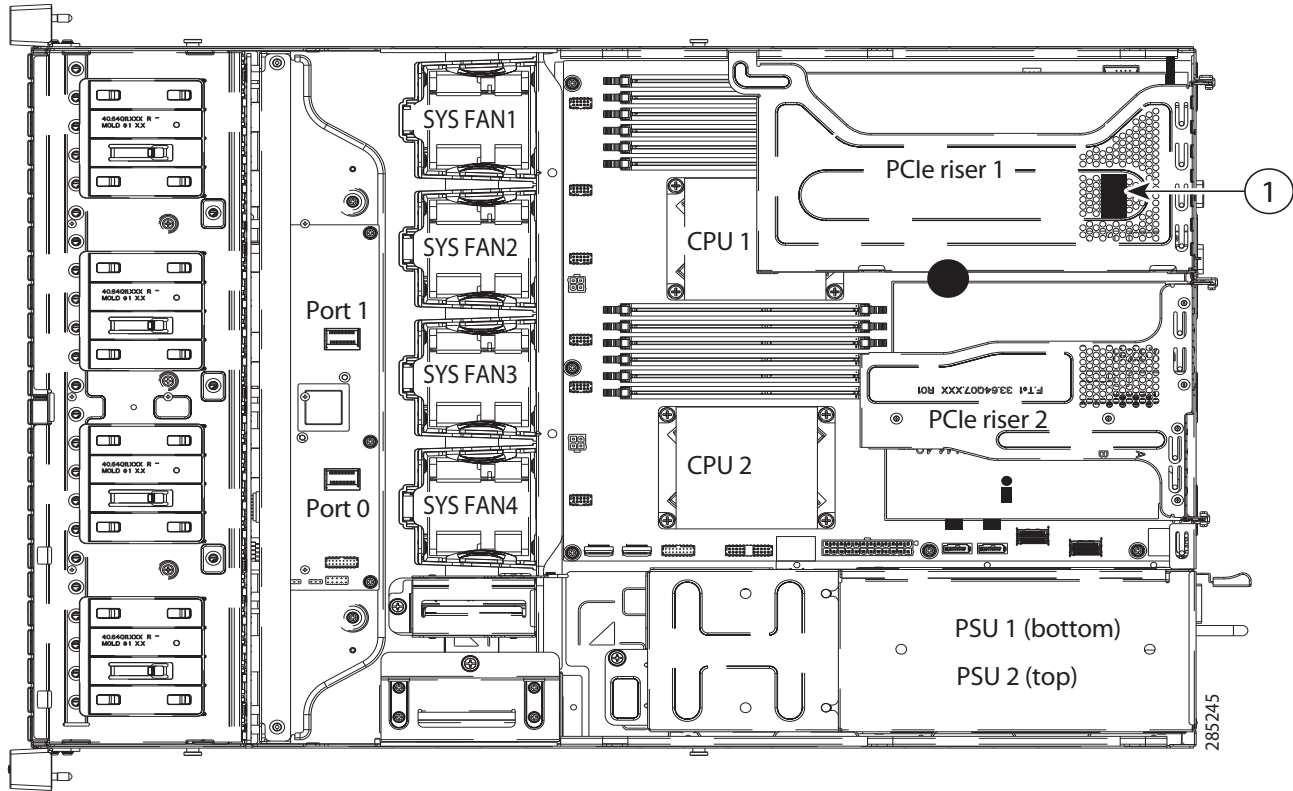

1	USB 2.0 port on motherboard	-	-
---	-----------------------------	---	---

LED Indicators

The server contains LED indicators on the front and rear panels. Their functions are described in the following sections.

Front Panel

Figure 11 shows the front panel LEDs.

Figure 11 Front Panel LEDs

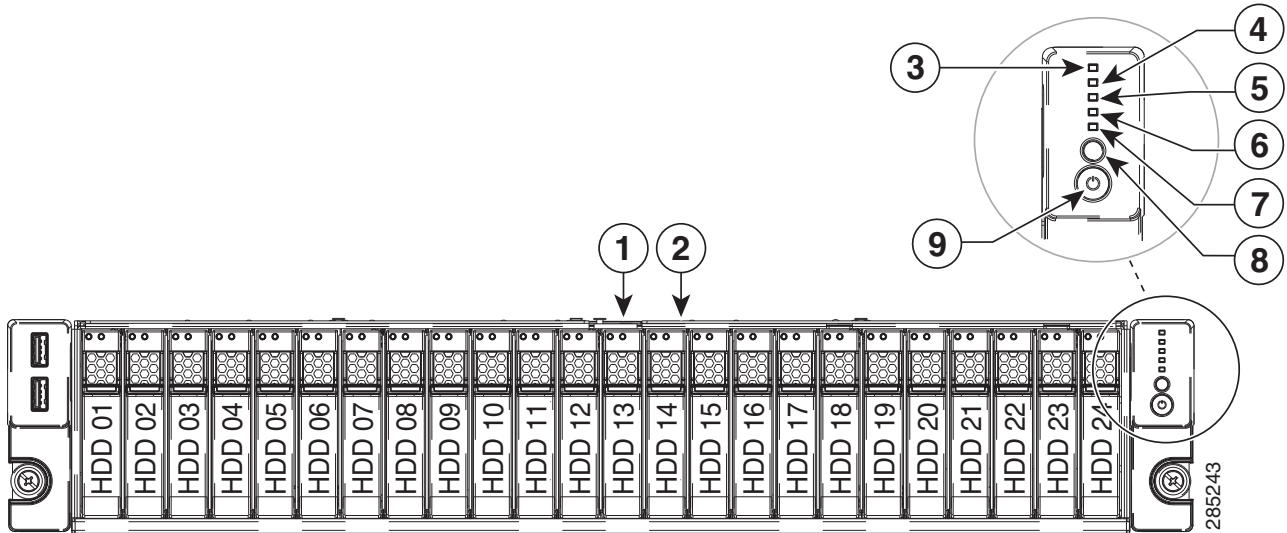

1	Hard drive fault LED	6	Fan status LED
2	Hard drive activity LED	7	System status LED
3	Network link activity LED	8	Identification button/LED
4	Power supply status LED	9	Power button/power status LED
5	Temperature status LED	-	-

See Table 26 for the functions of the front panel LEDs.

Table 26 Front Panel LEDs

LED	LED State	Meaning
Hard Drive Fault	Off	The hard drive is operating properly
	On (amber)	The hard drive has failed
	Blinking (amber)	The hard drive is rebuilding

Table 26 Front Panel LEDs (continued)

LED	LED State	Meaning
Hard Drive Activity	Off	There is no hard drive in the hard drive sled (no access, no fault)
	On (green)	The hard drive is ready
	Blinking (green)	The hard drive is reading or writing data
Network Link Status	Off	Undefined
	On (green)	Link pulses detected on any of the LOM ports, but no activity.
	Blinking (green)	Activity on any of the LOM ports
Temperature Status	Off	Undefined
	On (green)	System is operating at normal temperature and no error conditions have been detected.
	On (amber)	One or more temperature sensors exceeded a warning threshold.
	Blinking (amber)	One or more temperature sensors exceeded a critical threshold
Fan Status	Off	Undefined
	On (green)	Fans are operating and no error condition has been detected
	On (amber)	Fans are in a degraded operational state, indicating that one of the fans has a fault.
	Blinking (amber)	Critical fault state, indicating that two or more fans have a fault.
System Status	Off	Undefined
	On (green)	Server is in normal operating condition
	On (amber)	Server is in a degraded operational state. For example: <ul style="list-style-type: none"> ■ Power supply redundancy is lost. ■ CPUs are mismatched. ■ At least one CPU is faulty. ■ At least one DIMM is faulty. ■ At least one drive in a RAID configuration failed.
	Blinking (amber)	Server is in a critical fault state. For example: <ul style="list-style-type: none"> ■ Boot failed. ■ Fatal CPU and/or bus error is detected. ■ Server is in over-temperature condition

Table 26 Front Panel LEDs (continued)

LED	LED State	Meaning
Unit ID (LED is integrated into unit ID button)	Off	Unit ID not active
	On (blue)	Unit ID is activated
Power (LED is integrated into power button)	Off	Server power is off
	On (amber)	Server power is soft off (power is supplied only to the CIMC and some motherboard functions)
	On (green)	Card power is on

Rear Panel

Figure 12 shows the rear panel LEDs.

Figure 12 Rear Panel LEDs

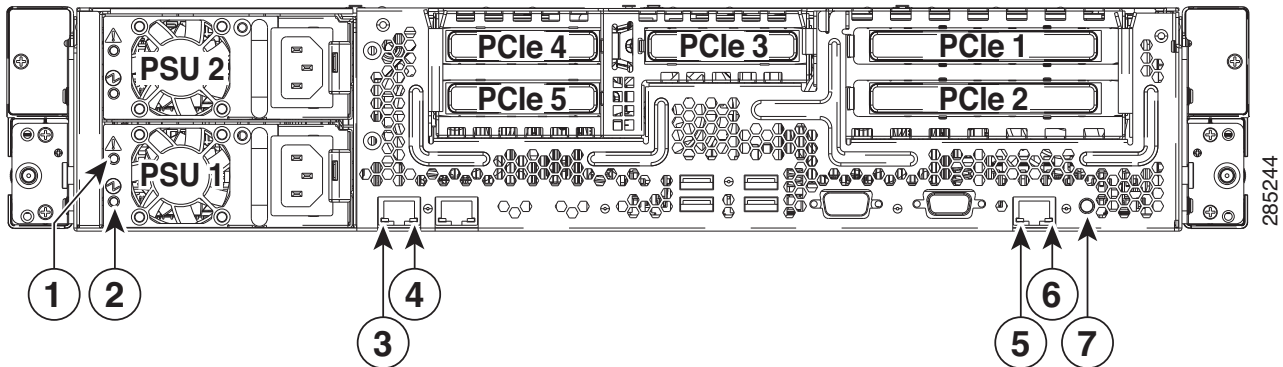

1	Power supply fault LED	5	10/100/1000 Ethernet dedicated management link status LED
2	Power supply AC OK LED	6	10/100/1000 Ethernet dedicated management link speed LED
3	1-GbE link speed LED	7	Identification button/LED
4	1-GbE link status LED	-	-

See [Table 27](#) for the functions of the rear panel LEDs.

Table 27 Rear Panel LEDs

LED	LED State	Meaning
Power Supply Fault	Off	The power supply is operating normally
	Blinking (amber)	An event warning threshold has been reached, but the power supply continues to operate
	On (amber)	A critical fault threshold has been reached, causing the power supply to shut down (for example, a fan failure or an over-temperature condition).
Power Supply AC	Off	There is no AC power to the power supply
	Blinking (green)	AC power OK, DC output not enabled
	On (green)	AC power OK, DC outputs OK
1 GbE Link Speed	Off	Link Speed = 10 Mbps
	On (amber)	Link Speed = 100 Mbps
	On (green)	Link Speed = 1 Gbps
1 GbE Link Status	Off	No Link
	On (green)	Link is active
	Blinking (green)	Traffic is present on the active link
10/100/1000 Base-T Link Speed	Off	Link Speed = 10 Mbps
	On (amber)	Link Speed = 100 Mbps
	On (green)	Link Speed = 1 Gbps
10/100/1000 Base-T Link Status	Off	No Link
	On (green)	Link is active
	Blinking (green)	Traffic is present on the active link
Unit ID (LED is integrated into unit ID button)	Off	Unit ID not active
	On (blue)	Unit ID is activated

TECHNICAL SPECIFICATIONS

Dimensions and Weight

Table 28 UCS C24 M3 Dimensions and Weight

Parameter	Value
Height	3.45 in (87.6 mm)
Width	16.93 in.(430 mm)
Depth	26.0 in. (660.5 mm)
Front Clearance	3 in. (76 mm)
Side Clearance	1 in. (25 mm)
Rear Clearance	9 in. (233 mm)
Weight	
Maximum (24 HDDs, 2 CPUs, 12 DIMMs, 2 power supplies)	47.18 lbs (21.4 kg)
Bare (0 HDD, 0 CPU, 0 DIMM, no power supply)	34.5 lbs (15.65 kg)

Power Specifications

The general power specifications for the C24 M3 SFF server 450 W power supply are listed in [Table 29](#).

Table 29 UCS C24 M3 SFF 450 W Power Supply Specifications

Description	Specification
AC input voltage	90 to 264 VAC self-ranging, 100 to 120 VAC nominal 200 to 240 VAC nominal
AC input frequency	Range: 47 to 63 Hz (single phase, 50 to 60 Hz nominal)
Maximum AC input current	6 A maximum at 100 VAC 3 A maximum at 208 VAC
Maximum AC inrush current	9 A peak @ 35° C, 208 VAC
Maximum output power for the power supply	450 W
Power supply output voltage	Main power: 12 VDC Standby power: 12 VDC
Power supply efficiency	CSCI Platinum



NOTE: AC input connector is an IEC 320 C-14 15A/250VAC power inlet.

The general power specifications for the C24 M3 SFF server 650 W power supply are listed in [Table 29](#).

Table 30 UCS C24 M3 SFF 650 W Power Supply Specifications

Description	Specification
AC input voltage	90 to 264 VAC self-ranging, 100 to 120 VAC nominal 200 to 240 VAC nominal
AC input frequency	Range: 47 to 63 Hz (single phase, 50 to 60 Hz nominal)
Maximum AC input current	7.6 A maximum at 100 VAC 3.65 A maximum at 208 VAC
Maximum AC inrush current	11 A peak @ 35° C, 208 VAC
Maximum output power for the power supply	650 W
Power supply output voltage	Main power: 12 VDC Standby power: 12 VDC
Power supply efficiency	CSCI Platinum



NOTE: AC input connector is an IEC 320 C-14 15A/250VAC power inlet.

For configuration-specific power specifications, use the Cisco UCS Power Calculator at this URL:

<https://express.salire.com/Go/Cisco/Cisco-UCS-Power-Calculator.aspx>

Environmental Specifications

The power specifications for the C24 M3 server are listed in [Table 31](#).

Table 31 UCS C24 M3 Environmental Specifications

Parameter	Minimum
Temperature operating	41 to 104° F (5 to 40° C) derate the maximum temperature by 1°C per every 305m of altitude above sea level
Temperature nonoperating	-40 to 149°F (-40 to 65°C)
Humidity (RH) nonoperating, non-condensing	10 to 90%
Altitude operating	0 to 3,000 m (0 to 10,000 ft.)
Altitude nonoperating	0 to 12,192 m (0 to 40,000 ft.)
Sound Power level, Measure A-weighted per ISO7779 LWAd (Bels) Operation at 73°F (23°C)	5.9
Sound Pressure level, Measure A-weighted per ISO7779 LpAm (dBA) Operation at 73°F (23°C)	46

Compliance Requirements

The regulatory compliance requirements for C-Series servers are listed in [Table 32](#).

Table 32 UCS C-Series Regulatory Compliance Requirements

Parameter	Description
Regulatory Compliance	Products should comply with CE Markings per directives 2004/108/EC and 2006/95/EC
Safety	UL 60950-1 Second Edition CAN/CSA-C22.2 No. 60950-1 Second Edition EN 60950-1 Second Edition IEC 60950-1 Second Edition AS/NZS 60950-1 GB4943 2001
EMC - Emissions	47CFR Part 15 (CFR 47) Class A AS/NZS CISPR22 Class A CISPR22 Class A EN55022 Class A ICES003 Class A VCCI Class A EN61000-3-2 EN61000-3-3 KN22 Class A CNS13438 Class A
EMC - Immunity	EN55024 CISPR24 EN300386 KN24



Americas Headquarters
Cisco Systems, Inc.
San Jose, CA

Asia Pacific Headquarters
Cisco Systems (USA) Pte. Ltd.
Singapore

Europe Headquarters
Cisco Systems International BV Amsterdam,
The Netherlands

Cisco has more than 200 offices worldwide. Addresses, phone numbers, and fax numbers are listed on the Cisco Website at www.cisco.com/go/offices.

Cisco and the Cisco Logo are trademarks of Cisco Systems, Inc. and/or its affiliates in the U.S. and other countries. A listing of Cisco's trademarks can be found at www.cisco.com/go/trademarks. Third party trademarks mentioned are the property of their respective owners. The use of the word partner does not imply a partnership relationship between Cisco and any other company. (1005R)